

"Virtua Tennis 4 2P VERSION" DIFFERENCES EXPLANATION/SOFTWARE INSTALL MANUAL

This manual explains how to substitute the software "Virtua Tennis 4 2P VERSION" for "Virtua Tennis 4," and which areas of the specifications differ from "Virtua Tennis 4" once substituted. Read this manual along with the Service Manual included with "Virtua Tennis 4."

This manual is intended for the owners, personnel and managers in charge of operation of the product. Read this manual carefully and sufficiently understanding the instructions, along with the instruction manual for the cabinet, before beginning the software installing work.

In the unlikely event that the product does not function correctly, DO NOT allow anyone other than a technician to touch the internal system. Turn off the power to the product, making sure to unplug the electrical cord from the outlet, and contact the office listed in the Service Manual or the point-of-purchase for this product.

Use of this product is unlikely to cause physical injuries or damage to property. However, points that require special attention are indicated by bold text, the word "IMPORTANT" and the symbol below.

STOP **IMPORTANT**

Indicates important information that, if ignored, may result in the mishandling of the product and cause faulty operation or damage to the product.

Definition of 'Site Maintenance Personnel or Other Qualified Individuals'

WARNING

Procedures not described in this manual or marked as 'to be carried out by site maintenance personnel or other qualified professionals' should not be carried out by personnel without the necessary skill or technology. Work carried out by unqualified persons may cause serious accidents, including electrocution.

Parts replacement, maintenance inspections and troubleshooting should be carried out by site maintenance personnel or other qualified professionals. This manual includes directions for potentially dangerous procedures which should only be carried out by professionals with the appropriate specialized knowledge.

The site maintenance personnel or other qualified professionals mentioned in this manual are defined as follows:

Site maintenance personnel:

Individuals with experience in maintaining amusement equipment, vending machines, etc., working under the supervision of the owner/operator of this product to maintain machines within amusement facilities or similar premises by carrying out everyday procedures such as assembly, maintenance inspections, and replacement of units/ expendable parts.

Activities to be carried out by site maintenance personnel:

Amusement equipment/vending machine assembly, maintenance inspection and replacement of units/expendable parts.

Other qualified professionals:

Persons employed by amusement equipment manufacturers, or involved in design, production, testing or maintenance of amusement equipment. The individual should have either graduated from technical school or hold similar qualifications in electrical/electronics/mechanical engineering.

Activities to be carried out by other qualified professionals:

Amusement equipment/vending machine assembly, repair/adjustment of electrical/electronic/mechanical parts.

1 KIT CONTENTS

This software kit (XKT-1956-D-EX1) is intended for use with the "Virtua Tennis 4 2P VERSION."
Check that the kit parts listed hereafter are present before performing any work.

■ Kit number : XKT-1956-D-EX1 [DVD-ROM KIT VT4 2P VER]

Parts not labeled with part numbers are as yet unregistered or cannot be registered. Be sure to handle all parts with care, as some parts are not available for purchase separately.

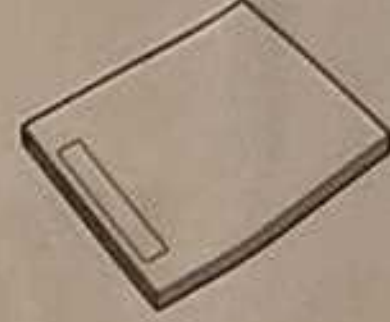
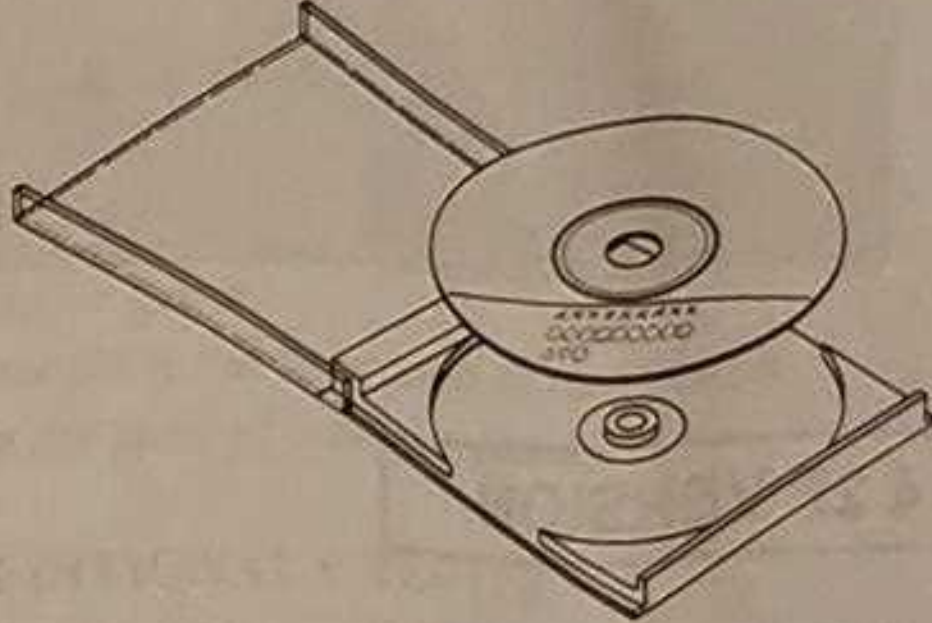
Part name/Part no.	Diagram/Use etc.	Quantity
INSTALLATION MANUAL 421-12936-01	 This document	1
DVD SOFTWARE KIT DVR-0057		1

2 ABOUT "Virtua Tennis 4 2P VERSION"

Substituting "Virtua Tennis 4 2P VERSION" for "Virtua Tennis 4" enables joinable versus matches. "Doubles Mode" and "Mini Game Mode" will no longer appear, and the maximum number of players will be limited to 2, so install the software versions according to your preference.

NOTE: "Virtua Tennis 4 2P VERSION" displays "2P VERSION" in the lower section of the TITLE LOGO screen.

Virtua Tennis 4

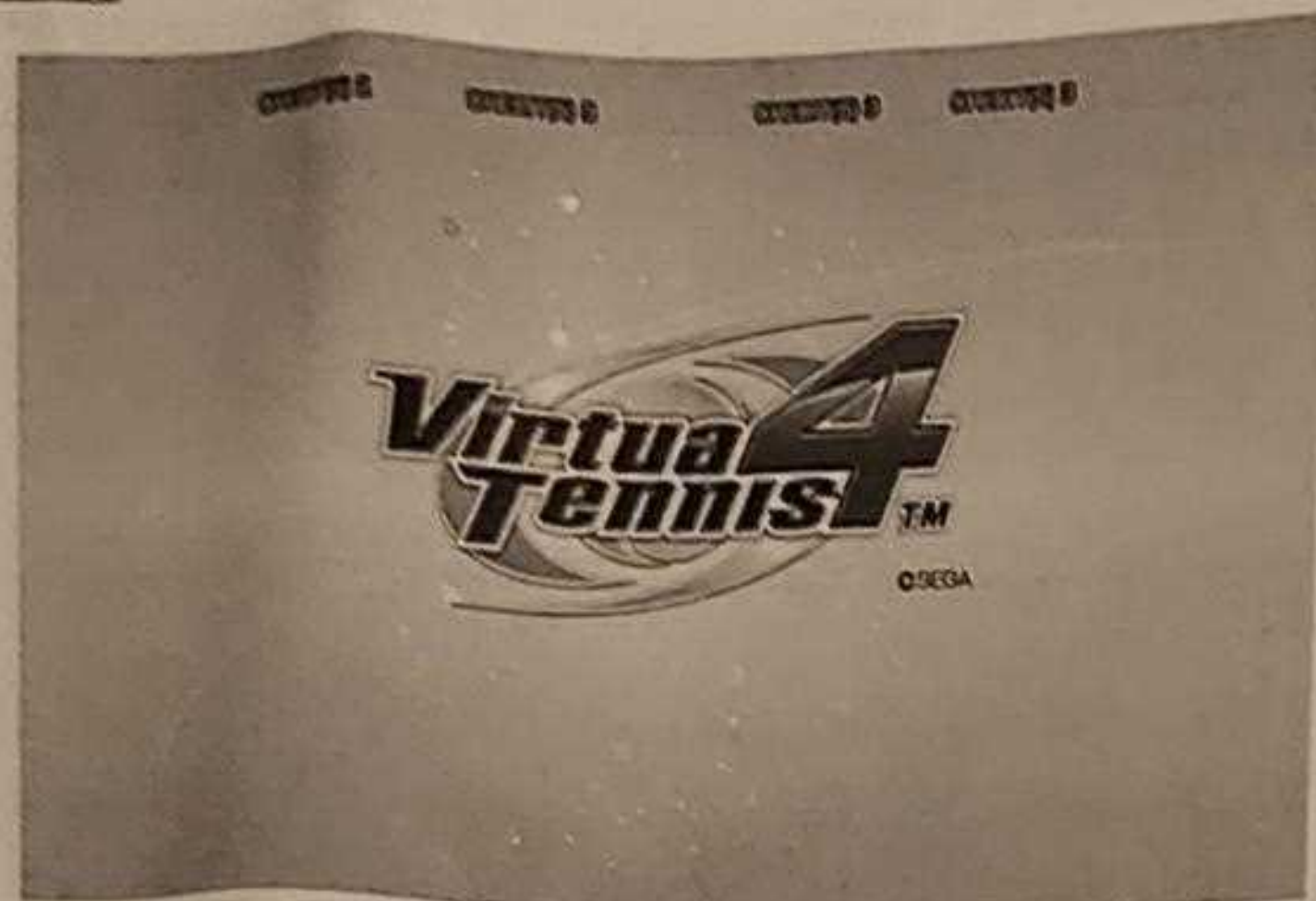

Virtua Tennis 4 2P VERSION

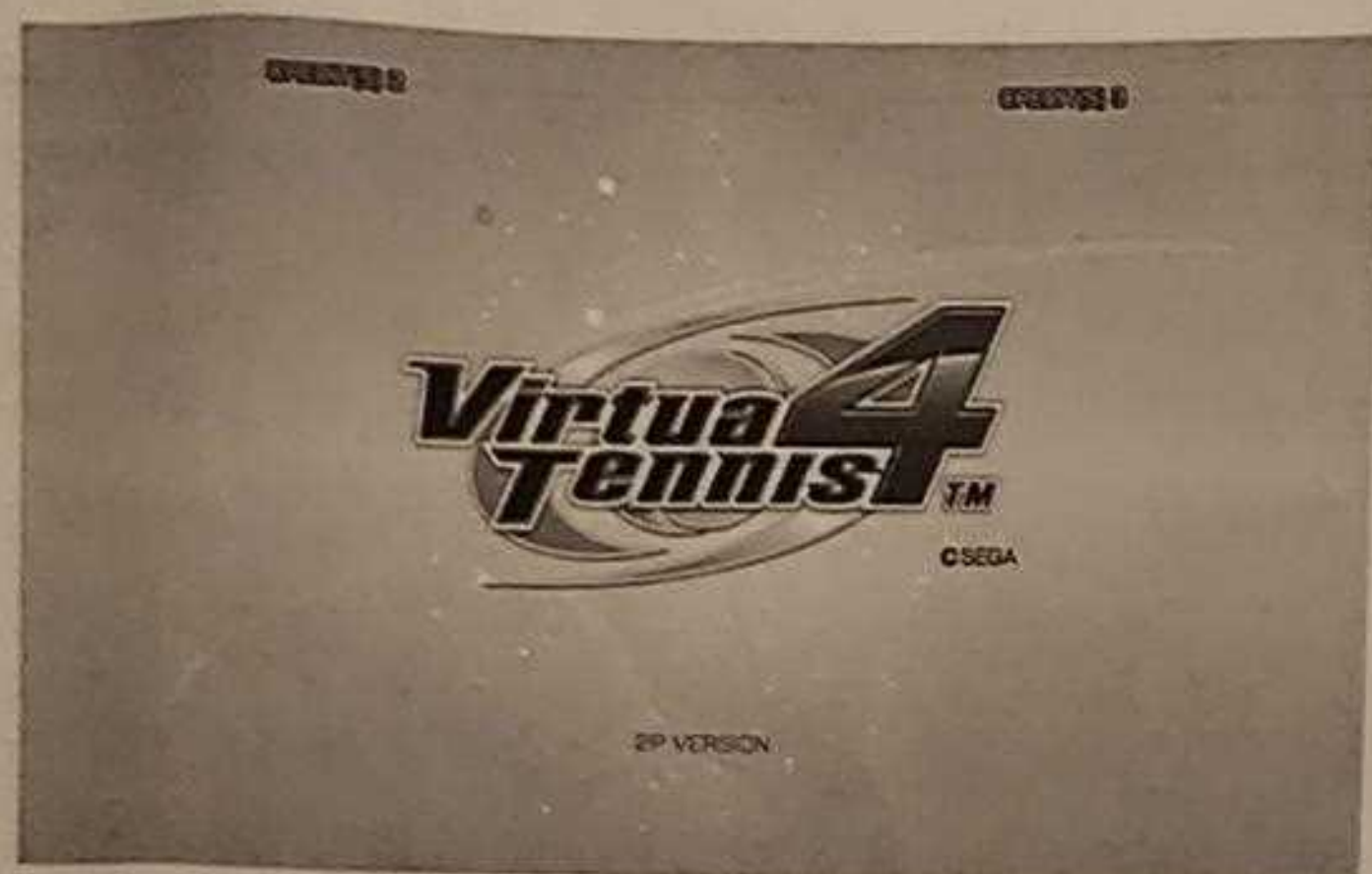

3 CHANGES FROM "Virtua Tennis 4" (OVERVIEW)

3-1 GAME CONTENTS

■ **JOINABLE VERSUS MATCH FEATURE ADDED**
Joinable versus matches are possible during 1-player play.

■ **MODE CHANGES**
The following modes will no longer appear.
1. Doubles Mode
2. Mini Game Mode

■ **SCREEN CHANGES**
The following screens will no longer appear.
1. Main Menu screen
2. Position Select screen

■ **CHANGES TO MAXIMUM NUMBER OF PLAYERS**
Supports a maximum 2 players.

■ **WINNER STAYS ON FEATURE ADDED**
In versus matches between players, the winner can continue playing 1-player.

NOTES:

- The player who was joined can continue their 1-player game.
- If they were joined during a match, play will resume from the beginning of that match.
- If the player who joined wins, they will begin from the start of 1-player game.

■ **1-PLAYER MODE DOES NOT REQUIRE ADDITIONAL CREDITS**
After winning a match in 1-player mode, the player can continue to the next match without inserting additional credits.

3-2 GAME TEST MODE

■ **INPUT TEST**
Since the maximum number of players is 2, the "3" and "4" items will no longer appear.

■ **GAME ASSIGNMENTS**
The "SHORT MODE" item will no longer appear.

4 CHANGES TO "Virtua Tennis 4" SERVICE MANUAL (420-7360-01)

P. 2

2 GAME CONTENTS

2-1 GETTING STARTED

The following details are changed.

Supports a maximum 4 players. → Supports a maximum 2 players.

2-2 GAME FLOW

Game flow proceeds as follows.

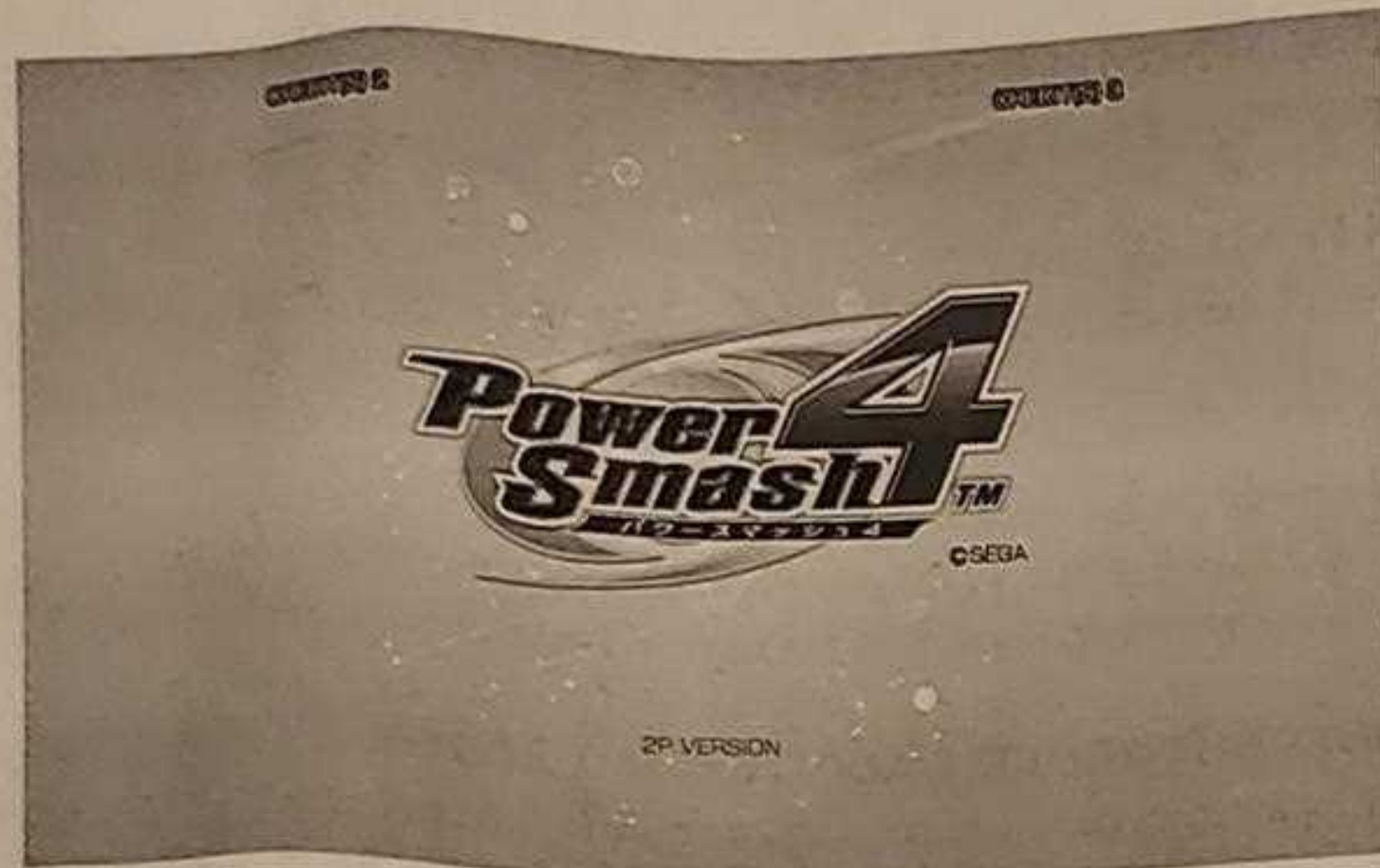

ADVERTISE MODE screen

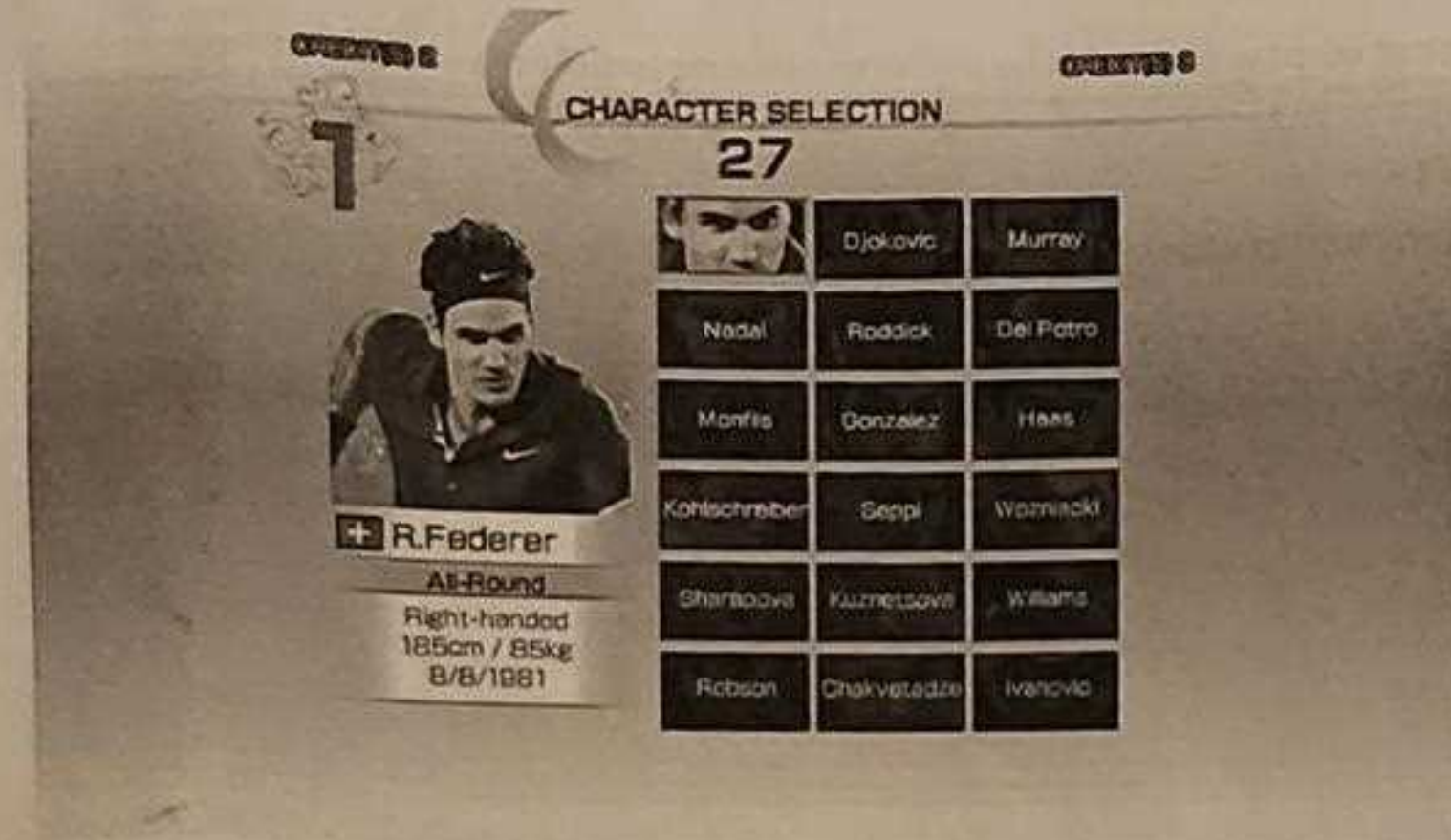

CHARACTER SELECT screen

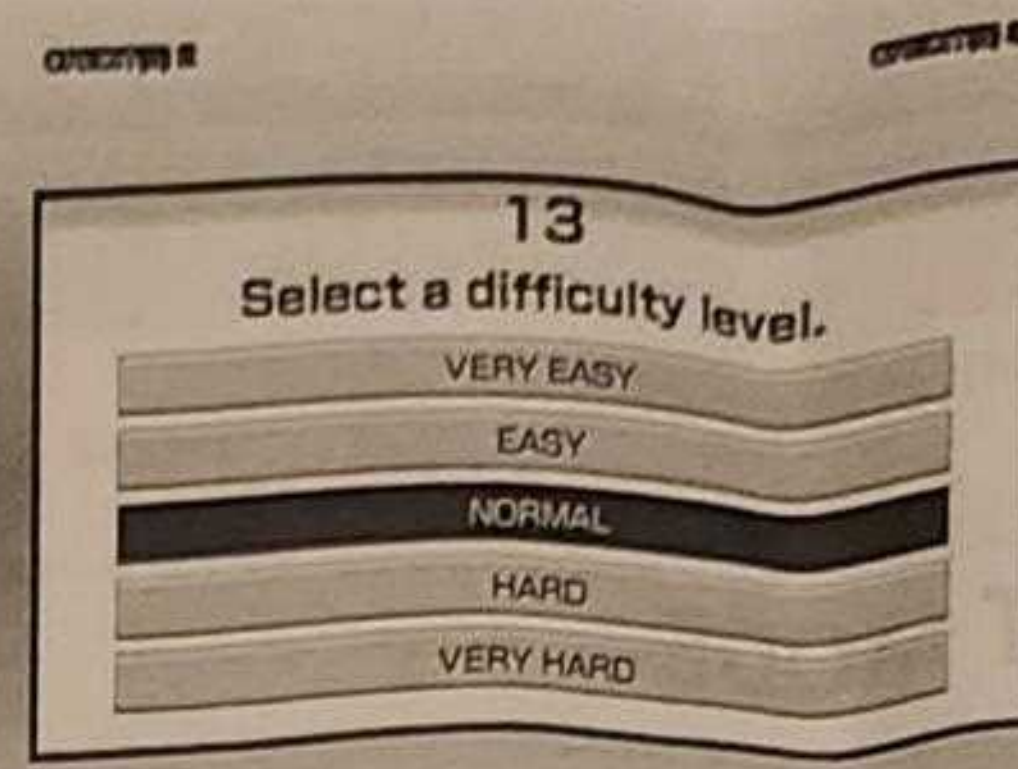

DIFFICULTY SETTING screen

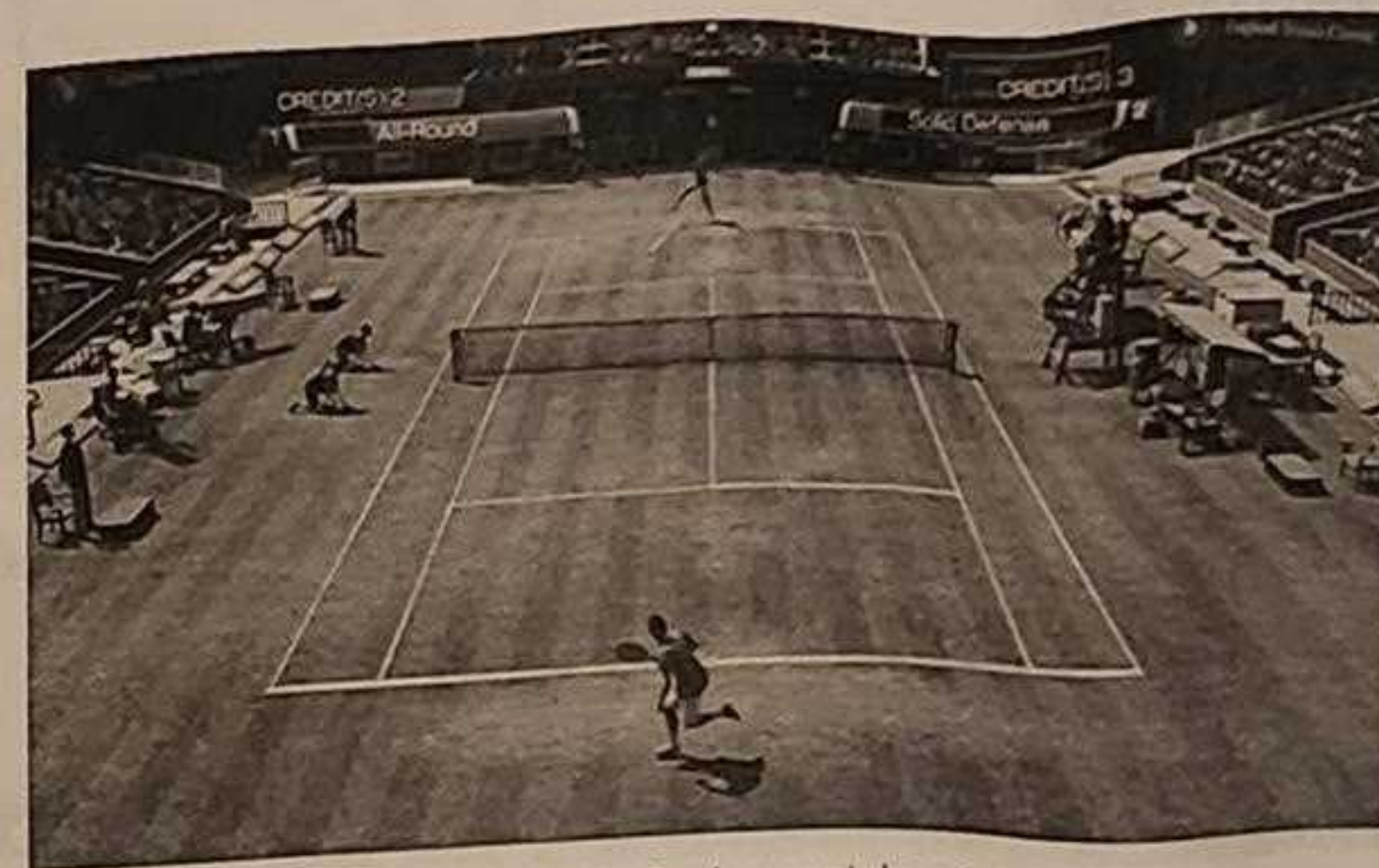

1-PLAYER VS CPU MODE (5 singles matches total)



WHEN JOINED FOR A VERSUS MATCH

2-4 MATCH SCREEN

- "Doubles Mode" will no longer appear.
- "Mini Game Mode (1 Player)" will no longer appear.
- "Mini Game Mode (Multiplayer)" will no longer appear.

3 SYSTEM TEST MODE

COIN ASSIGNMENTS

<Operation examples>

Settings are as follows.

- **2 cabinets, maximum 2 players, 2 coin slots available**
Set to INDIVIDUAL.
- **1 cabinet, maximum 2 players, 2 coin slots available**
Set to INDIVIDUAL.
- **1 cabinet, maximum 2 players, 1 coin slots available**
Set to COMMON.
NOTE: However, note that this will mean credits are shared.
If set to INDIVIDUAL, then START button number 2 will stop functioning.

4 GAME TEST MODE

4-3 INPUT TEST

The INPUT TEST screen changes as follows.

INPUT TEST		
PLAYER	1P	2P
UP	OFF	OFF
DOWN	OFF	OFF
RIGHT	OFF	OFF
LEFT	OFF	OFF
SHOT1	OFF	OFF
SHOT2	OFF	OFF
SHOT3	OFF	OFF
START	OFF	OFF
SERVICE	OFF	
TEST	OFF	

PRESS TEST AND SERVICE BUTTON TO EXIT

The following sentence will no longer appear.

"If the number of connected I/O boards is 1, the 1P and 2P displays will flash. If the number is 2, all displays from 1P to 4P will flash."

4-5 GAME ASSIGNMENTS

The GAME ASSIGNMENTS screen changes as follows.

GAME ASSIGNMENTS	
LANGUAGE	ENG
ADVERTISE SOUND	ON
SPEED INDICATOR	km/h
DEUCE	OFF
> EXIT	
SELECT WITH SERVICE BUTTON AND PRESS TEST BUTTON	

Menu Items

The SHORT MODE item will no longer appear.

5 SOFTWARE INSTALLATION

There are no changes to the BOOKKEEPING values after substituting the software "Virtua Tennis 4 2P VERSION" for "Virtua Tennis 4." All types of ranking data will be saved, and shared ranking data is common to both. Mini game ranking data is not displayed in "Virtua Tennis 4 2P VERSION." Refer to the RINGEDGE Service Manual when installing software, and uninstall the currently installed software before proceeding.

Installation takes about 15 minutes. If you observe a phenomenon not described in this manual after 30 minutes have passed, contact the office listed in Service Manual. If an OS update is necessary, it will be performed simultaneously with the software update and the system will automatically reboot. The screen will indicate when a reboot is in progress. Performing an OS update and rebooting the system requires additional time.

STOP IMPORTANT

The NH6P connector of the DVD cable is not used. Do not connect it to any open connectors.

To install RINGEDGE software, ready the installation cable, DVD drive, and DVD cable, then follow the instructions below to connect the DVD drive.

- 1 Turn OFF the power switch on the cabinet.
- 2 Open the door to the section that contains the RINGEDGE.
- 3 Connect the installation cable connector to the RINGEDGE.

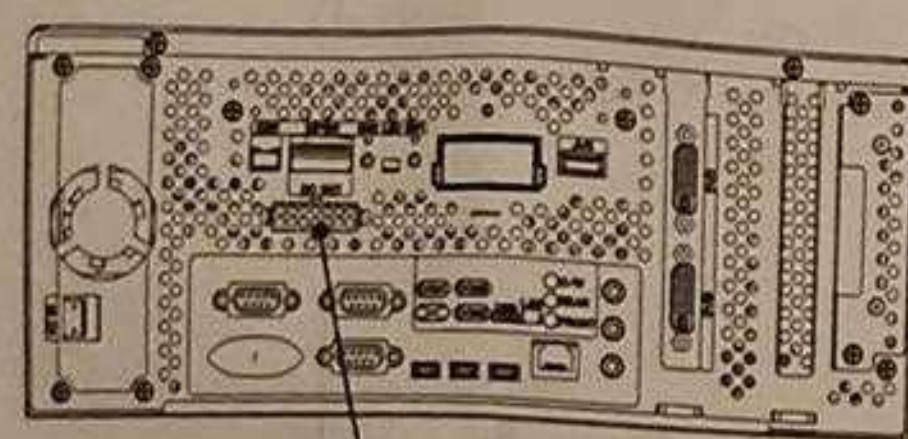

CONNECTOR
MOLEX14P

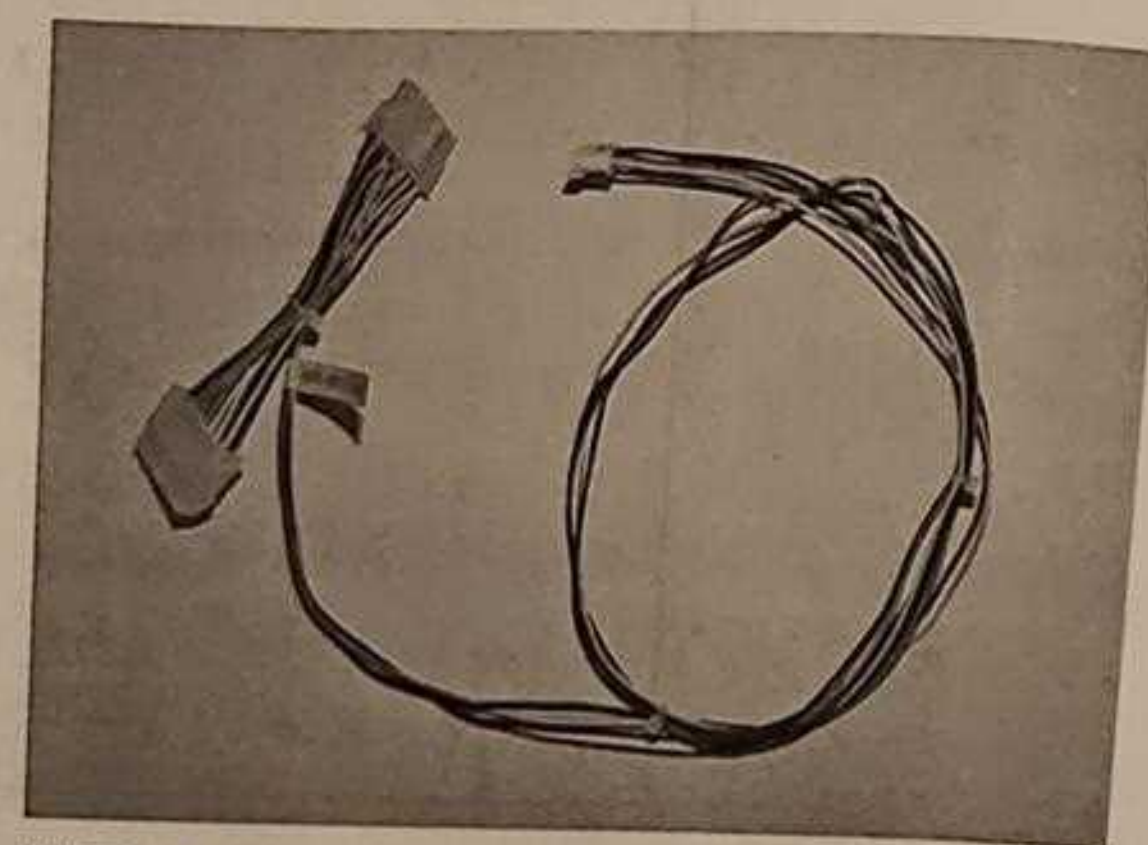

INSTALLATION CABLE

- 4 Connect the connector at the end of the DVD cable bearing the LINDBERGH tag. The remaining connector at that end of the cable (NH6P) is not used.

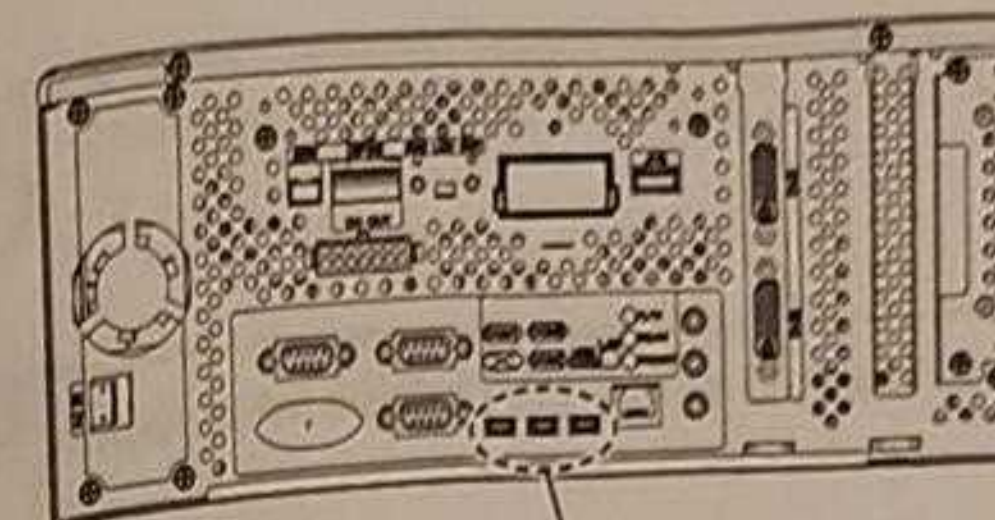

CONNECTOR
USB MINI A

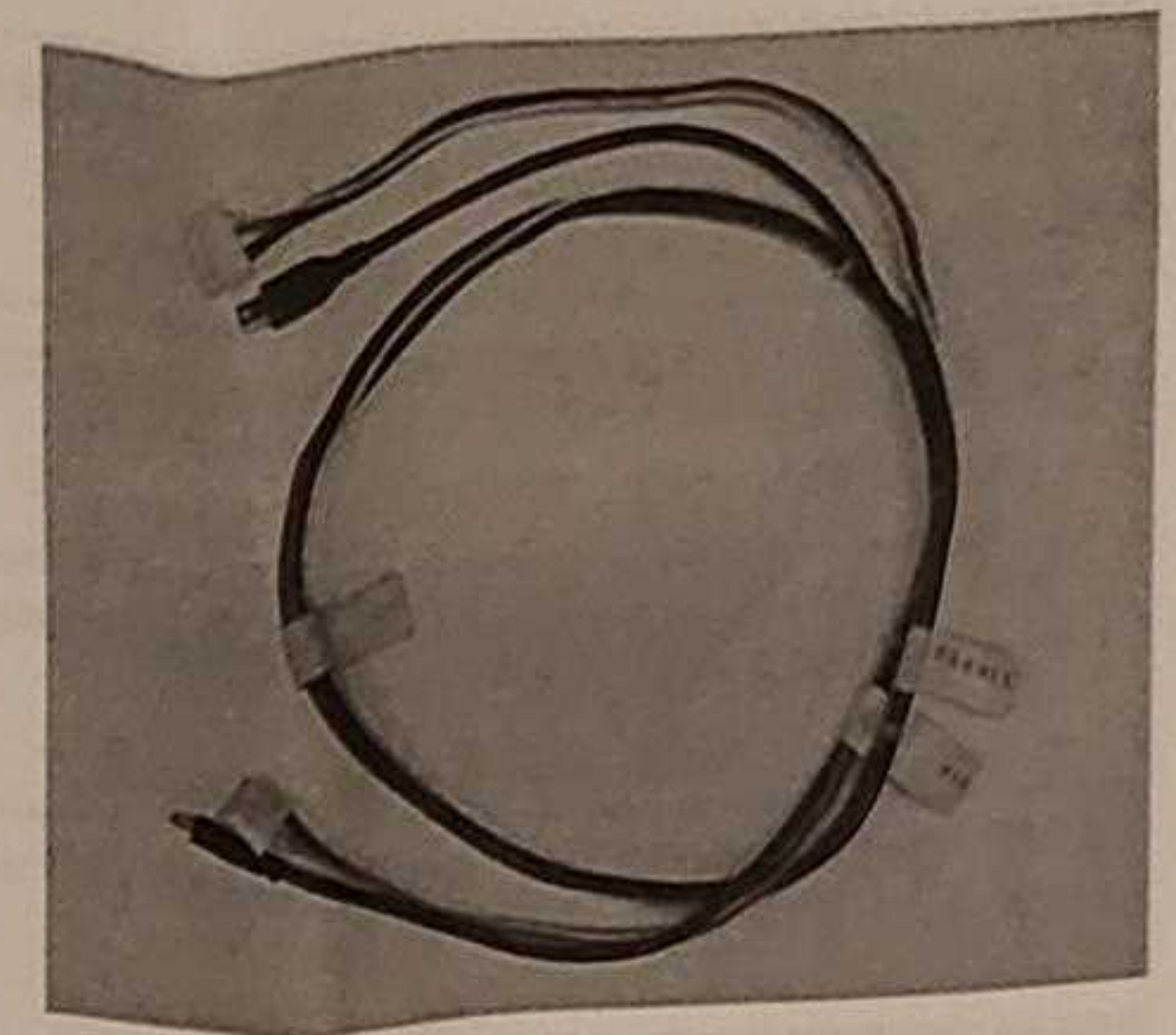

DVD CABLE

- 5 Connect the installation cable connector to the rear of the DVD drive.

CONNECTOR
NH6P

INSTALLATION CABLE

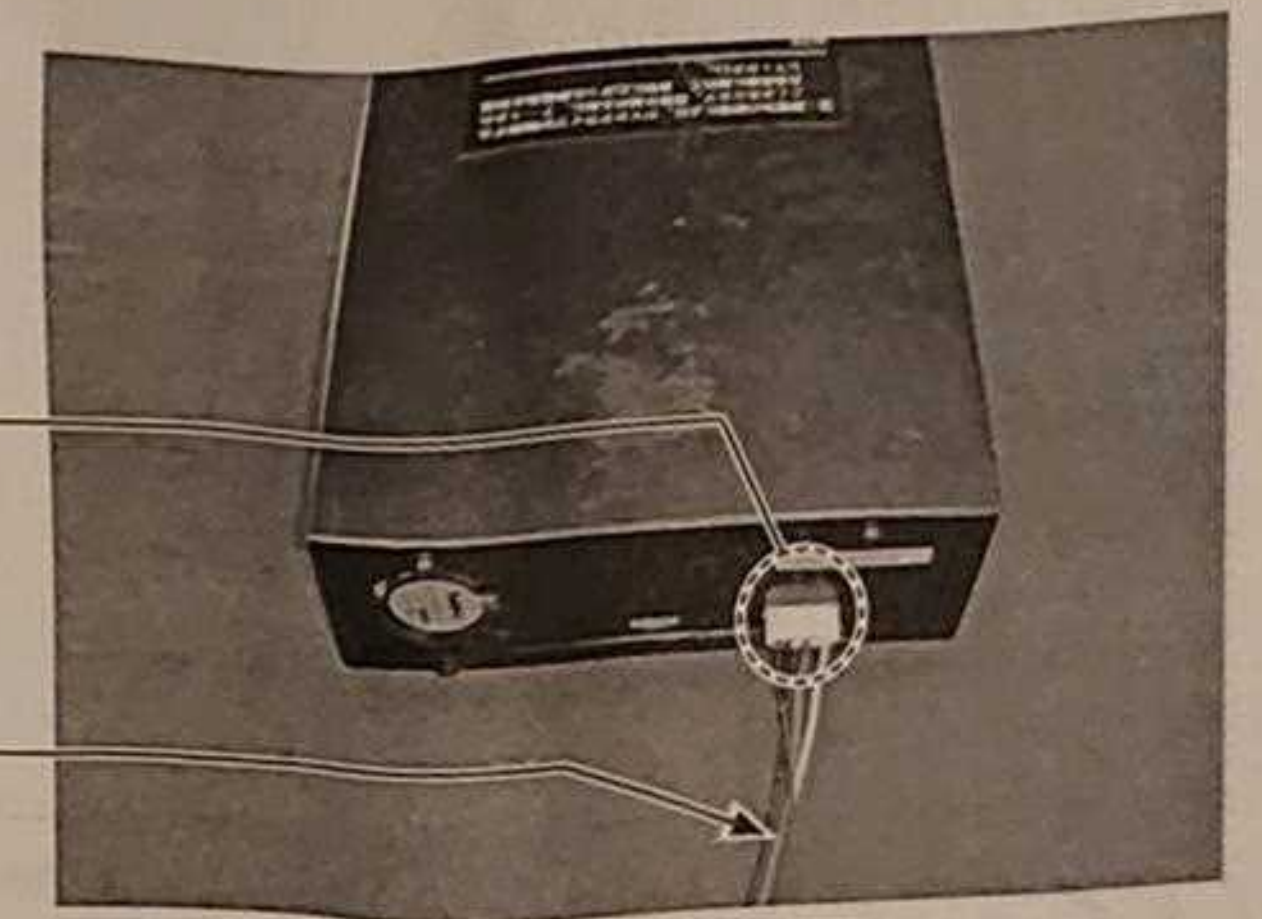

- 6 Connect the DVD cable connector to the rear of the DVD drive.
NOTE: The remaining NH6P connector is not used.

CONNECTOR
USB MINI B

The NH6P connector is not used.

DVD CABLE

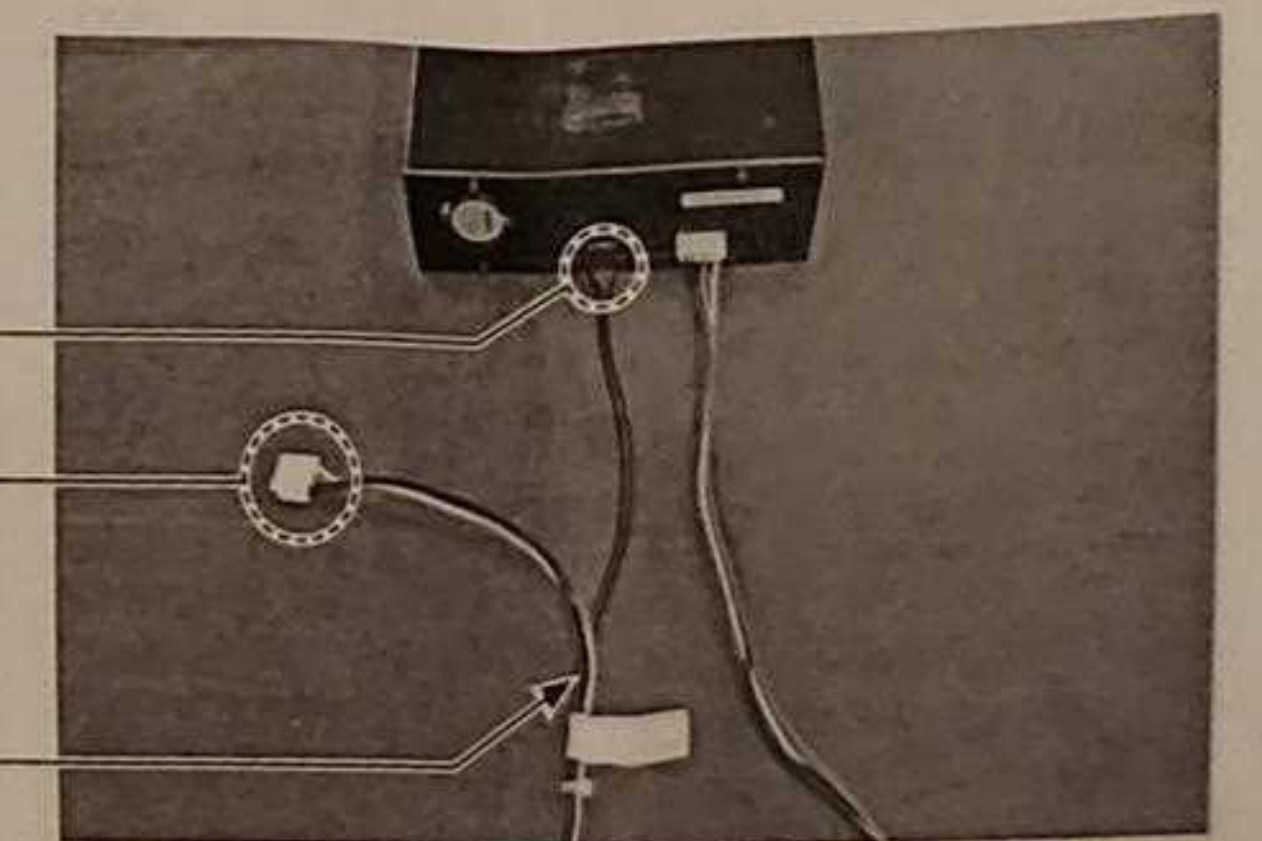

7 Be careful not to trap the cable when you close the door.

8 Turn the power switch on the cabinet connected to the DVD drive to ON.

9 The RINGEDGE startup image on the screen.

10 Wait for at least 1 minute. The monitor of the cabinet connected to the DVD drive will display "Please Insert Disc."

11 Remove 1 thumbscrew, and then take off DVD drive case lid.

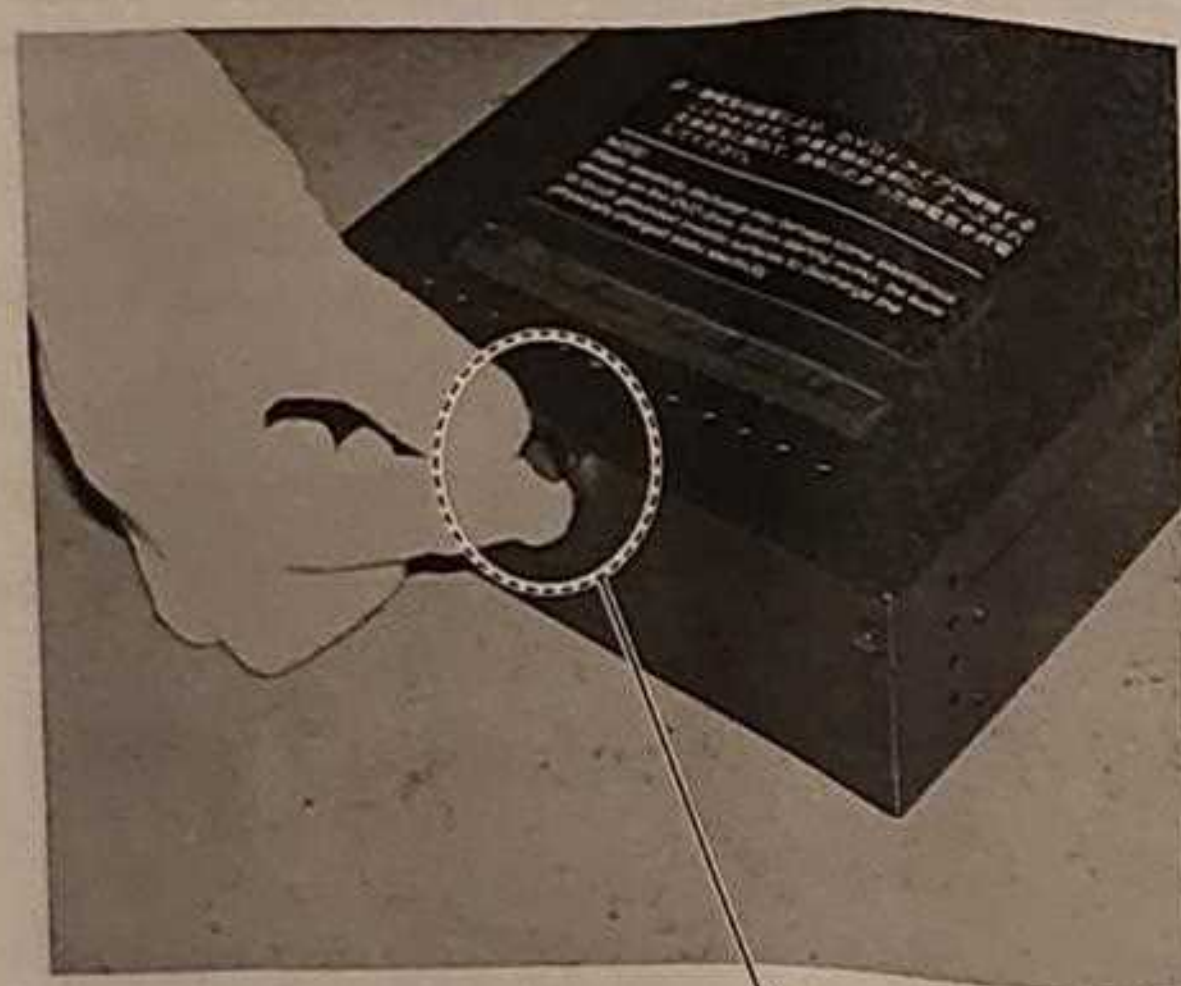

THUMBSCREW (1)



CASE LID

12 Press the DVD drive switch. The DVD drive tray comes out. Set the DVD from the DVD software kit into the tray. Always have the DVD label side facing upward.



DVD

13 Press the DVD drive switch to have the tray return. Software installs automatically from the DVD to the RINGEDGE.

14 When the advertising screen is displayed, the initialization operation is complete.

15 Press the DVD drive switch to have the tray come out, and then remove the DVD.

16 Press the DVD drive switch to have the tray return. When the power is cut off the tray will not move.

17 Turn OFF the power switch on the cabinet.

18 Refer to Steps 2 to 7 and work in reverse order to take off the DVD drive.

19 Refer to Step 11 and work in reverse order to attach the case lid. Store the DVD drive, DVD cable, installation cable, and DVD software kit in a location free from dust and cigarette smoke.