

FLIPN!C™

ULTIMATE PINBALL



CAPCOM®



Warning:

Read Before Using Your PlayStation®2 Computer Entertainment System.

A very small percentage of individuals may experience epileptic seizures when exposed to certain light patterns or flashing lights. Exposure to certain patterns or backgrounds on a television screen or while playing video games, including games played on the PlayStation 2 console, may induce an epileptic seizure in these individuals. Certain conditions may induce previously undetected epileptic symptoms even in persons who have no history of prior seizures or epilepsy. If you, or anyone in your family, has an epileptic condition, consult your physician prior to playing. If you experience any of the following symptoms while playing a video game – dizziness, altered vision, eye or muscle twitches, loss of awareness, disorientation, any involuntary movement, or convulsions – IMMEDIATELY discontinue use and consult your physician before resuming play.

Warning to Owners of Projection Televisions:

Do not connect your PlayStation 2 console to a projection TV without first consulting the user manual for your projection TV, unless it is of the LCD type. Otherwise, it may permanently damage your TV screen.

Use of Unauthorized Product:

The use of software or peripherals not authorized by Sony Computer Entertainment America may damage your console and/or invalidate your warranty. Only official or licensed peripherals should be used in the controller ports or memory card slots.

Handling Your PlayStation 2 Format Disc:

- This disc is intended for use only with PlayStation 2 consoles with the NTSC U/C designation.
- Do not bend it, crush it or submerge it in liquids.
- Do not leave it in direct sunlight or near a radiator or other source of heat.
- Be sure to take an occasional rest break during extended play.
- Keep this disc clean. Always hold the disc by the edges and keep it in its protective case when not in use. Clean the disc with a lint-free, soft, dry cloth, wiping in straight lines from center to outer edge. Never use solvents or abrasive cleaners.

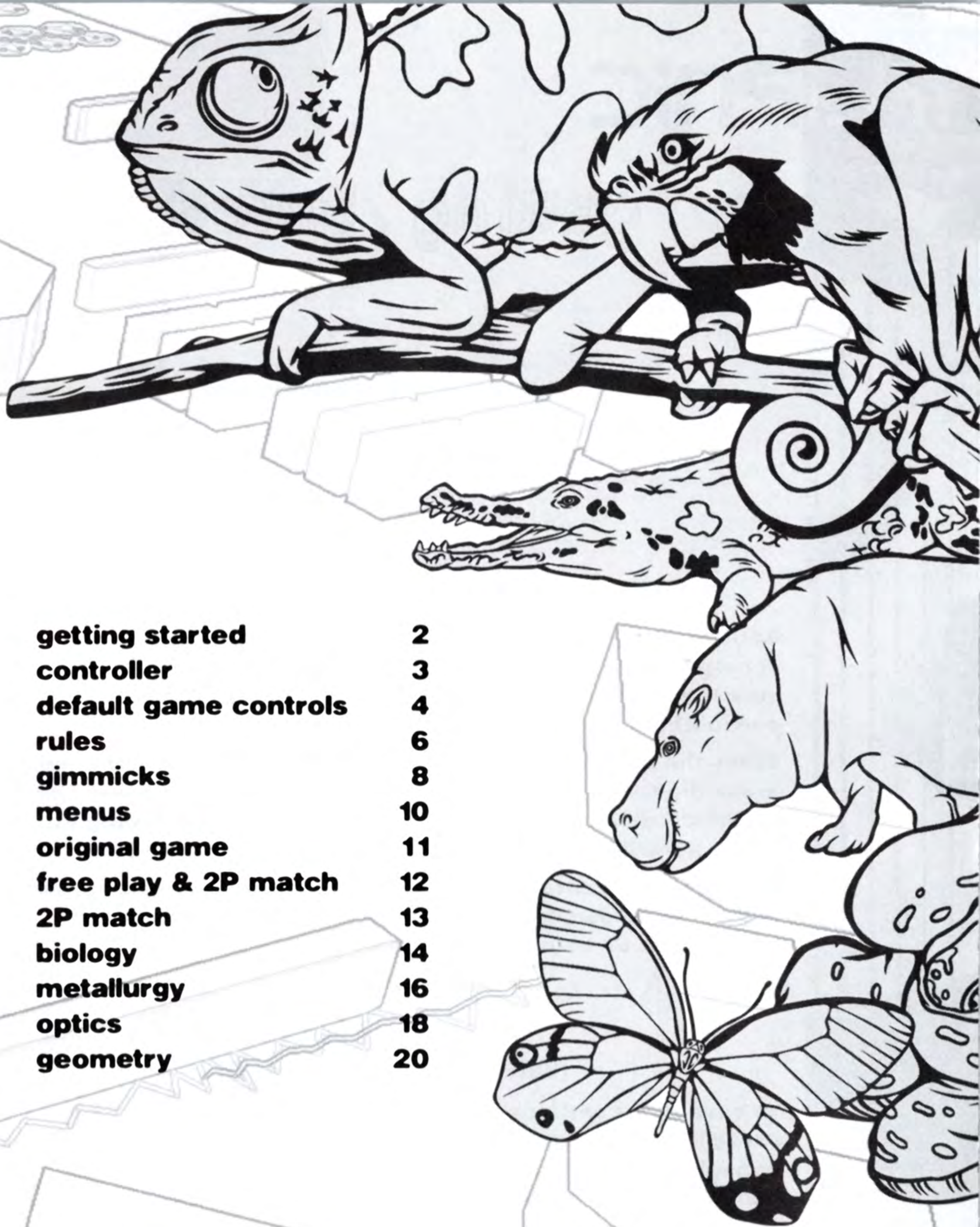

getting started	2
controller	3
default game controls	4
rules	6
gimmicks	8
menus	10
original game	11
free play & 2P match	12
2P match	13
biology	14
metallurgy	16
optics	18
geometry	20

A Special Message from **CAPCOM**

Thank you for selecting FLIPNIC™ for your PlayStation®2 computer entertainment system. CAPCOM is proud to bring you this new addition to your video game library.

CAPCOM ENTERTAINMENT, INC., 475 Oakmead Parkway, Sunnyvale, CA 94085.

© 2005 Sony Computer Entertainment Inc. All Rights Reserved. Published by Capcom Entertainment, Inc. ALL RIGHTS RESERVED. CAPCOM and the CAPCOM logo are registered trademarks of Capcom Co., Ltd. FLIPNIC is a trademark of Sony Computer Entertainment, Inc. The MPEG data in this software was made by TMPGenc. COPYRIGHT © HiroYuki Hori/Pegasys Inc., All Rights Reserved.

REGISTER ONLINE AT
www.capcom.com/register

getting started

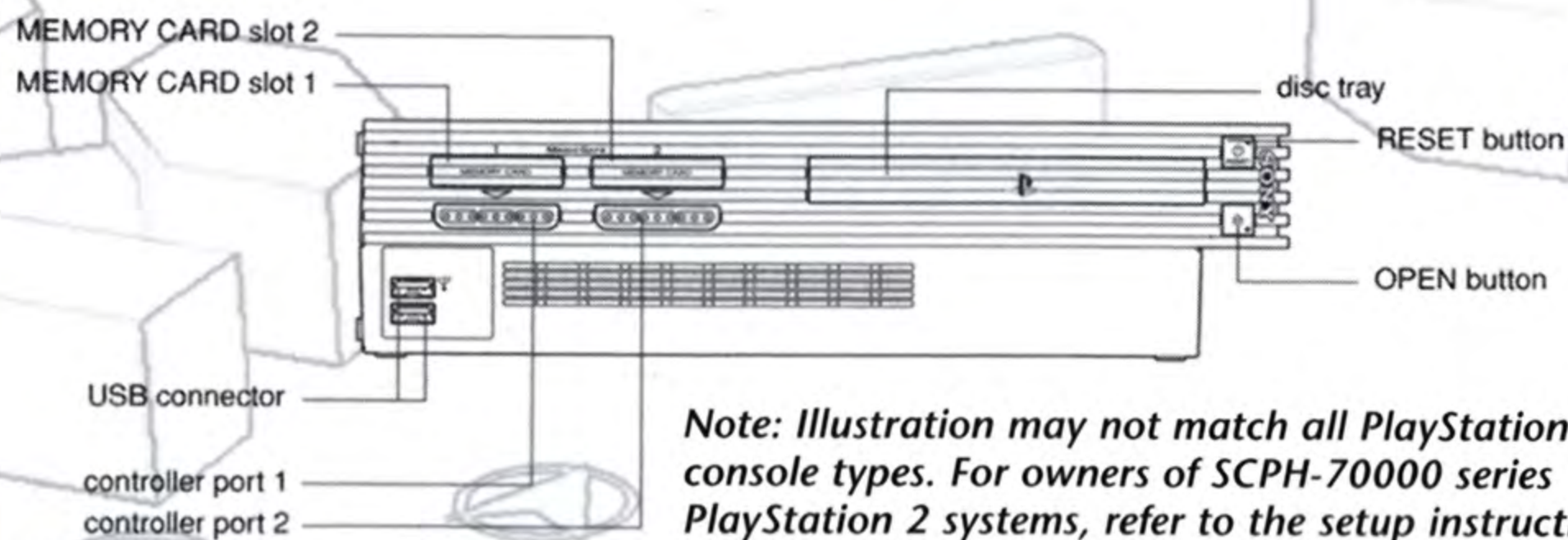

Note: Illustration may not match all PlayStation 2 console types. For owners of SCPH-70000 series PlayStation 2 systems, refer to the setup instructions supplied with your system.

Set up your PlayStation®2 computer entertainment system according to the instructions in its Instruction Manual. Make sure the *MAIN POWER* switch (located on the back of the console) is turned ON.

Press the *RESET* button. When the power indicator lights up, press the *OPEN* button and the disc tray will open. Place the *FLIPNIC™* disc on the disc tray with the label side facing up. Press the *OPEN* button again and the disc tray will close.

Attach game controllers and other peripherals, as appropriate. Follow on-screen instructions and refer to this manual for information on using the software.

Memory Card (8MB)(for PlayStation®2)

To save game settings and progress, insert a memory card (8MB)(for PlayStation®2) into MEMORY CARD slot 1 of your console. You can load saved game data from the same memory card or from any memory card containing previously saved games.

- ⚡ You must be using a memory card with at least 30KB of free space in order to save your game data. If you need more free space than is available, delete older data from the memory card before starting play.**
- ⚡ Do not remove the memory card or turn off the power while saving or loading game data. Doing so could damage your game data.**

controller

DUALSHOCK[®]2 analog controller configurations

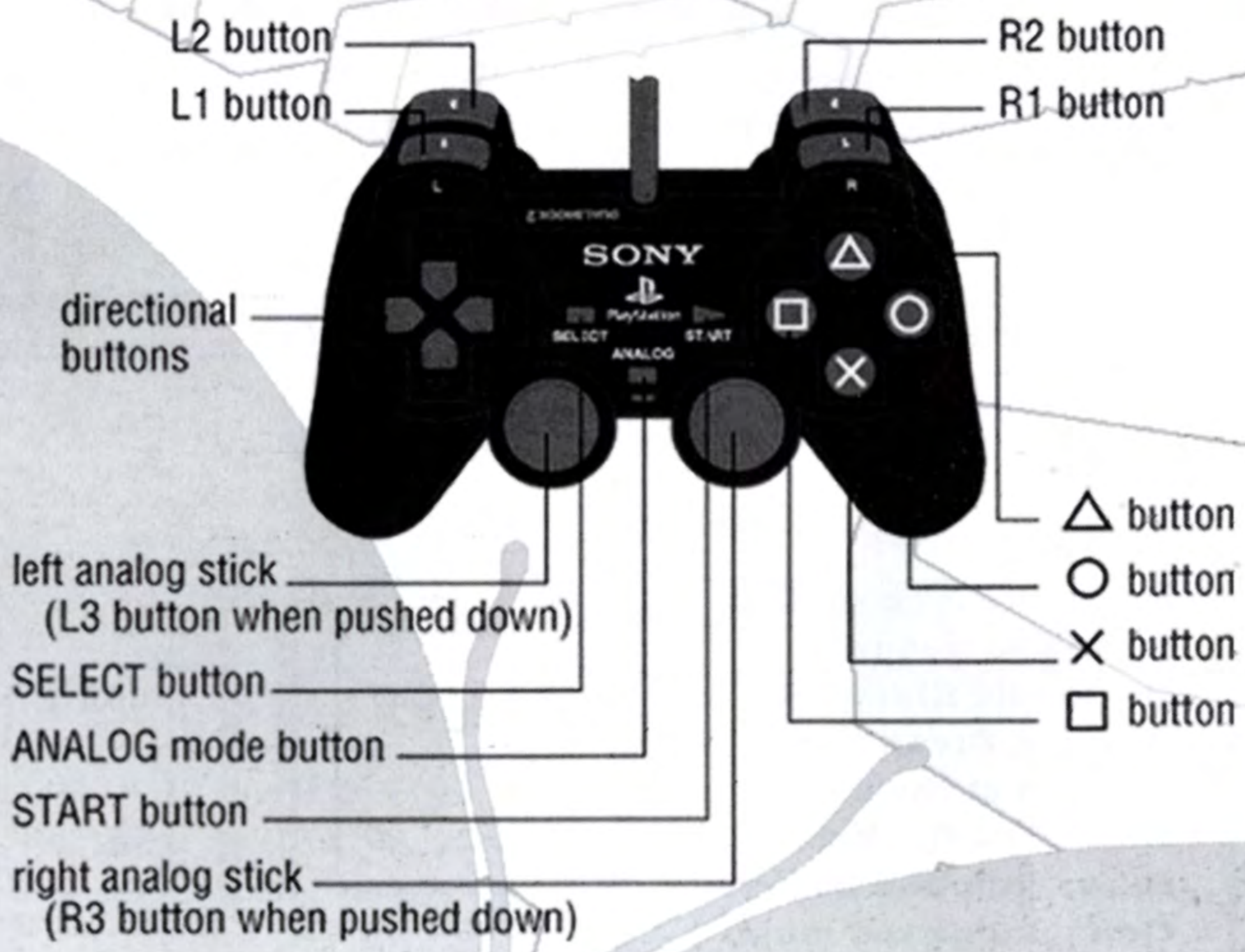

Before starting play, connect the DUALSHOCK[®]2 analog controller to controller port 1. For two-player games, connect a second controller to controller port 2. You can turn the controller's vibration function on/off in Option Mode (see page 10).

menu controls

- left analog stick ↑ / ↓ ... select menu option
- left analog stick ← / → ... change option setting
- directional buttons same as left analog stick
- ⊗ button confirm
- △ button cancel

default game controls

left flipper & bumpers

Press the ← directional button to flip all the left-side flippers and move all the movable bumpers on screen.

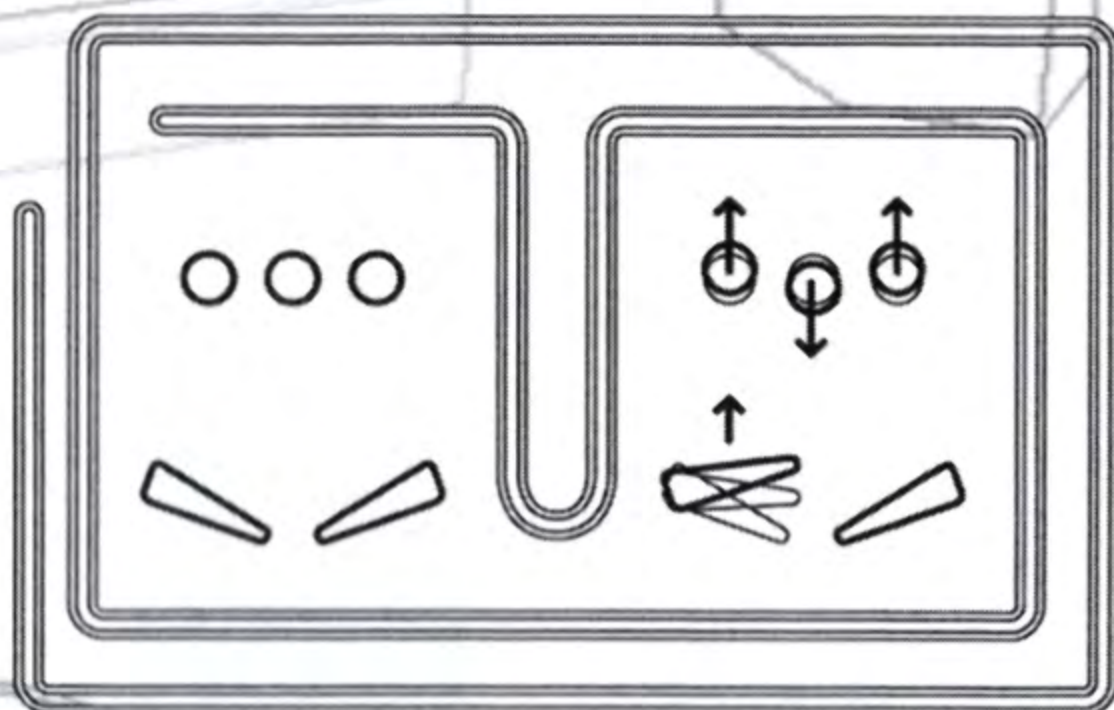

nudge

Press the **L1** or **R1** button to nudge the whole Stage left or right. Press both buttons at the same time to nudge the Stage from the bottom. Don't nudge too much or you'll "tilt" and lose a turn.

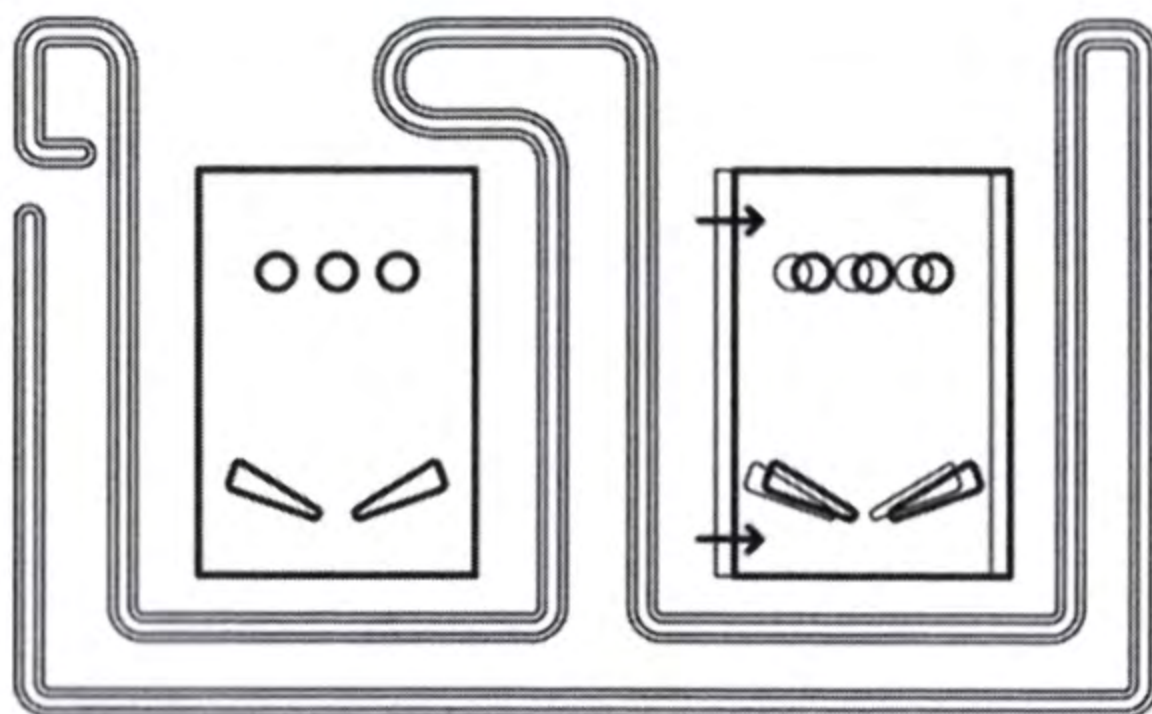

stage screen

Press the **SELECT** button to pause the game and view the Stage Status screen.



launch the ball

When you see a red light circling the ball, press the  button to stop the light and launch the ball in that direction.

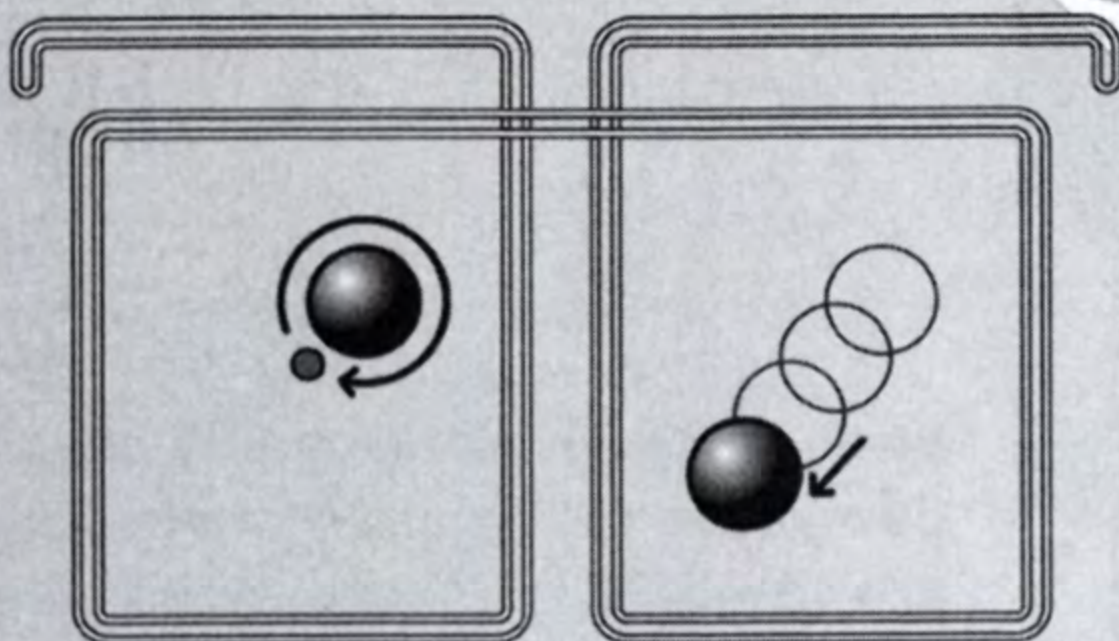

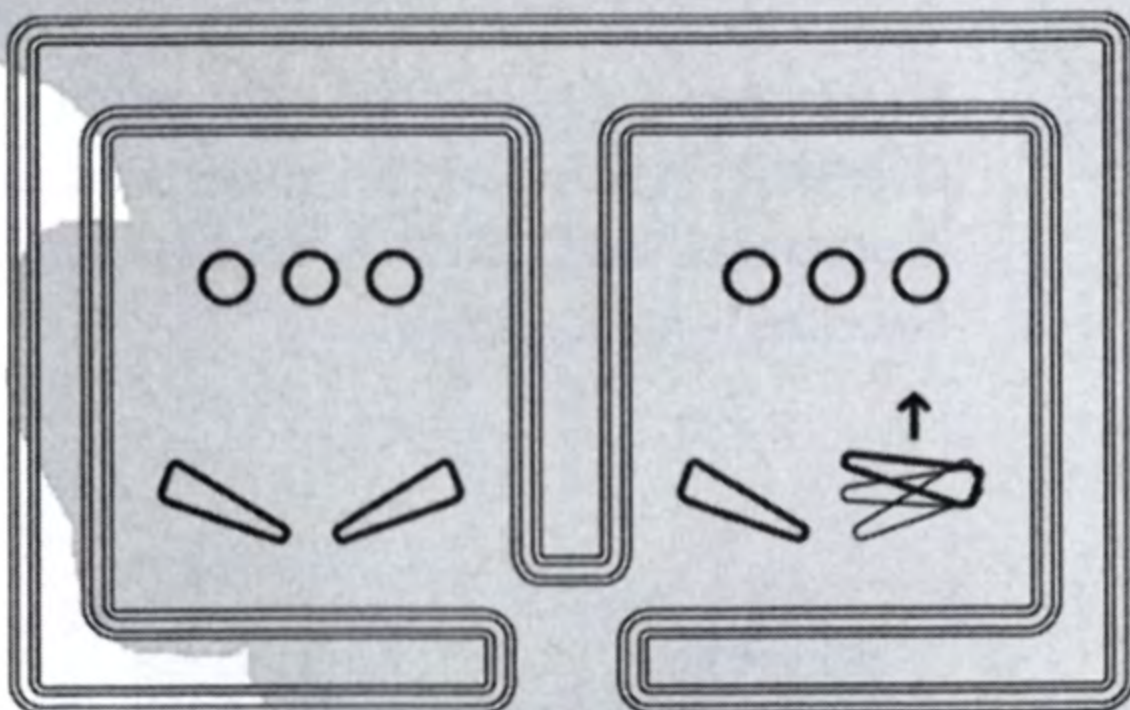

right flipper

Press the  button to flip all the right-side flippers. Doing this does not move the bumpers.



BACK or GO

When the ball enters certain paths, it stops and you have the option to press the  button to go forward, or press the  directional button to go backward.

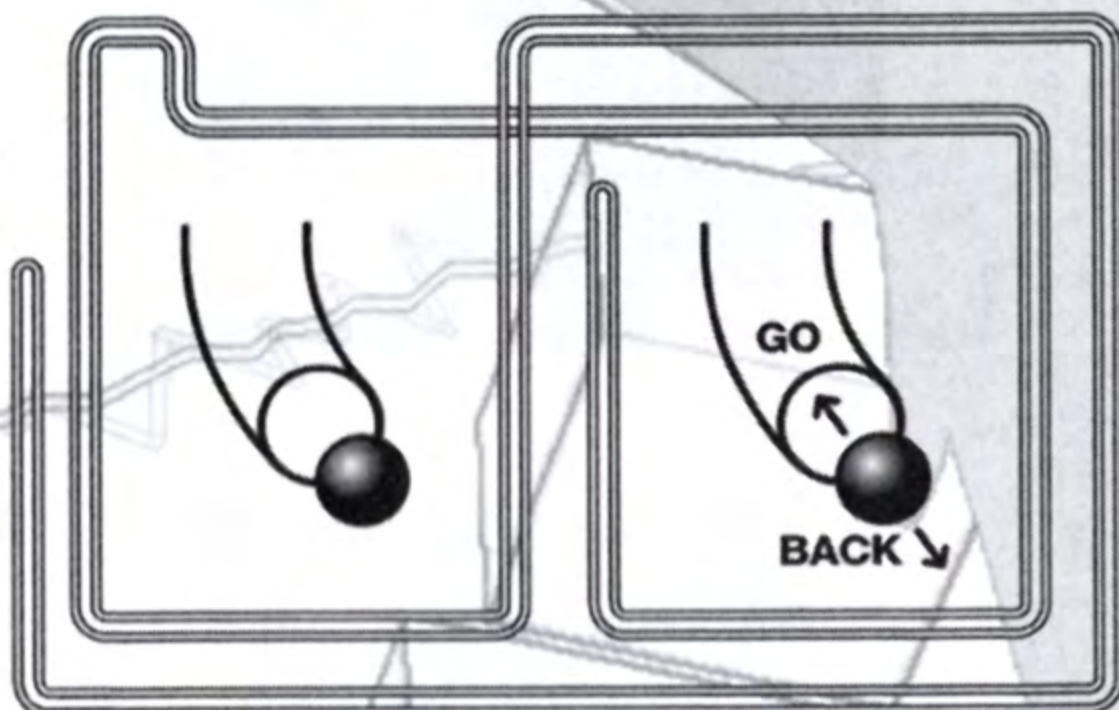

pause

Press the  **START** button to pause the game and view the Pause menu. (See page 12.)

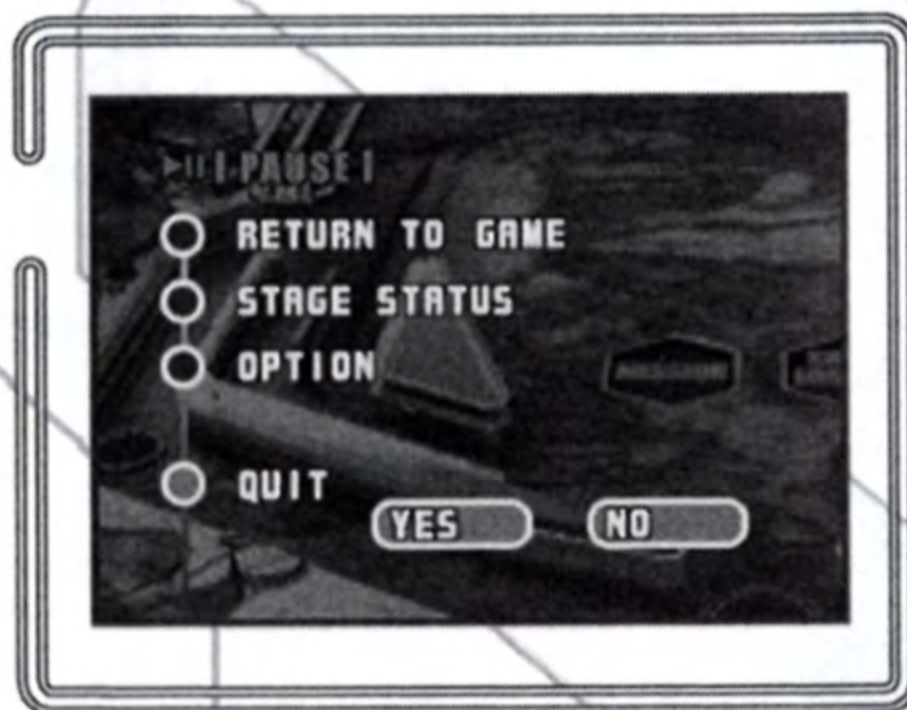

rules

goals

Each Stage has different areas and missions you must complete in order to move on to the next Stage. Once you are familiar with the Stage layout, hone your skills and try for high score records!

missions

Each Stage has two types of objectives or missions. **RED MISSIONS** must be completed in order to beat the Stage. Optional **YELLOW MISSIONS** are not required to advance through the game.



red missions

You finish a Stage by clearing all the Red Missions. The Stage maps on pages 14-21 have information on where the Red Missions are located. Check the Stage Status screen to see the rules for a particular mission.

yellow missions

If you want to go for high scores, Yellow Missions offer plenty of opportunity for racking up the points with multi-ball play, mini-games, etc. Completing Yellow Missions won't get you through a Stage any faster, but they are absolutely essential when you are trying for a high score.



completing stages

Beat all the Red Missions in a Stage to complete that Stage. The more Stages you complete, the more new ones become available to play and enjoy.



miss

If your ball goes where there is no lane or surface, it falls and you lose a turn. There are signs where the ball can fall through, so use your bumpers and nudging to avoid losing a turn.

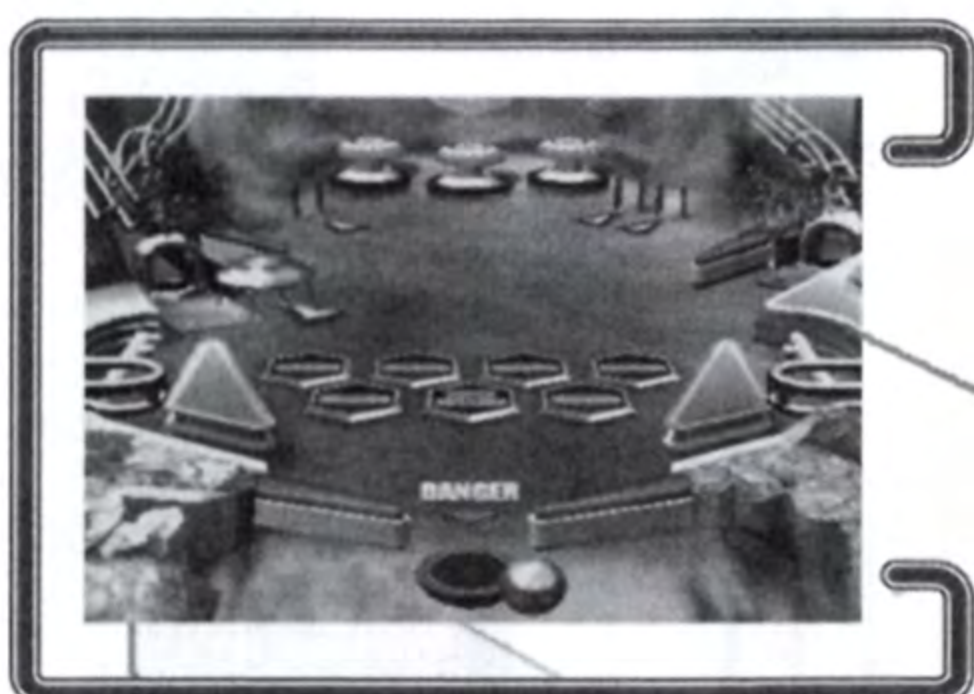

continue

When you lose all your balls, if you have any credits left, you can use a credit and continue your game where you left off.

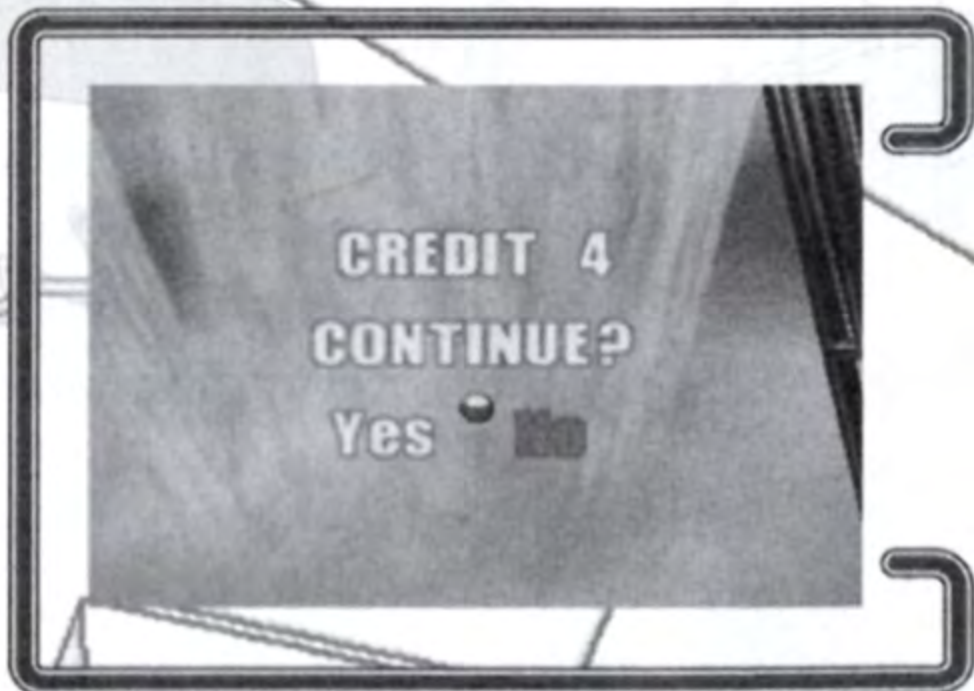

game over

If you don't have any credits left when you lose all your balls, or if you have credits remaining but don't select *CONTINUE*, your game will be over. To play again, you will have to start over from the beginning, with all Stages returned to their initial status.



gimmicks



bumpers

When the ball hits a bumper, it bounces off and you get points. Some bumpers can be moved up and down on the screen with the ← directional button. Move the bumpers around to guide the ball where you want it to go.

ball save bumpers

When you do certain things in the game, special blue bumpers appear in places where the ball can fall off the edge. These bumpers disappear once the ball hits them. You can change the status of multiple Ball Save Bumpers with the flipper controls.

counters

- 🌀 **EXP** – Experience points. Gain more points by doing different things in the game.
- 🌀 **LANES** – Number of times the ball has gone through lanes.
- 🌀 **BUMPERS** – Number of times the ball has hit bumpers.
- 🌀 **COINS** – Number of coins collected. The total number of coins for your current game appears over the total number of coins for the ball in play.



coins

Run over coins with the ball to collect them. Running into them does not change the path of the ball. Press the **○** button to make the ball jump to get coins floating in the air above lanes.

lanes

Lanes are special paths that take the ball to different areas. Some lanes have a **GO/BACK** option to either go up the ramp or send the ball back. To select **GO**, press the **○** button. Press the **←** directional button to select **BACK** and skip going up the lane. While on lanes, press the **○** button to make the ball jump in the air.

free extra try

If you collect enough coins, a **BLUE UFO** appears. Before the UFO disappears, hit it with the ball to get a free extra try the next time your ball falls off the edge.



extra credit

If you collect enough coins, a **YELLOW UFO** appears. Hit the yellow UFO with the ball before it disappears to get an extra credit for an extra continue.



multi-ball & jackpot

Completing certain missions will bring another ball to the Stage, so you can play with two at the same time. During this time, if you send the ball through the lane with the **YELLOW ARROW**, you can collect the Jackpot and rack up a bunch of extra points.

- 🌀 The size of the Jackpot is determined by the number of coins you have collected up to then, so the more coins you have when multi-ball play starts, the bigger the Jackpot will be.
- 🌀 Collect all the Jackpots during one multi-ball play and you can get the Super Jackpot for a huge amount of extra points.
- 🌀 If you lose one of the balls, the game reverts to normal.



menus

main menu

- ↻ **ORIGINAL GAME** – Play the original single-player **FLIPNIC!**
See page 11.
- ↻ **FREE PLAY & 2P MATCH** – Play single- or two-player matches designed especially for the PlayStation 2 video game system.
- ↻ **MEMORY CARD** – Save/load game data to a memory card inserted in MEMORY CARD slot 1. The first time you save you will need at least 30KB of free space.
- ↻ **HELP** – View movie(s) that explain the rules and techniques for the game to get a grasp of how things work.
- ↻ **OPTION** – Adjust game settings. See **OPTION** below.
- ↻ **STAFF** – View the staff credits.
- ↻ **EXTRA** – Modify additional game settings.
See **EXTRA** below.

option

- ↻ **SOUND/BGM/SE** – Use the menu controls (see page 3) to change the audio setting and adjust the volume of the music and sound effects in the game.
- ↻ **VIBRATION** – Turn the controller's vibration function on/off.

extra

- ↻ **BUTTON CONFIGURATION** – Change the game controls.
- ↻ **RANKING** – View high scores for each Stage.
- ↻ **RETRY** – Restore the Original Game Stage Clear status to its default.

original game

This is the main single-player mode. Start on the first available Stage and play through the Stages to unlock new ones.

Sample Stages 3 and 5, with a time limit, to get a taste of what's to come once you unlock them!

stage select

Select *ORIGINAL GAME* from the Main Menu to move to the Stage Select screen. You can play the Stages in *GREEN* text with no time limits. Play the Stages in *YELLOW* text with a time limit. Complete the available Stages to unlock new ones for play.

stage menu

Select *GAME START* to start playing the Stage. You can also select either the *EASY*, *NORMAL* or *HARD* difficulty level. Select *STAGE STATUS* to view the status of that Stage.

1p play

Play Stages alone from Original Game Free Play mode (see page 12) or 2P Match Free Play (see page 13). Playing in Free Play mode does not affect the Stage Status screen results.



free play & 2p match

stage select

This mode is slightly different from the Original Game, with separate rankings as well.

stage menu

Select **GAME START** to start playing the Stage. Before the Stage begins, you can select either **SCORE ATTACK** or **TIME ATTACK** mode, each with its own score ranking.







2p play

Selecting this takes you into the Stage. Press the  button to begin.

To play a 2P Stage, insert two controllers into controller ports 1 and 2. The controller in port 1 is Player 1 (red), and the controller in port 2 is Player 2 (blue).

pause menu

Press the  **START** button to pause the game and bring up the Pause Menu. Use the menu controls (see page 3) to select from these options:

-  **RETURN TO GAME** – Close the Pause Menu and return to your game.
-  **STAGE STATUS** – Display a list of the names of all the missions for the current Stage, their triggers and whether or not they have been completed. Turn pages with the  directional buttons, and scroll up and down the pages with the  directional buttons. Press the  button to see a description of mission hints on how to complete the Stage.
Note: This option is not available in two-player mode (2P Play).
-  **OPTION** – Change various game settings. See page 10.
-  **QUIT** – End your game and return to the Stage Select screen.



2P match

BIOLOGY (foosball striker)

Use the **○** button to make your bumpers go up and down to try to get the ball into your opponent's goal. Get five points within five minutes to win. If time runs out, the player with the most points wins.

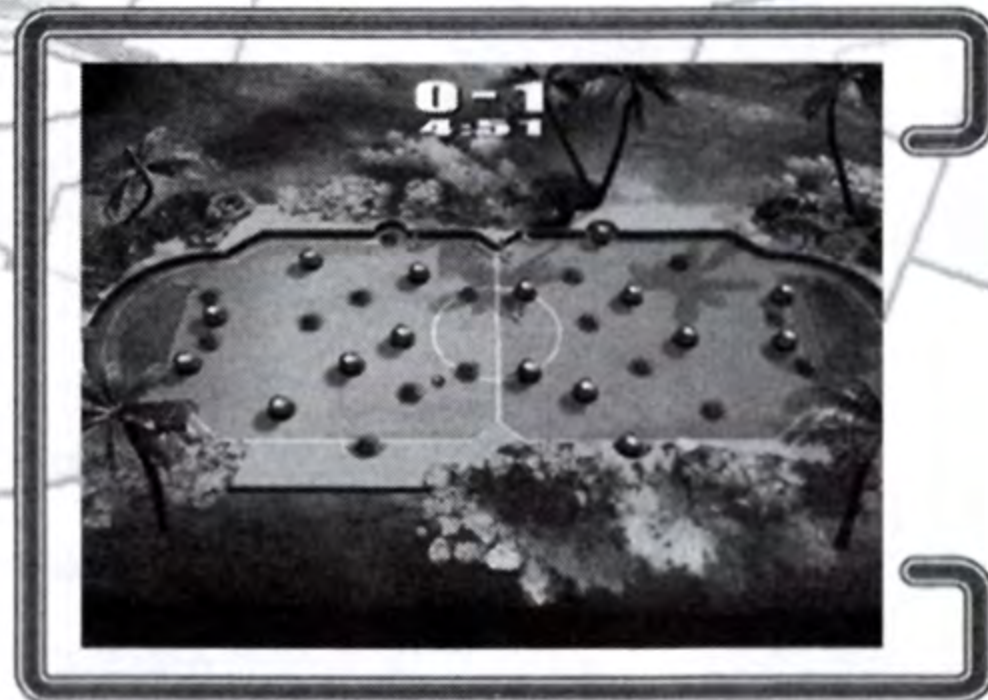

METALLURGY (basketball 1-on-1)

Try to get as many balls in your goal as possible. Use the **←** directional button for the left flipper, and the **○** button for the right flipper and bumpers. Get 10 points within three minutes to win. If time runs out, the player with the most points wins.

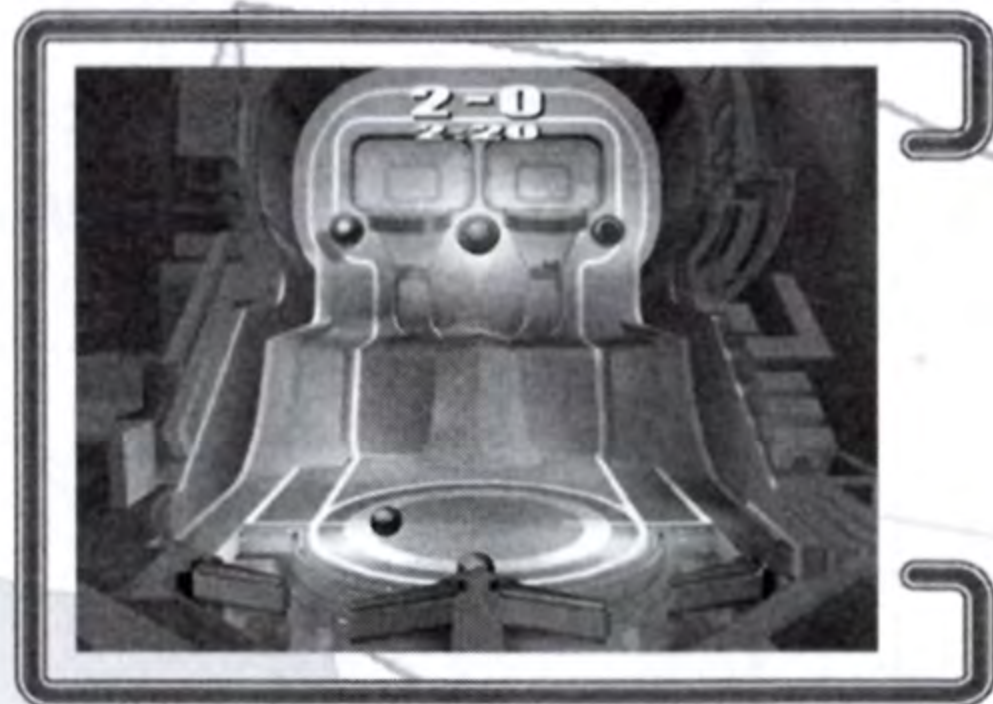

OPTICS (vs. bagatelle)

Use the **○** button to control the flippers and bumpers in order to get the ball into your opponent's goal. Get 10 points within three minutes to win. If time runs out, the player with the most points wins.

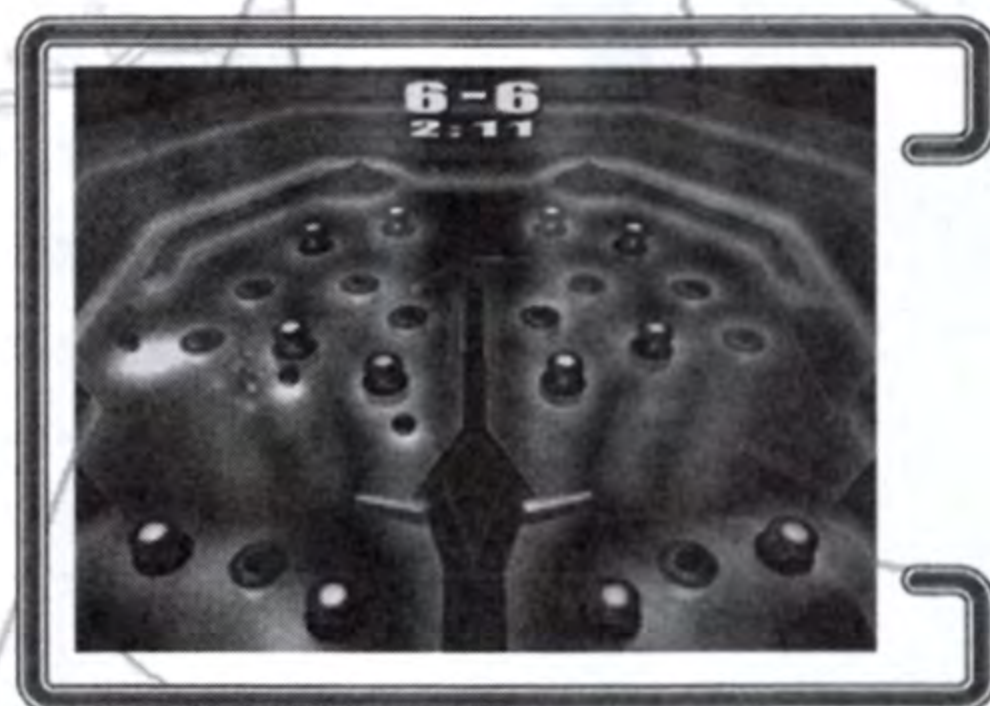

GEOMETRY (triple paddle)

Press **↑ / ↓** on the directional buttons or left analog stick to move your paddle up and down. Hit the ball with your paddle to bounce it off and into your opponent's goal. There is no time limit, and the first player to get 10 points wins.

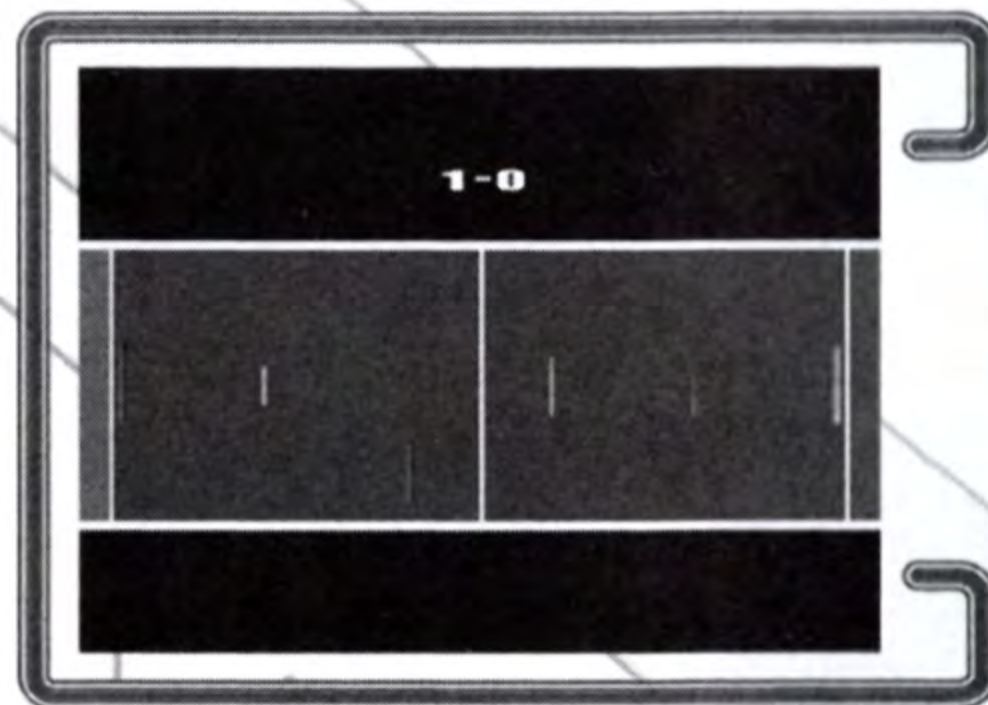

biology

1 *Bumper Village*
Perfect Bumper Village

2 *Lucky Flamingos*
Hungry Monkey
Color Puzzle
Money Money Money
UFO Quiz Show
Lane Count Mission 1
Hidden Path Discovery

3 *Freeze Over*

4 *Circle of Life*
Multi Ball 1
Multi Ball 2
Lane Count Mission 2
Lane Count Mission 3

5 *Zero Gravity*

START

1

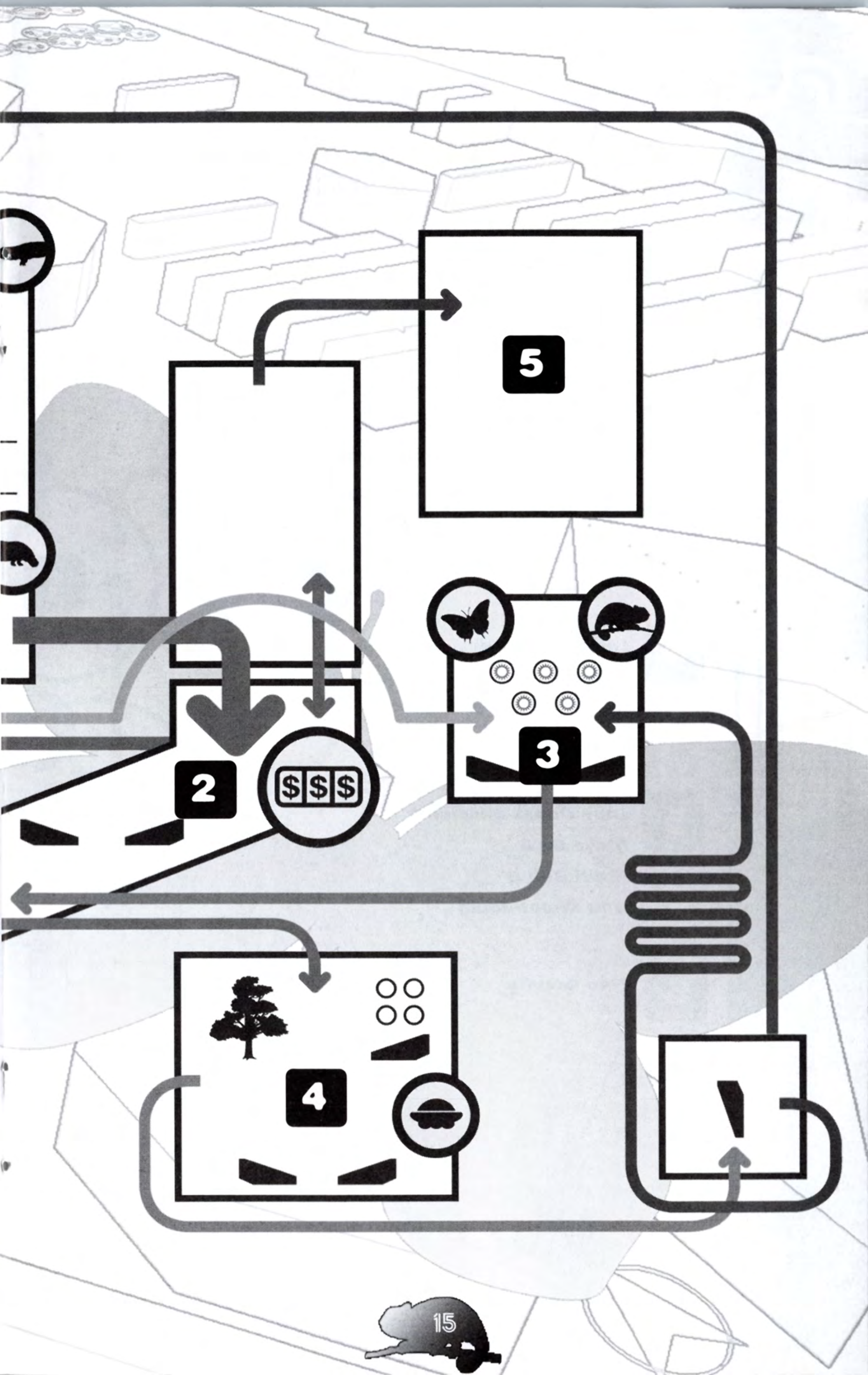

metallurgy

1 *Multi Ball 3*
Crab Baby Shoot-down
Spidercrab Shoot-down

2 *Stop the Four Shafts 1*

3 *Stop the Four Shafts 2*

4 *Lane Count Mission 1*
Move On 1
Multi Ball 1
UFO Shoot-down

5 *Lane Count Mission 2*
Move On 2
Multi Ball 2
UFO Shoot-down

6 *Zero Gravity*

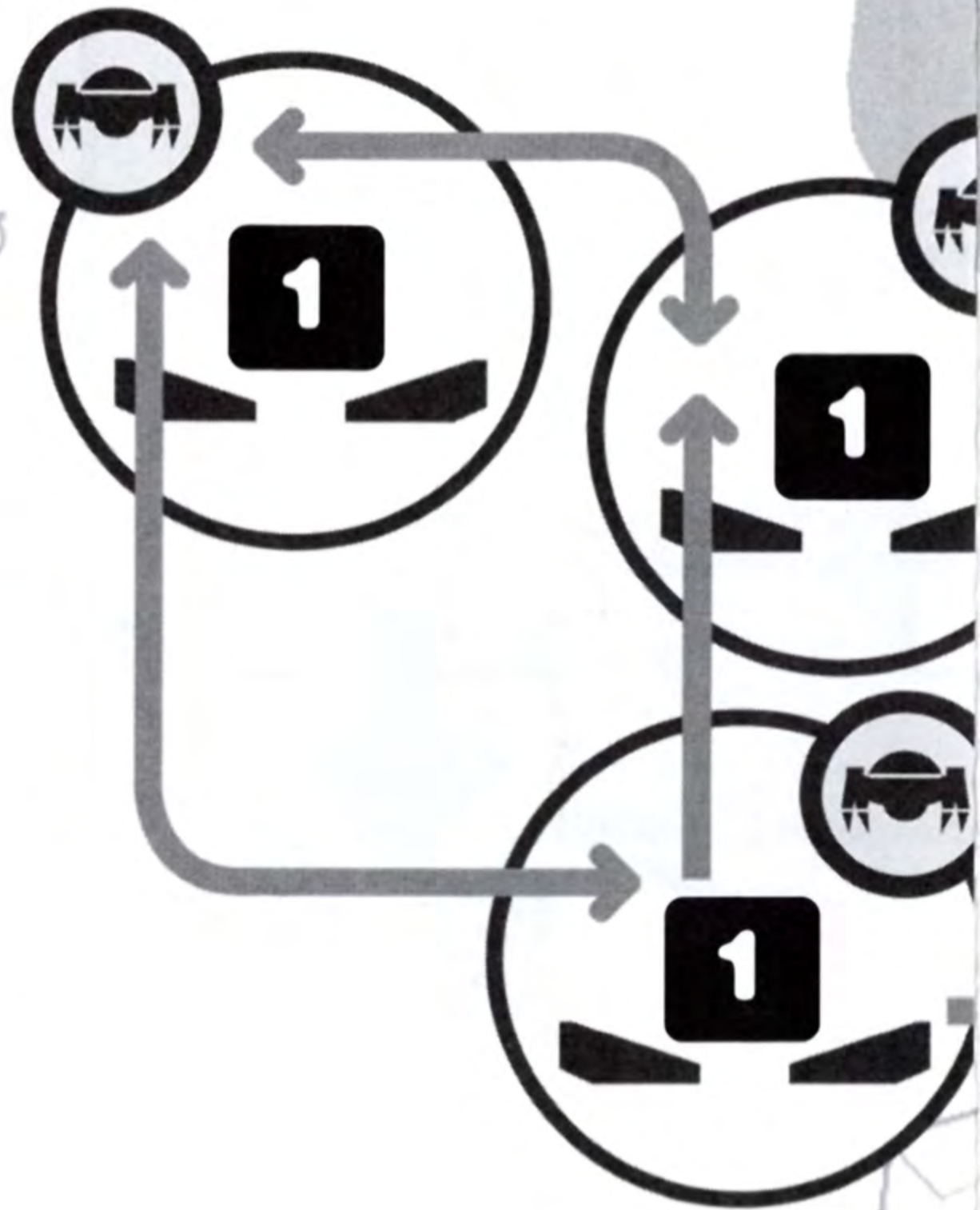

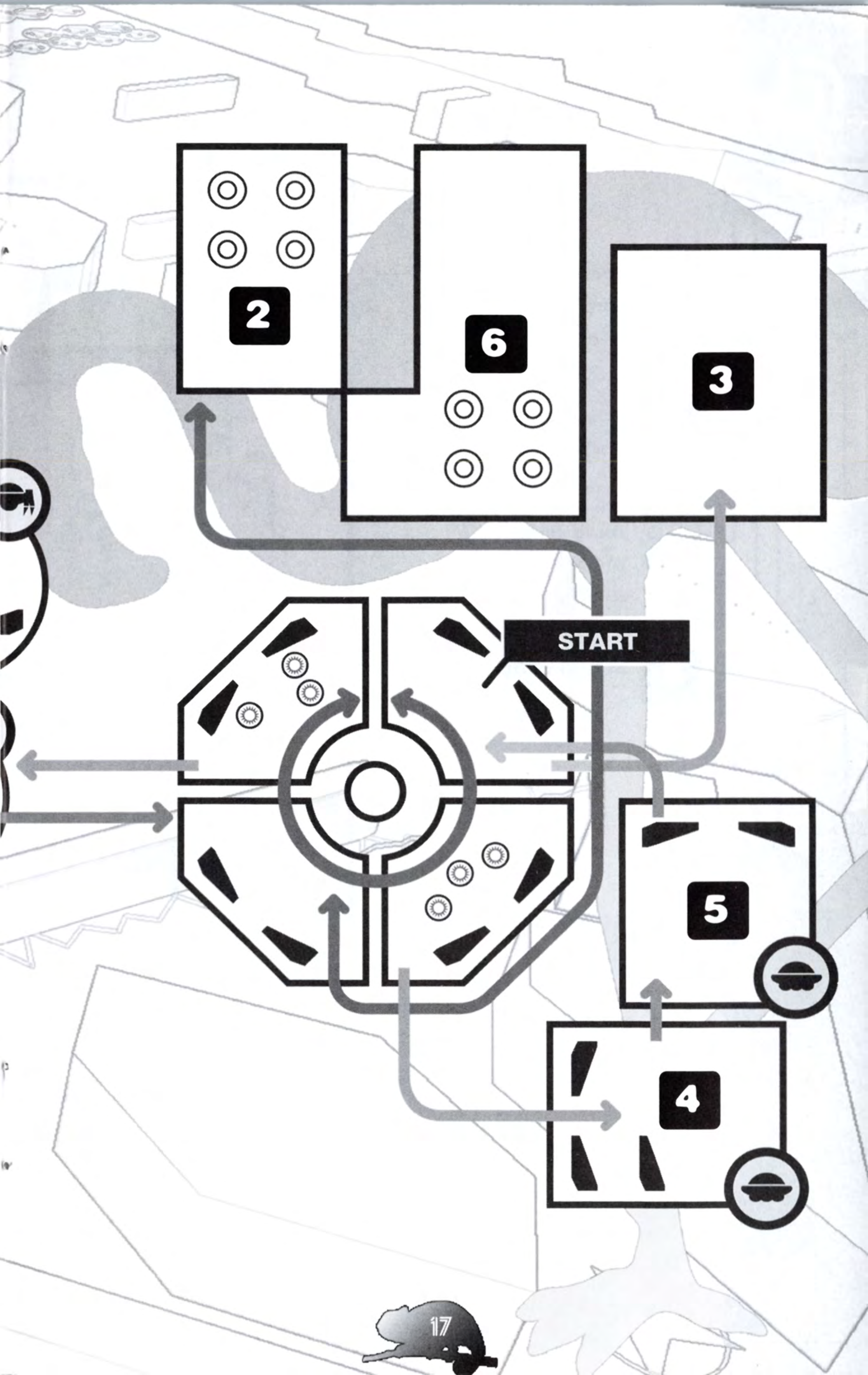

2

6

3

START

5

4

optics

1 *Loop the Loop 1*
Loop the Loop 2
Loop the Loop 3

2 *Bumper Village*
Perfect Bumper Village

3 *Multi Ball 1*
Multi Ball 2
Multi Ball 3

4 *Zero Gravity*

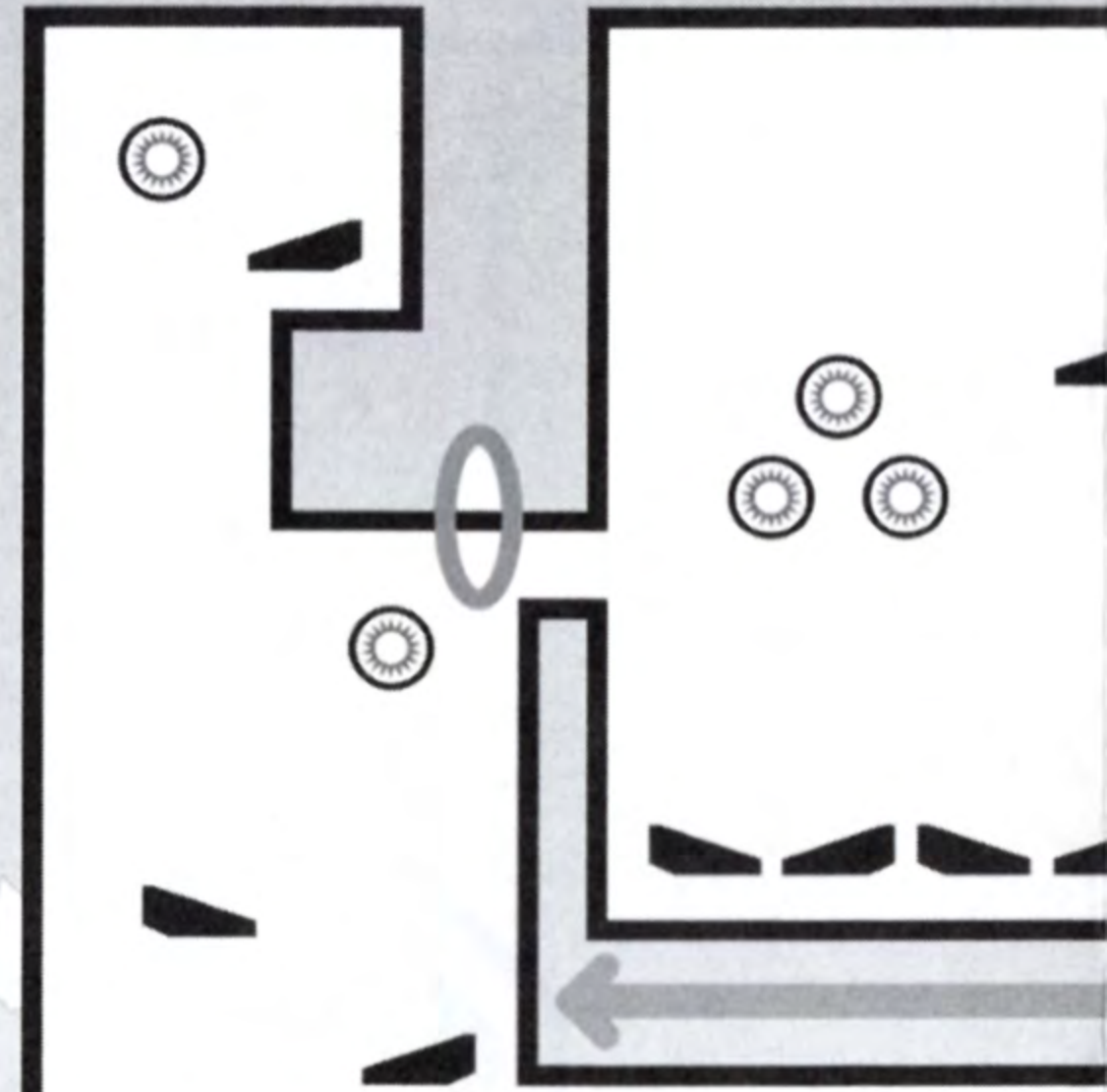

NON STOP AREA





START

BUMPER AREA

1

3

2

geom@try

1

Area 74

2

Galaxy Tennis

3

Alien Hill

4

ChuChu Multi Ball

5

Extra Ball
Extra Credit

START

3



notes

Hand-drawn sketches of 3D rectangular blocks and circular objects with internal lines, scattered across the page. The page is ruled with horizontal lines for writing notes.

CREDITS

Manual: Hanshaw Ink & Image; Marketing: Todd Thorson, David Riley, Jack Symon, Sarah Felbinger, Laili Bosma, Carrie Root, Robert Johnson, Nate Williams, Rey Jimenez and Ryuhei Tanabe; Package Design: Michi Morita, Corey Tran and Scott Baumann; Translation: Thomas Huston and Brian Dunn; PR: Melinda Mongelluzzo, Arne Cual and Alicia Kim; Customer Service: Philip Navidad, Robert Hamiter and Frank Filice.

90-DAY LIMITED WARRANTY

CAPCOM ENTERTAINMENT, INC. ("CAPCOM") warrants to the original consumer that this DVD-ROM from CAPCOM shall be free from defects in material and workmanship for a period of 90 days from date of purchase. If a defect covered by this warranty occurs during this 90-day warranty period, CAPCOM will replace the DVD-ROM free of charge.

To receive this warranty service:

1. Notify the CAPCOM Consumer Service Department of the problem requiring warranty service by calling (408) 774-0400. Our Consumer Service Department is in operation from 8:30 a.m. to 5:00 p.m. Pacific Time, Monday through Friday.
2. If the CAPCOM service technician is unable to solve the problem by phone, he/she will instruct you to return the entire DVD-ROM to CAPCOM freight prepaid at your own risk of damage or delivery. We recommend sending your DVD-ROM certified mail. Please include your sales slip or similar proof of purchase within the 90-day warranty period to:

CAPCOM
Consumer Service Department
475 Oakmead Parkway
Sunnyvale, CA 94085

This warranty shall not apply if the DVD-ROM has been damaged by negligence, accident, unreasonable use, modification, tampering or by other causes unrelated to defective materials or workmanship.

REPAIRS AFTER EXPIRATION OF WARRANTY

If the DVD-ROM develops a problem after the 90-day warranty period, you may contact the CAPCOM Consumer Service Department at the phone number noted previously. If the CAPCOM service technician is unable to solve the problem by phone, he/she may instruct you to return the defective DVD-ROM to CAPCOM freight prepaid at your own risk of damage or delivery, enclosing a check or money order for \$20.00 (U.S. funds only) payable to CAPCOM. We recommend sending your DVD-ROM certified mail. CAPCOM will replace the DVD-ROM, subject to the conditions above. If replacement DVD-ROMs are not available, the defective product will be returned to you and the \$20.00 payment refunded.

WARRANTY LIMITATIONS ANY EXPRESS OR IMPLIED WARRANTIES, INCLUDING WARRANTIES OF MERCHANTABILITY AND FITNESS FOR A PARTICULAR PURPOSE, ARE HEREBY DISCLAIMED. IN NO EVENT SHALL CAPCOM BE LIABLE FOR SPECIAL, INDIRECT, CONSEQUENTIAL OR INCIDENTAL DAMAGES RESULTING FROM THE BREACH OF ANY EXPRESS OR IMPLIED WARRANTIES.

The provisions of this warranty are valid in the United States and Canada only. Some states and provinces do not allow limitations on how long an implied warranty lasts or exclusions of consequential or incidental damages, so the above limitations and exclusions may not apply to you. This warranty gives you specific legal rights, and you may have other rights, which vary from state to state or province to province.

ESRB RATING

This product has been rated by the Entertainment Software Rating Board. For information about the ESRB rating, or to comment about the appropriateness of the rating, please contact the ESRB at www.esrb.org.



CAPCOM

www.capcom.com