

# MX Superfly

FEATURING  
**RICKY CARMICHAEL**

**IN STORES  
NOW**

[www.mxsuperfly.com](http://www.mxsuperfly.com)



**THQ**  
[www.thq.com](http://www.thq.com)

THQ Inc., 27001 Agoura Rd., Suite 270, Calabasas Hills, CA 91301

Instruction Manual © 2003 THQ Inc. MotoGP™ 2 and © 2003 Dorna Sports, S.L. MotoGP and related logos, characters, names, and distinctive likenesses thereof are the exclusive property of Dorna Sports, S.L. and/or their respective owners. Used under license. All Rights Reserved. Developed by Climax Studios Ltd. Climax Studios Ltd. and its logo are trademarks and/or registered trademarks of Climax Studios Ltd. MX Superfly © 2002 THQ Inc. Ricky Carmichael used under exclusive license by THQ Inc. THQ, the THQ logo and the MX Superfly logo are trademarks and/or registered of THQ Inc. All Rights Reserved. All other trademarks, logos and copyrights are property of their respective owners. Microsoft, Xbox, Xbox Live and the Xbox Logos are either registered trademarks or trademarks of Microsoft Corporation in the U.S. and/or other countries and are used under license from Microsoft.

EVERYONE  
**E**  
CONTENT RATED BY  
ESRB

Mild Lyrics

**XBOX**

LIVE ONLINE ENABLED

PO-MOTO GP 2 XB



2336253

# **motogp 2**

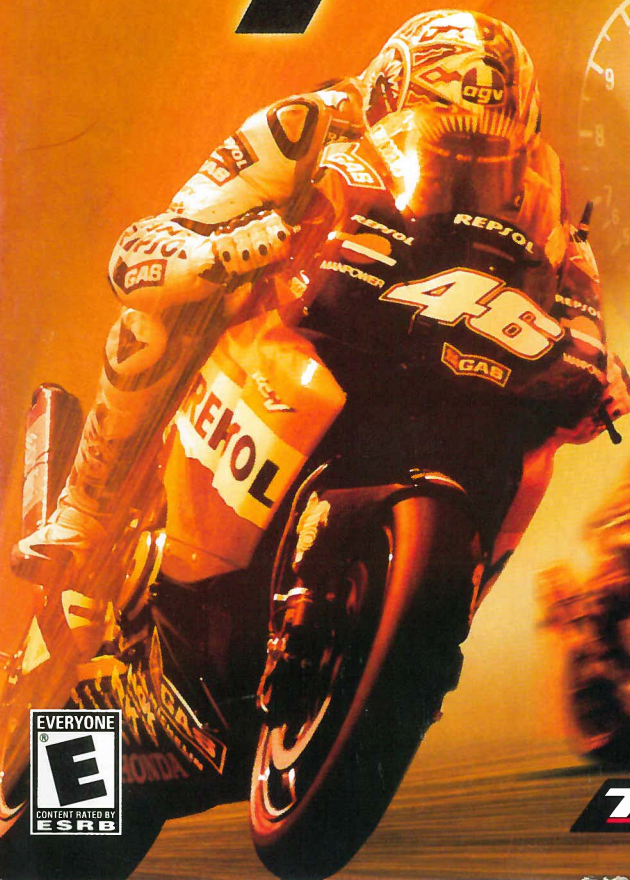

EVERYONE  
**E**  
CONTENT RATED BY  
ESRB

**THQ**



## Safety Information

### About Photosensitive Seizures

A very small percentage of people may experience a seizure when exposed to certain visual images, including flashing lights or patterns that may appear in video games. Even people who have no history of seizures or epilepsy may have an undiagnosed condition that can cause these photosensitive epileptic seizures while watching video games.

These seizures may have a variety of symptoms, including lightheadedness, altered vision, eye or face twitching, jerking or shaking of arms or legs, disorientation, confusion, or momentary loss of awareness. Seizures may also cause loss of consciousness or convulsions that can lead to injury from falling down or striking nearby objects.

Immediately stop playing and consult a doctor if you experience any of these symptoms. Parents should watch for or ask their children about the above symptoms — children and teenagers are more likely than adults to experience these seizures.

The risk of photosensitive epileptic seizures may be reduced by sitting farther from the television screen, using a smaller television screen, playing in a well-lit room, and not playing when you are drowsy or fatigued.

If you or any of your relatives have a history of seizures or epilepsy, consult a doctor before playing.

**Other Important Health and Safety Information** The Xbox Instruction Manual contains important health and safety information that you should read and understand before using this software.

### Avoid Damage to Your Television

**Do not use with certain televisions.** Some televisions, especially front- or rear-projection types, can be damaged if any video games, including Xbox games, are played on them. Static images presented during the normal course of game play may “burn in” to the screen, causing a permanent shadow of the static image to appear at all times, even when video games are not being played. Similar damage may occur from static images created when placing a video game on hold or pause. Consult your television owner’s manual to determine if video games can be played safely on your set. If you are unable to find this information in the owner’s manual, contact your television dealer or the manufacturer to determine if video games can be played safely on your set.

Unauthorized copying, reverse engineering, transmission, public performance, rental, pay for play, or circumvention of copy protection is strictly prohibited.

## Table of Contents

Connect to Xbox Live™	2
Using the Xbox Video Game System	4
Using the Xbox Controller	5
MotoGP 2 Standard Controls	6
Introduction	7
The Race Screens	7
Getting Started	9
The Game Menu Screen	9
Quick Race	9
Career Mode	13
Stunt Mode	20
Time Trial	21
Multiplayer Races	22
Replay Cameras	31
Settings Menu	33
In-Game Options	35
Stunts and Special Maneuvers	35
Credits	37
Warranty	40





## Connect to Xbox Live

**Important!** Before using this product, read the Xbox Instruction Manual for important safety information and health warnings.

### Step 1: Connect

To connect your Xbox console directly to broadband, see diagram A. Or, to share your broadband connection with a PC, see diagram B.

For more details and other home networking options, including Internet connection sharing, see [www.xbox.com/live](http://www.xbox.com/live).

#### A. Direct Connection

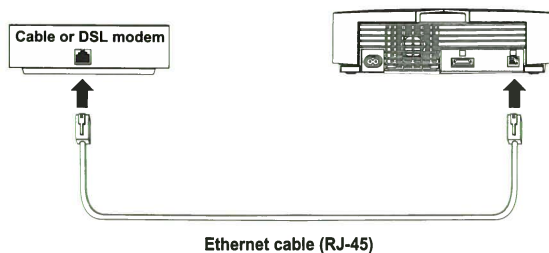

#### B. Shared Connection

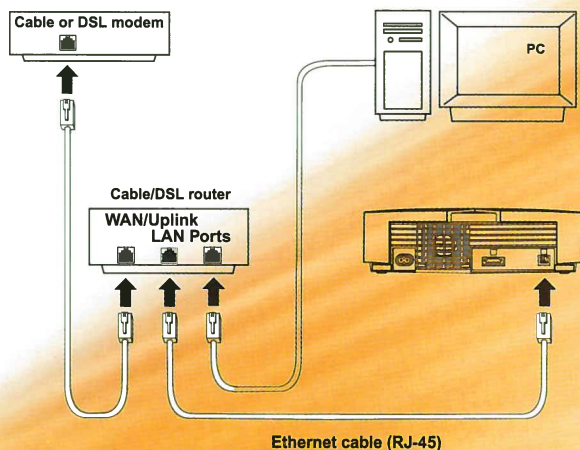

### Step 2: Go Live

**Important!** Xbox Live™ is a subscription service. You will need a subscription code to set up an Xbox Live account and play online. To find out how to get a subscription code, visit your local retailer or see [www.xbox.com/live](http://www.xbox.com/live).

You'll need to set up an Xbox Live account to play games online. Here's how:

1. Insert an Xbox Live Starter Kit disc or game disc into the disc tray. Check game packaging to see if the game supports Xbox Live play.
2. From within the game, select the option for Xbox Live.

At this point, the Xbox console will try to go online. If it works, create your Xbox Live account by following the instructions on screen and entering your subscription code when prompted.

If the Xbox console can't go online automatically, you'll get an error message. Go on to Step 3.

### Step 3: Configure (if necessary)

If you can't go online automatically, use Network Setup in the Xbox Dashboard to enter some network settings. You may need to enter information such as a host name, a MAC address, or an ISP user name and password. Contact your broadband service provider if you don't have this information. Once you have the information, enter it in the Xbox Dashboard.

#### Need more help?

Should you have any problems connecting to the Xbox Live service, do not attempt to take apart, service, or modify the Xbox console or peripherals in any way. Doing so could present the risk of serious injury or death from electric shock or fire and will also void your warranty. For additional assistance see [www.xbox.com/live](http://www.xbox.com/live) or call the Customer Support number:

- United States and Canada: 1-800-4MY-XBOX (1-800-469-9269)
- TTY users (requires special equipment for hard of hearing):  
United States and Canada: 1-866-740-9269 or 1-425-635-7102



## Using the Xbox Video Game System

1. Set up your Xbox video game system by following the instructions in the Xbox Instruction Manual.
2. Press the power button and the status indicator light will light up.
3. Press the eject button and the disc tray will open.
4. Place the **MotoGP 2** disc on the disc tray with the label facing up and close the disc tray.
5. Follow all on-screen instructions and refer to this manual for more information about playing **MotoGP 2**.

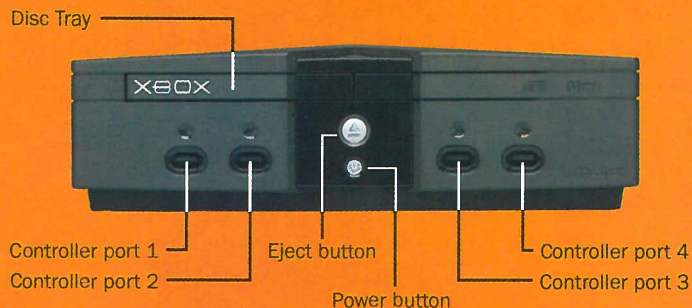

### Avoiding Damage to Discs or the Disc Drive

To avoid damage to discs or the disc drive:

- Insert only Xbox-compatible discs into the disc drive.
- Never use oddly shaped discs, such as star-shaped or heart-shaped discs.
- Do not leave a disc in the Xbox console for extended periods when not in use.
- Do not move the Xbox console while the power is on and a disc is inserted.
- Do not apply labels, stickers, or other foreign objects to discs.

## Using the Xbox Controller

1. Insert the Xbox Controller into any controller port on the Xbox console. For multiple players, insert any additional controllers.
2. Insert any peripherals (for example, Xbox Memory Units) into the Controller expansion slots as appropriate.
3. Follow all on-screen instructions and refer to this manual for more information about using the Xbox Controller to play **MotoGP 2**.

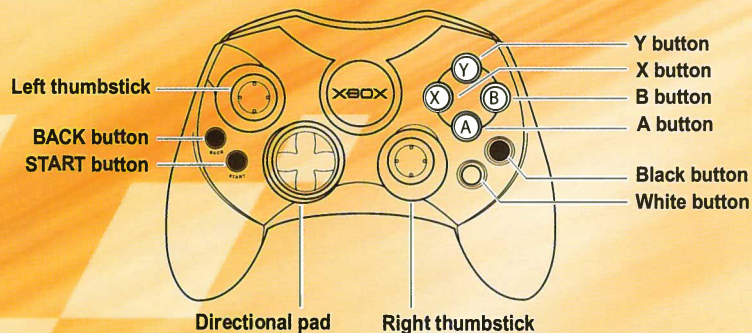
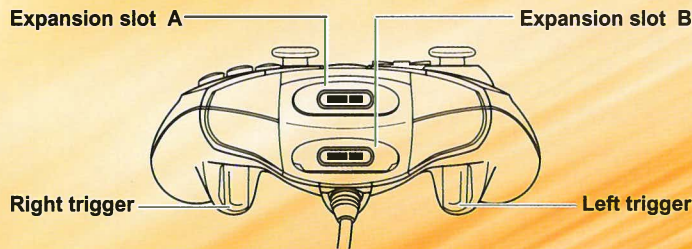



## MotoGP 2 Standard Controls

**Note:** This section outlines the standard or default controls. To customize your controls, go to the 'Settings' menu (see page 33).

<b>BUTTON</b>	<b>ACTION</b>
Left thumbstick	Leaning & Rider Position
Right thumbstick	Acceleration & Braking
A button	Accelerate
B button	Look Behind
Y button	Change View
X button	Auto Brake & Reverse
White button	Manual Gear Shift DOWN
Black button	Manual Gear Shift UP
Right trigger	Front Brake
Left trigger	Rear Brake

**Note:** To Powerslide, double tap the accelerator while cornering.

## Introduction

The best just got better. Welcome to *MotoGP 2* - the most thrilling, critically acclaimed and technologically advanced motorcycle racing game of all time. Feel the power of new 4 stroke machines as you race your bike in all 16 official circuits from the MotoGP 2002 season. Compete in a full season against the best riders on Earth, complete with over 50 new bike based challenges. Or, race against friends and rivals online via *Xbox Live*. Now it's not enough to think that you are the best - you have to prove it to the world. *MotoGP 2* brings you the excitement, danger, glamour and thrills of the most exciting motorsport on Earth!

## The Race Screens

*MotoGP 2* has a number of different and exciting game modes: the Quick Race blast around the track; a complete 16 track MotoGP season in Career Mode; or the Xbox Live enabled Multiplayer mode. These are the in-game screens for all available *MotoGP 2* modes. Study them carefully and get to know where everything is, because at the speeds you'll be traveling, you'll need to absorb all the information at a glance!

### Quick Race

Jump right into the action and take part in a three-lap race on your choice of tracks. Only the first three tracks in the championship, or tracks unlocked in the Stunt or the Career game modes, are available for selection.

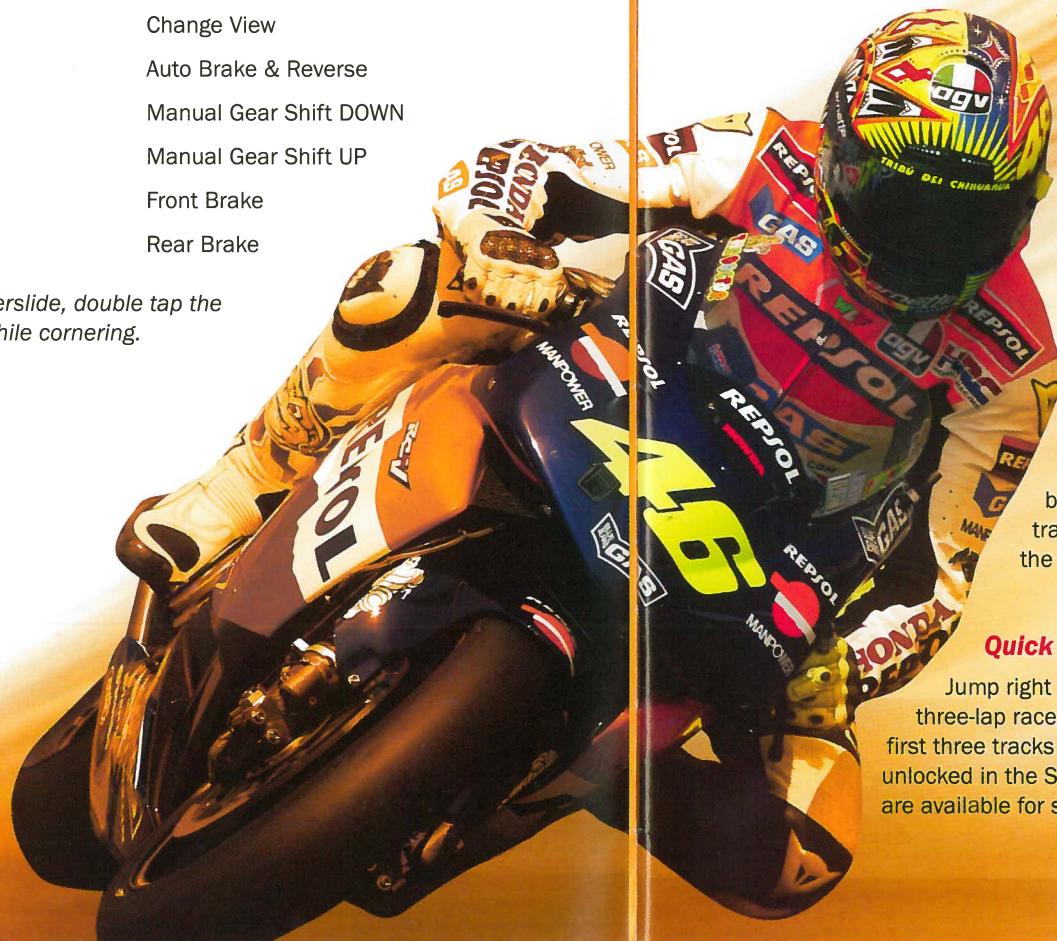



## Career Mode

A complete simulation of the 2002 *MotoGP* Grand Prix Series. You can create your own rider in this mode who can be used in all of the other *MotoGP 2* modes, which can improve using the interactive experience credit award system (see page 19).

## Stunt Mode

Race through all the tracks in the 2002 *MotoGP* season! It's a challenge against the clock and all the other top riders as you try to hit those checkpoints in time. Good scores will unlock extra *MotoGP 2* game features (see page 20).

## Time Trial

Race against the clock to get the fastest lap times ever! This mode features the 'ghost bike' option that lets you race against your best track times. Note that only tracks unlocked in the Stunt or Career Mode are available in Time Trial.



## Getting Started

### THE GAME MENU SCREEN

After the opening screens and animations, you will come to the Game Menu screen where you can choose between Single and Multiplayer modes, change the Settings, or check out the Extras.

- Cycle through the available game modes using the D-pad or left thumbstick UP/DOWN.
- Press the A button to select a mode (if you make a mistake you can press the B button to go back one screen).

### Quick Race

This is a quick fix, three-lap single race adrenaline rush for anyone who hasn't got the time to take on the Stunt or Career modes. Quick Race lets you race using tracks, bikes and riders 'unlocked' in other game modes.

- Select Quick Race.
- Choose a Track.
- Choose a Bike & Rider.
- Choose a Difficulty Level.

You'll start a Quick Race in a random position on the first two rows of the starting grid.





### Player Assist Arrow

At times in the race you will see assist arrows on screen. When approaching a corner, the arrow changes to red if you are traveling too fast. A double arrow sign indicates that you're riding in an opponent's slipstream, which will merit a subtle boost in speed and acceleration.

### Map and Rider Position

The screen shows a map of the track with your rider's position marked by a flashing red marker. Other riders in the race are marked by grey dots. In Multiplayer mode, each human player will have a different colored flashing marker.

### Rider Time Difference

This shows the time difference between your rider and the riders directly in front of and behind you. A plus sign preceding the numerical time difference shows how far behind the next competitor you are, while a minus sign indicates how far behind you the nearest rider is.

### Riders

There are 22 riders available in *MotoGP 2* – all taken from the real 2002 season. Also available are any riders you have created and saved to the Xbox hard disc or imported from a Memory Unit.

### Tracks

Initially only the first three tracks are available, but as you progress through Stunt or Career modes, you can unlock the other circuits.



### Bike and Rider Selection

The Bike and Rider Selection screen is the same in all the game modes, however the Career Mode also features a Create Rider screen.



On the left of the screen is a list of the riders, their team, and bike that you can use in the game. Custom riders created by you are shown at the start of the list, followed by the names of actual *MotoGP* riders. Locked (or unavailable) riders are indicated by the word 'Locked' over the bike and rider. You can cycle through the list of names and faces while a large window on the right displays the rider, bike, crash helmet, and team logo.

The lower panel shows the rider's experience credits. The yellow bars indicate the rider's level of experience in:

- Corning
  - Braking
  - Top Speed
  - Acceleration
- Cycle through the available list of riders using the D-pad or left thumbstick LEFT/RIGHT.
  - Use the right thumbstick to zoom in and out on the bike and rider.
  - Press the A button to select the on-screen bike and rider.



## Track Selection

The Track Selection screen is used in Quick Race, Career, Stunt and Time Trial game modes.



The right-hand side of the screen displays the track graphic including its name, location, length, number of bends, and the host nation's flag.

Cycle through the tracks that have been unlocked in the Stunt and Career modes. Tracks that have not been unlocked are 'grayed out.'

To the right of the track graphic are the selectable race weather conditions:

- **Sunny:** sunny weather with dazzling sunshine.
- **Clear:** standard conditions, cloud cover with intermittent sunshine.
- **Raining:** cloud cover, light fog and rain with a partially wet track.
- D-pad or left thumbstick LEFT/RIGHT cycles through the weather conditions.
- Press the A button to confirm.

*Alternatively:*

- Press the Y button to select a random track from those that are currently unlocked, and random weather conditions. Pressing the Y button on the Quick Race track select screen changes the currently highlighted track to Mirrored, Reversed, or Reversed Mirrored.

## Ready to Quick Race

Once you have made your selections, your bike and rider will appear on the starting grid ready to race. Check your bike controls, wait for the lights to change and then GO!! Be careful not to over rev on the starting grid as you may end up burning out. Try instead to balance power and control. At the end of the race you will see a results screen showing all the riders' finishing positions.

## Career Mode

- Select Career Mode on the Game Menu screen and you will be shown the Load/Create Rider screen that allows you to continue Career Mode with a previously saved rider (from a maximum of 10 save slots) or start a new rider.
- In the Create/Load Rider screen customized riders can be deleted by highlighting the desired rider and pressing the Y button.

Continuing with a previously saved rider will take you to either the GP Status screen (if the saved game is about to start a new Grand Prix round) or the Race Schedule screen (if the saved game is in the middle of a Grand Prix round).

Selecting a new rider will take you to the Create Rider screen, allowing you to create your own rider with which to race, specifying appearance; name; number; nationality and team.

## Create Rider Screen

This option is only available in Career Mode.



Here you can customize your rider and then save the information (physical appearance, experience credits and progress in the Grand Prix Championship) for future use in all game modes.



### **Customizing a Rider**

Customizations are not purely aesthetic as liveries are matched with bikes, however riders created here will develop in skill and ability dependent upon your performances.

Name – Enter a rider name.

Nationality – Choose your rider's nationality.

Leathers – Choose a design for your rider's leathers. The colors used within the design are customizable. A color 'picker' is provided for each of the three colors incorporated in the design.

Number – Choose a racing number for your rider.

Bike – Choose the bike model and the fairing style from a selection of different designs. As with the leathers, the colors used within the design are customizable.

Logo – Choose up to 8 layers of text or shape from box; circle; semi-circle; triangle, then resize; rotate; skew; move; and color each one to make your own designs on the side of the bike.

Team Name – Enter a name for your team.

### **Rider Credit Distribution Screen**

This screen appears after the Create Rider screen, and after a race in the Career Mode, if your rider has placed in the top 15. Here you are given 18 rider experience credits to distribute among the four areas of rider ability: Cornering, Braking, Top Speed and Acceleration.

### **Cornering**

Anyone can ride fast in a straight line, but skill in cornering separates the winners from the losers. Good cornering technique means entering the corner wide and then dropping the bike on its side at a horrifyingly acute angle. Then, accelerate out of the turn and allow the rear end to slide out until you are straight again.

- The further the bike can be leaned over, the greater the possible turning circle and cornering force the vehicle can attain.

Rider dexterity also plays a huge part in cornering. The bike and rider are subject to enormous g-forces while cornering, so only the most dextrous riders can hope to achieve the bike's maximum potential in this key area.

### **Braking**

Unlike cars, bikes allow the rider to control both front and back brakes, so good braking technique can shave precious seconds off your lap time. An increase in braking ability means you can approach bends faster, brake later and harder to get ahead of the pack, before accelerating out of the bend.

### **Top Speed**

A Grand Prix motorcycle engine has incredible power. Bikes can weigh over 130 kg yet produce up to 180bhp. Throttle control is a very precise technique: a fraction too much, and the bike will throw you, a fraction too little and the competition will leave you behind. Increasing the rider's top speed will give your rider the ability to manage this powerful machine, allowing you to achieve the maximum performance out of the engine.

### **Acceleration**

Effective acceleration on a Grand Prix motorcycle means shifting through the gears as quickly as possible. The biggest concern for a rider is the loss of time in shifting, so to achieve top speeds you must cycle through the gears efficiently. In *MotoGP 2*, a rider with improved acceleration ability performs fewer 'accidental' wheelies and has more power when needed (i.e. when exiting corners). The degree of stability as the rider shifts gears is also increased, meaning a smoother ride at more consistent speeds.

### **GP Status Screen**

Once you have chosen your rider and distributed experience credits, you will be taken to the GP Status screen showing:

- all Grand Prix events on a World Grand Prix Map with individual rounds shown as Locked, Completed, or Current (next).
- the amount of rider experience credits gained alongside each completed Grand Prix, as part of the total number possible.
- information on your Grand Prix status, with the next (or current) round highlighted, plus your rider's overall rankings.

This screen also allows you to race on previously raced tracks in the Career mode to help you gain more rider experience credits.



To choose a difficulty level, go to Options (press the Y button) within the GP Status screen, select difficulty and choose between Rookie, Pro, Championship, and Legend.

### Race Schedule Screen

Once you have selected to enter a Grand Prix from the GP Status screen, you will be taken to the Race Schedule screen that shows an overview of the four weekend Grand Prix events.

### Challenges

A variety of challenges are held on each track, helping you to improve your bikes performance. Challenges are the best way to get to grips with the skills you'll require in *MotoGP 2*. These challenges focus on specific aspects of bike handling and are available on circuits you have raced in the GP series. They can be done in any order and at any time once that track is unlocked.

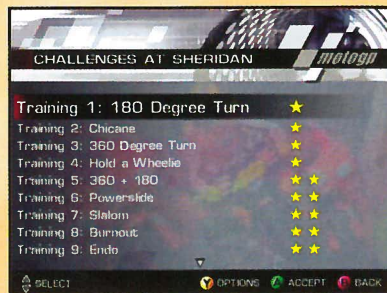

There are 61 challenges to complete three difficulty levels. Every completed Challenge results in one experience credit, which can be allocated to any of the four areas of rider ability in the Rider Credit Distribution Screen.

Of the 61 Challenges there are seven different types:

- Racing Line
- Follow the Leader
- Slalom
- Speedtrap
- Training Maneuvers
- Wheelie
- Powerslide

### Challenge Time Remaining

This shows the time remaining on a Challenge and will flash red when a time penalty is incurred.

### Practice

This is an opportunity to familiarize yourself with the track and weather conditions, but is not compulsory.

### Challenge Time Remaining

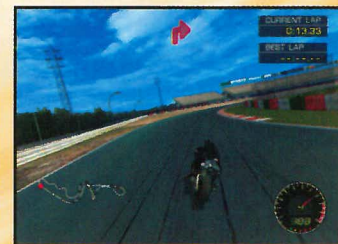
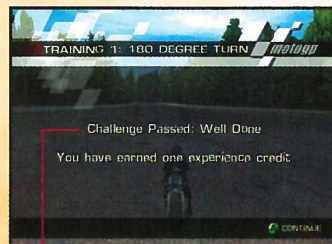

### Challenge Success/Fail Messages

### Qualify

You have a maximum of 10 minutes to achieve the best lap time possible, with competitors' times determining the final grid positions in the race. Competitors start from a staggered, rolling start on the track and at the end of every lap you are shown the lap time and qualifying position relative to all the other riders for that lap.

### Rider and Helmet Indicators

The name and position of the rider is shown along with color-coded helmet icons:

- Grey helmet – below personal best
- Blue helmet – personal best time
- Red helmet – pole position

### Qualifying Time Remaining



### Rider and Helmet Indicators

The helmet icons are linked to checkpoints around the track and show your cumulative time up to that point.



## Race

This is the main event of the Grand Prix, where you will have to complete 3 laps of the circuit in an all-out race for the finish line.

If you choose to enter the main race without first completing the qualifying round, you will begin in 20th place on the starting grid.



## Restart Round

Choose this option if you want to race again to gain higher credits. This option will be grayed out until you have raced the track.

## Championship Points System

Your progress to the Championship is defined in terms of points gained at each race event. This is based on the scoring system of the real *MotoGP* sport:

- To win the *MotoGP* championship, you must gain more points than the other competitors after all races have been completed.

## Gaining Rider Experience

Rider experience credits are awarded to riders finishing in the top 15 in a Grand Prix event:

	Rookie	Pro	Championship	Legend
<b>1<sup>st</sup> Place:</b>	3 Credits	4 Credits	5 Credits	6 Credits
<b>2<sup>nd</sup> Place:</b>	2 Credits	3 Credits	4 Credits	5 Credits
<b>3<sup>rd</sup> Place:</b>	1 Credit	2 Credits	3 Credits	4 Credits
<b>4<sup>th</sup> Place:</b>	1 Credit	1 Credit	2 Credits	3 Credits
<b>5<sup>th</sup> Place:</b>	1 Credit	1 Credit	1 Credit	2 Credits
<b>6<sup>th</sup> to 15<sup>th</sup> Place:</b>	1 Credit	1 Credit	1 Credit	1 Credit

Once they have been awarded, you can distribute these credits among the four rider abilities (see page 11). With 18 points initially awarded, 96 available from racing and 61 available in challenge mode, there are 175 points available in total.

According to how many races you complete, the total number of points assignable to one skill is 50.

## Completing the GP Series

If you complete the first GP Championship, you will be allowed to continue into the next season to race the entire GP Championship again using the same rider, further improving your rider's skills.

It is possible to alter the difficulty level during a GP series, but in order to unlock Legend mode you must complete the entire GP Series in Championship mode from beginning to end. Switching to Championship partway through a Series started in Pro or Rookie will not unlock Legend.





## Stunt Mode

The Stunt Mode gives you a quick and simple 'arcade style' charge through the MotoGP Championship, allowing you to race on all the tracks available in the game in three-lap races using a checkpoint system.



## Stunt Total

Running tally of points scored in Stunt mode.

## Checkpoints

To succeed in Stunt mode, you will have to finish each lap of the track inside an allotted time. Note that any time remaining on the counter as you cross a checkpoint is added to the total time limit required to get to the next checkpoint.

## Points

Any time left on your checkpoint clock at the end of each lap is converted into points, which are used to unlock extra features in the game, such as extra riders and bikes. Your finishing position in the race also determines your starting grid position in the next race.

## Bonus Points

In Stunt Mode you can also pick up bonus points if you perform tricks, stunts or display excellent riding skills. Possible tricks include: wheelies, endos, clean sections (staying on the track), burnout, overtake, power slide, and jump. These bonuses are added to a running total Stunt score that's updated throughout the race.

## Starting Off

Select Stunt Mode from the Game Menu and you will be brought to the Stunt Mode menu screen and given the following options:

- Start Race
- Select Rider
- Select Track
- Difficulty

## Time Trial

Time Trial mode allows you to practice your skills on any previously raced tracks and to improve your best lap times. You will race alone in this mode.



Select a Bike, Rider and a Track (from the list of unlocked tracks). You can race an unlimited number of laps and, if you achieve a new lap record, you will be able to place your name alongside the record time.

Time Trial also allows you to race against a 'ghost' bike and rider that replicates your best performance.



## Multiplayer Races

Select the Multiplayer option in the Main Menu screen. You can play *MotoGP 2* in Split-Screen mode via the Xbox System link or online via Xbox Live with up to 4 players per console (to a maximum of 16 players per race).



### Multiplayer Lobby

Once a game is selected or created and each player has chosen a bike from the bike select screen, the player(s) are taken to the lobby where everyone waits until all players are ready to begin the race. Once confirmation is complete, all players are lined up on the starting grid and the race will start.

Xbox Live, Split Screen and System Link will allow the player to play against other people using either preset or customized game types. Some preset game types will be available to the player with default settings, but these can be customized, renamed and saved out onto the Xbox hard disc by the player.

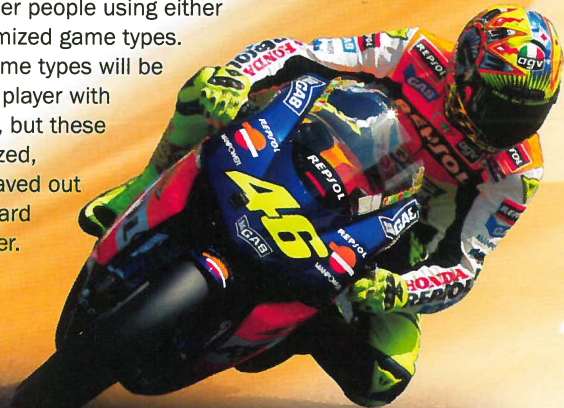

### Split Screen

Select 'Split Screen' from the Multiplayer menu. If you only have one player signed in, you will be asked to sign in more players. Once you have selected a game mode, a bike and in some types of game mode, a track, you will go through the lobby, which is outlined in detail below.

- The two-player game has an adjustable horizontal/vertical split which can be changed in the start menu.
- The three/four-player game has a cross split.

### System Link

*MotoGP 2* allows multiple Xbox video game systems (16 maximum) to be linked together or through a LAN:

- Select 'System Link' from the Multiplayer Game screen.
- It will search for a session to join and give you the same options as in a *Live* Optimatch search list.
- Select your rider from the Rider Select screen.

The program will search for a *MotoGP 2* game already underway for you to join. If you want to set up (host) your own game, press the A button and you will go to the System Link Lobby Screen. This lists all the linked players and race settings.

- The game will start when all players are ready or when the timer runs out.
- Information about the current game is displayed on the Lobby screen, as well as a scrollable list of all the players.
- Press the A button when you are ready to play.
- The host of the game (the player who created it) can press the Y button to access the Lobby Options screen.
- Press the B button to cancel the session. Press the Y button to bring up the Options Menu and change riders.





## Live Play

The player will need to sign in to access any of the game modes on the *MotoGP 2 Live* disc. You will be offered up to four accounts or guest options depending on how many people are playing, (*MotoGP 2 Live* supports up to 4 player split screen for any one Xbox console). Once the player(s) sign in, he/she is taken to the Main Menu where several options are available:

- Quick Match
- Optimatch
- Create Session
- Friends
- Scoreboards

## Xbox Live

Once the player has selected *Xbox Live*, they are given the following options:

- *Quick match* – automatically joins a session so you can race immediately.
- *Optimatch* – allows the player to enter search terms describing what sort of game they want, then looks only for games of that type.
- *Create session* – creating a session means that you are the host player and you can set the properties for the game by either selecting a preset game type or creating your own game type from the list of game options.
- *Friends* – shows which of your friends are online and people requesting to be your friend.
- *Scoreboards* – this is where the online player statistics are kept, such as high score tables, friends statistics and world statistics.

## Multiplayer Race Settings

Any player can alter the race settings once they have selected a rider and are in the Split Screen Lobby. In *Live* or System Link play, only the session host can choose the track and alter the Game Mode settings. Any player can alter their rider, its customization, and bike setup.

### Lobby Options (press the Y button):

Friends: *Xbox Live* account holders only, but this is visible in System link and Split screen if one player has a *Live* account.

Scoreboards: *Xbox Live* account holders only.

Players: *Xbox Live* and System link sessions only.

Select track

Select rider

Bike setup

Edit game mode

Track progression: Single track; Grand Prix; Random  
 Scoring: Championship; Tag mode; Stunt mode; Qualify  
 Grid position: Last race; Qualify; Random;

Session ranking; Inverse last race; Inverse ranking

Laps: One; Two; Three; Four; Five; Ten; Fifteen;  
 Twenty; Real

AI bikes: Off; Rookie; Pro; Champion; Legend

Collisions: On; Off; Forward only

Off-road sim: 0% - 100%

Handling sim: 0% - 100%

Collision sim: 0% - 100%

Unlockables: Filter type; Brring ding ding; Turbo

Save custom game mode

Reset player rankings

Settings

- Press the A button to confirm a settings change.



## Game Mode

These game modes are available in Split screen, System link and Xbox Live. Choose from 7 game modes explained in detail below.

- Quick race
- Championship
- Grand Prix
- Tag mode
- Stunt mode
- Qualify
- Custom (only appears if a Custom Game Mode is saved in the Edit Game Mode).

### Quick Race

Select your rider and track from any unlocked options. Once selected, you'll be in the Lobby. Press the Y button for game options such as in the Multiplayer Race Settings.

### Career Mode

Play over a series of races. The winner is, the rider with the highest total score from all races. If Career Mode is selected, then the number of tracks and track order options will become available.

Career Mode will run similarly to GP Series with an optional qualifying round and then the Championship race. As with all other game types, Career Mode can be altered through an options list to suit the players needs.

The Championship race will run in the same way as GP Series with a set order of tracks played through one after the other until they are all complete. Career Mode can be played with or without qualifying sessions. If played without the qualifying sessions, rider order on the starting grid can be determined via a set of options available before the race.

Select your rider and move forward to the Lobby where the Multiplayer Race Settings are available.

### Career Mode Scoring

Players will earn championship points for each race completed, with the winner being the player with most championship points. The points for each race are as follows:

<b>1<sup>st</sup> place</b>	25pts	<b>9<sup>th</sup> place</b>	7pts
<b>2<sup>nd</sup> place</b>	20pts	<b>10<sup>th</sup> place</b>	6pts
<b>3<sup>rd</sup> place</b>	16pts	<b>11<sup>th</sup> place</b>	5pts
<b>4<sup>th</sup> place</b>	13pts	<b>12<sup>th</sup> place</b>	4pts
<b>5<sup>th</sup> place</b>	11pts	<b>13<sup>th</sup> place</b>	3pts
<b>6<sup>th</sup> place</b>	10pts	<b>14<sup>th</sup> place</b>	2pts
<b>7<sup>th</sup> place</b>	9pts	<b>15<sup>th</sup> place</b>	1pt
<b>8<sup>th</sup> place</b>	8pts		

During this course of the Championship, the player will be able to view the amount of points accumulated by each of the riders within the championship, gauging their progress against other competitors.

In order to win the Championship, the player will need to attain more points than the other competitors after all races have been completed.

All scoring can be turned on or off with all three modes of scoring available if the player so desires for one race/championship. If all scoring is set to 'off' then the winner of the race is the first across the finish line, it will be shown in the results screen.

- Championship – Scoring modeled after the world sport where players are scored on their finish position (see Championship Scoring).
- Tag – Players are scored on which sections of the track that they own (see Tag Scoring).
- Stunt – Players are scored on their ability to do stunts, tricks, etc. with a running tally. Points for each trick can be individually altered and turned on or off depending on how the host wants to score the Stunt Mode.
- Qualify – Qualify Scoring is basically just the best lap time of each player within the qualifying period (see Qualifying Results). The qualifying period is adjustable so that the host player can set a session length, however it defaults to 10 minutes.



## Tag

Tag mode is checkpoint racing. The race will take place over a user-defined number of laps. The track is divided up into sections and the rider who completes that section of the track in the quickest time will then 'own' the section until another player beats that time.

### Tag Scoring

*Monopolization* – You are awarded points for owning a section of the circuit and the score is calculated according to your section time. The section owner can boost their score by completing an already owned section in a quicker time.

*King of the Corner* – A continuous score whereby the longer you hold/own a corner of track the more your score increases.

*Winner Take All* – You are also able to “steal” points from other riders by beating their section time and owning that section. You will gain a point and the previous owner will lose a point.

## Stunt mode

The Stunt mode will provide a quick and simple ‘arcade style’ of championship progression, focusing on accessibility and addictive gameplay. The player will be able to progress through all of the tracks available within the game with a simple check point system ensuring a competitive level of progression.

### Checkpoints

In order to progress throughout this game mode, players will be required to successfully complete a three-lap race of each track within the game by reaching each successive checkpoint in time.

At the start of the race, the players will be allotted a certain amount of time within which to get to the next checkpoint (i.e. to complete the lap). Reaching the checkpoints in time will add further time to the next checkpoint limit, giving you more time to complete the race.

Any time left on the player's checkpoint clocks at the end of the race will be converted into points. Riders who failed to complete the checkpoints in the time allotted, but advanced onto subsequent rounds due to other players' performance, are awarded no points.

## Tricks and Stunts

Extra points are awarded for performing stunts or tricks such as wheelies, endos, power slides, burnouts, jumps, overtaking, etc. The points are awarded for each individual stunt, but repeating stunts leads to lower scores. Try to vary the stunts to achieve higher scores.

### Clean Section Bonus

The Clean Section Bonus is the highest scoring bonus in the game. To achieve it you have to ride smoothly, avoiding crashes, collisions, and spins through certain sections of the track – this is the true test of the skilled rider.

### Stunt Scoring

A running tally of the players' score is kept throughout the race in the top right hand corner of the screen. As the player performs his/her tricks or stunts, the points rack up. When the stunt is completed, the points are added to the overall score. There is a slight delay between the stunt finishing and the points being added (a matter of a few seconds) where the player must not crash or leave the track or he/she will forfeit his/her points for that stunt. More than one stunt can be performed at any one time, for example: overtaking a rider while performing a wheelie.

The player's actual finishing position within the race will determine their overall starting position upon the grid within the next race. This can be altered using the Options menu.

## Qualifying

If the players choose to participate in qualifying, their times will determine their starting grid position. A qualifying round will occur before each race within the championship. Qualifying will be 10 minutes long with all bikes on the track starting from the pit lane. Displayed on the screen will be:

- Timer for the current lap
- Best lap
- Current position at the end of each lap
- Time remaining
- Helmet system



## Qualify Results

If desired, the player will be able to exit qualifying before the end of the session. If the player decides to do this they will be taken to a results screen until all competitors have finished their final laps. The results screen will show the best lap times and their position on the grid. This screen can also be watched during qualifying to provide a real time indication of the qualifying times, giving you the opportunity to post new lap times if required. The player will have the option to watch the race from cameras placed at intervals around the track to see how the other riders are progressing.

Once qualifying is complete all players are taken to the results screen where they can see the final grid position. The bikes are then placed on the grid where the championship race will start. If the players are using Split Screen multiplayer once the qualifying round has finished only one full screen results screen will be displayed.



Rank	Rider	Lap Time
1	Valentino Rossi	0:17.13
2	Lucio Caporossi	+0.75
3	Carlos Checa	+1.78
4	Max Biaggi	-2.48
5	Daijro Kato	-2.85
6	Akira Ryu	-3.83
7	Olivier Jacque	+4.68
8	Shinya Nakano	+5.12

## Player Options

Player options can be accessed through the lobby or via the Pause menu during a race. Here the players can alter the set up to suit themselves. In four player split screen, each individual player will have the ability to alter these settings, but only one player in this instance can alter settings at any one time.

If a player pauses the game, it will be paused for all of the other players, as well. The game will resume at the point on the track that it was paused.

The amount of options open to each player will vary depending on where the option screen is accessed. The full compliment of options is available from the Lobby screen, and a cut down version is available from the Pause menu during a race.

## Replay Cameras

Replay cameras let you check out those fantastic bike maneuvers in your current race and watch them again and again from a number of different views, in either normal or slow speed. You will be given the option to watch a replay when you finish a race or directly from the Game Menu (if the replay has been saved). A replay console with VCR-type buttons gives you a number of view options (see below).

- Use the D-pad or the right thumbstick LEFT/RIGHT and UP/DOWN to highlight an option.
- Press the A button to select.

## Playback

- *Standard Playback/Slow Motion Playback*: Press once to play back the race at normal speed, press again to play back the race at half normal speed. Pressing this button again will then resume normal play mode.
- *Fast Forward*: Rapidly advance the race by jumping to the next keyframe when the button is clicked.
- *Rewind*: The replay will be rewound by jumping to the previous keyframe when the button is clicked.
- *Pause*: Pause the replay. Press Pause again to 'frame step' ahead.
- *Stop/Quit*: Stops the replay and takes you back to the Main Menu of the race mode you are in.
- *Hide*: Hides the replay controls for a full view of the relay action.
- *Camera*: Cycle through a variety of camera angles, full details on page 32.
- *FX*: Watch the replay in any cheat mode that you have unlocked.



## Rider Selection

Pressing the A button when this button is highlighted cycles through all the other riders in the race. Pressing the B button will cycle backwards through the selection. Your rider's name is highlighted and is always the default rider that is initially featured.

## Camera Selection

Pressing the A button when this button is highlighted cycles through a variety of different camera angles with which to view the replays. Pressing the B button will cycle backwards through the selection.

- TV: A number of television cameras are placed around the edge of the track (as featured on TV).
- ACTION: More dynamic types of TV cameras, changing more frequently.
- HELICOPTER: An aerial camera view from a helicopter circling the track.
- CHASE 1, 2 and 3: Viewed from one of three different third person viewpoints of a selected rider.
- COCKPIT 1 and 2: Two views from the cockpit (behind the bike windshield) of the selected rider.
- ON BOARD FRONT: Camera mounted on the front wheels (looking forward).
- ON BOARD REAR: Camera mounted on the rear wheels (looking backward).
- BIKE 1 to 6: Six slightly different types of camera angles that rotate around or focus on the player-selected rider.
- SHAKE: Views crashes as if from a moving, shaking bike.
- AUTOSWITCH: Switches automatically between all cameras.

## Settings Menu

The Settings Menu can be accessed from the Game Menu screen and allows you to adjust various in-game options:

### Game Settings

#### Sound settings

- Music Volume (0-10) - adjust the volume of the in-game music.
- Sound FX Volume (0-10) - adjust the volume of all sound effects.
- Select Soundtrack This allows you to choose which music soundtrack is played in-game from:  
- *MotoGP 2* tunes.  
- *MotoGP 2* tunes (shuffled).  
- Any player created soundtrack.

#### Game settings

- Indicator Arrows switch on/off the graphical player assistance icons.
- Powerslide Sensitivity (0 - 10) - vary the sensitivity of powerslides.
- Vibration (0 - 10) - vary the Xbox Controller vibration feedback function.
- Gears select an Auto or Manual gearbox for your bike.
- Display Rider Names show in-game riders with their names displayed above their heads (On, Humans Only, or Off).
- Quick Race Laps set the number of laps in a Quick Race from: 1, 2, 3, 4, 5, 10, 15, 20, or Real (the actual number of laps that are raced on each track).
- Grand Prix Race Laps set the number of laps per race (in a Grand Prix Series): 3, 5, 10, 15, 20, or Real (the actual number of laps that are raced on each track).



## Control Settings

This screen allows you to choose from a selection of built-in control styles to suit your way of holding the Controller.

- Browse by pressing the D-pad UP/DOWN.
- Press the A button to select.

## Online Settings

These options will be grayed out if you are not playing online.

**Voicemask** Use this option to alter the sound of your voice when speaking to other players

**Appear offline**

## Guest Riders

This option allows your friends who don't have their own Xbox Live accounts to play on Xbox Live with you on your Xbox video game system. Guest Riders can also be created for any user who wants to play in Multiplayer mode and doesn't want any progress data saved to the hard disc.

## Extras

The Extras menu is located in the Game menu screen and contains the following screens:

### View Replay

View any replays recorded and saved to the Xbox hard disc (see above for details).

### Unlockables

This option displays all the tracks, highlights, riders, cheat modes and Legend difficulty that you can unlock during the game.

### Videos

This displays a list of all unlockable videos from the game and allows you to view any that have already been unlocked (press the A button).

### Game Credits

This option displays the game credits.

## In-Game Options

Press START during a game to open the Pause menu and you will see the following options:

- Resume Race: continue racing or un-pause the game.
- Restart Race: restart the current race.
- Quit Race: quit the current race and return to the Main Menu.
- Friends: view online status of all friends.
- View Replay: view a replay of the current race up to that point.
- Settings: adjust sound, control settings, and more from this screen.
- Press START to select highlighted option.

## Stunts and Special Maneuvers

A number of exciting bike stunts and special maneuvers can be carried out in *MotoGP 2*. These are extremely important in the Career and Stunt modes where points can be picked up for performing the moves correctly.

### Powerslide (Spinning the Rear Wheel)

Powerslide around corners by fully releasing the accelerator (A button or right thumbstick) before immediately re-applying. This is an effective way of correcting if you are too wide in a corner.

### Wheelies

To perform a wheelie, shift the rider to the rear of the bike and pull back on the left thumbstick. You have to keep the speed constant and be careful not to lean too far back.

### Endos

To execute an endo, apply the front brake while leaning the rider forward. Again, balance is the key to avoid crashing the bike.



## Doughnuts

To perform a doughnut, lock the front brake and open up the throttle. Then lean in either direction and the bike will start to turn on the spot.

## Rear Wheel Skids

You will be able to perform skids through independent use of the rear brake. Tapping the rear brake button as you go around corners will make the back wheel of the bike slide out a little, allowing you to create a sharper turning circle when navigating bends. This particular maneuver can be compared to the 'power sliding' technique often carried out in the races. However, if the rear brake is applied for too long when the bike is turning, it could lock, resulting in a 'low-side'.

You can also use the rear brake to perform dramatic skids when braking in a straight line. If you turn the bike at the same time as skidding the rear wheel, you will be able to swing the wheel around to rotate the bike in a complete circle. Applying the front brake after you have started swinging the bike around in this manner will stop the bike rotating too far. However, if you attempt to execute this particular maneuver at too high a speed, the bike may 'high-side'.

## Burnouts (Wheel Spins)

### Static Burnout (wheel spin on the spot)

The bike must be stationary as the stunt is carried out. First, the front brakes need to be applied to lock the front wheel as the engine is revved to cause the rear wheel to spin.

### Rolling Burnout (spinning the rear wheel of the bike as you creep forward)

To perform this stunt, you must apply the front brakes to lock the front wheel as you rev the engine and make the rear wheel spin. Then you must reduce the amount of pressure applied to the front brake allowing the bike to creep forward as the rear wheel spins frantically.

## Credits

### THQ International

**Director of European Product Development**  
Mike Gamble

**Assistant Producer**  
Iain Riches

**Head of Brand Management**  
Michael Pattison

**Brand Manager**  
Jennifer Wyatt

**Associate Brand Manager**  
Darren Williams

**UK + Export Marketing Manager**  
Jon Brooke

**Germany Product Manager**  
Markus Schuetze

**France Senior Product Manager**  
Olivier Perron

**Asia Pacific Marketing Director**  
Sophie Mavridis

### THQ USA

**Project Manager**  
Raphael Hernandez

**Associate Project Manager**  
Kathleen Nicholls

**Project Coordinator**  
Jason Garwood

**Quality Assurance Lead Tester**  
Tim Grimaud

**Quality Assurance Senior Tester**  
Kyle Carey

### Quality Assurance Testers

Anthony Backman  
Anthony Horsley  
Jon Singer  
Jasper Jan  
Jason Elliott  
Davin Cheng  
Richard Spurlock

**1st Party Submission Specialist**  
Keith Michaelis

**1st Party Testers**  
Antonio Herrera  
Mark Aviles

**Director, Creative Management**  
James Boone

**Vice President, Product Development**  
Philip Holt

**Executive Vice President - Worldwide Studios**  
Jack Sorensen

**Quality Assurance Technician**  
Mario Waibel

**Quality Assurance Database Administrator**  
Jason Roberts

**Quality Assurance Manager**  
Monica Vallejo

**Director of Quality Assurance**  
Jeremy S. Barnes

**Senior Vice President - Worldwide Marketing**  
Peter Dille

**Group Marketing Manager**  
Craig Rechenmacher

**Product Marketing Manager**  
Laura Naviaux

**Marketing Coordinator**  
David W. Newman

**Director, Public Relations**  
Liz Pieri

**Public Relations Manager**  
Reilly Brennan

**Associate Public Relations Manager**  
Erik Reynolds

**Director, Creative Services**  
Howard Liebeskind

**Senior Manager, Creative Services**  
Kathy Helgason

**Associate Creative Services Manager**  
Melissa Roth

**Packaging Design**  
K+A, Inc.

**Special Thanks**  
Mark Morris

### CLIMAX

**Producer**  
Jon Gibson

**Assistant Producer**  
Alys Elwick

**Lead Programmer**  
Shawn Hargreaves

**Programmers**  
Damyán 'Doctor' Pepper  
gavin 'elf23' norman  
Sir George of Foot  
Matthew Hill  
Peter 'Smokey' Pimley  
Dyne Physics Engine  
Chris Caulfield

**Lead Artist**  
Jason 'J' Green

**Animator**  
Gylan Hunter



## Credits

### Artists

Harvey Parker  
Henry Rolls  
Justin 'The Beaver'  
Bravery  
Lawrence 'The Lorenzo'  
Elwick  
Marco 'Coriander' Hallett  
Paul 'Meston' Meston  
Paul 'Splat' Shewan  
Fizzy Pete Butler  
Rory 'Dr Rodriguez'  
Walker  
Ryan 'Brian' Guy

### Additional Artwork

Mark Hill

### Lead Designer

Luke Smith

### Designers

Akin Marquis  
Richard Stone  
Sound  
Adam Pitt  
Keith Clarke

### QA

Steve Brocking

### Original Game

#### Also Featured:

### Producer

Rik Alexander

### Designer

Mike Patrick

### Additional Design

Alastair Cornish  
Alkan Hassan

### Additional Programming

Adam Sawkins  
Flack  
Ross Childs

### Animator

Boris Lowinger

### Artist

Jason McFee

### Additional Artwork

Barry  
Jez White

### Silly Mini Games:

#### Credits Shooter

Shawn

#### Pinball

Smokey, Rory, Jon,  
Shawn + Miguel Mera

#### Fish Bouncer

Damyán + Rory

#### Cupid

Damyán, George +  
Shawn

#### the beast

gav

#### MIS

Guy Mayhem  
Rupert Mills

#### Office Admin

Lynn Horton  
Mel Ward

#### Art Director

Craig Gabell

#### Technical Director

Greg Michael

#### Development Director

Nick Baynes

#### The Boss

Tony Beckwith

#### Another Boss

Gary Liddon

#### King

Karl Jeffery

#### Music

Psynn2 (Menus)  
Shawn Hargreaves

#### Firebird (Suzuka)

V8 Pack

#### Devil's Dice (Phakisa)

V8 Pack

#### Oil (Jerez)

Third Girl

#### 5700 cc's (Le Mans)

V8 Pack

#### Adrenalin (Mugello)

Darrin Roggenkamp

#### Fastback Reptile Combo (Catalunya)

V8 Pack

#### Gasoline Overlord (Assen)

V8 Pack

#### Sabretooth (Donington)

V8 Pack

#### Sleazy Rider (Sachsenring)

Third Girl

#### Chrome Rider (Brno)

V8 Pack

#### Eat Dirt (Estoril)

Third Girl

#### 10-4 Rocker (Rio)

V8 Pack

#### Metropolis (Motegi)

V8 Pack

#### Needle (Sepang)

Darrin Roggenkamp

#### Power Up (Phillip Island)

V8 Pack

#### Doug McClure (Valencia)

V8 Pack

#### Slipstream (Sheridan Circuit)

Third Girl

#### Cookin' on Electric (Credits)

Third Girl



**Racers...  
Start your wireless phones!**



Available From



MotoGP™ and © 2003 Dorna Sports, S.L. MotoGP™ and related logos, characters, names, and distinctive likenesses thereof are the exclusive property of Dorna Sports, S.L. and/or their respective owners. Used under license. Sprint and the diamond logo design are trademarks of Sprint Communications Company, L.P. All Rights Reserved. THQ, THQ Wireless and the respective logos are trademarks and/or registered trademarks of THQ INC. ALL RIGHTS RESERVED.



## Warranty

### Warranty and Service Information

In the unlikely event of a problem with your product ("Product"), you may only need simple instructions to correct the problem. Please contact the THQ Inc. ("THQ") Customer Service Department at (818) 880-0456 or on the web at <http://www.thq.com> before returning the Product to a retailer. Live Customer Service Representatives are available to help you Monday through Friday 9am to 5pm PST or you can use our automated systems by phone or on the web 24 hours a day, 7 days a week. Please do not send any Product to THQ without contacting us first. Your 5 digit Product Code is **52016**. Please use this code to identify your Product when contacting us.

### Limited Warranty

THQ warrants to the best of THQ's ability to the original consumer purchaser of the Product that the medium on which the Product is recorded shall be free from defects in materials and workmanship for a period of ninety (90) days from the original date of purchase. The Product is sold "as is," without express or implied warranty of any kind, and THQ is not responsible for any losses or damages of any kind resulting from use of this Product. If a defect occurs during this ninety (90) day warranty period, THQ will either repair or replace, at THQ's option, the Product free of charge. In the event that the Product is no longer available, THQ may, in its sole discretion, replace the Product with a Product of comparable value. The original purchaser is entitled to this warranty only if the date of purchase is registered at point of sale or the consumer can demonstrate, to THQ's satisfaction, that the product was purchased within the last ninety (90) days.

### To receive warranty service:

Notify the THQ Customer Service Department of the problem requiring warranty service by calling (818) 880-0456 or on the web at <http://www.thq.com>. If the THQ service technician is unable to solve the problem by phone or on the web via e-mail, he will authorize you to return the Product, at your risk of damage, freight and insurance prepaid by you, together with your dated sales slip or similar proof-of-purchase within the ninety (90) day warranty period to:

THQ Inc.  
Customer Service Department  
27001 Agoura Road, Suite 270  
Calabasas Hills, CA 91301

THQ is not responsible for unauthorized returns of Product and reserves the right to send such unauthorized returns back to customers.

This warranty shall not be applicable and shall be void if: (a) the defect in the Product has arisen through abuse, unreasonable use, mistreatment or neglect; (b) the Product is used with products not sold or licensed by Microsoft or THQ (including but not limited to, non-licensed game enhancement and copier devices, adapters and power supplies); (c) the Product is used for commercial purposes (including rental); (d) the Product is modified or tampered with; (e) the Product's serial number has been altered, defaced or removed.

### Repairs after Expiration of Warranty

After the ninety (90) day warranty period, defective Product may be replaced in the United States and Canada for US\$25.00. The original purchaser is entitled to the replacement of defective Product for a fee, only if proof of purchase is provided to THQ. Make checks payable to THQ Inc. and return the product along with the original proof of purchase to the address listed above.

### Warranty Limitations

THIS WARRANTY IS IN LIEU OF ALL OTHER WARRANTIES AND REPRESENTATIONS. NO OTHER WARRANTIES OR REPRESENTATIONS OR CLAIMS OF ANY NATURE SHALL BE BINDING ON OR OBLIGATE THQ. ANY APPLICABLE IMPLIED WARRANTIES OR REPRESENTATIONS, INCLUDING WARRANTIES OF MERCHANTABILITY AND FITNESS FOR A PARTICULAR PURPOSE ARE HEREBY LIMITED TO NINETY (90) DAYS FROM THE DATE OF PURCHASE AND ARE SUBJECT TO THE CONDITIONS SET FORTH HEREIN. IN NO EVENT SHALL THQ BE LIABLE FOR CONSEQUENTIAL OR INCIDENTAL DAMAGES RESULTING FROM THE BREACH OF ANY EXPRESS OR IMPLIED WARRANTIES.

The provisions of this warranty are valid in the United States only. Some states do not allow limitations on how long an implied warranty lasts or exclusion of consequential or incidental damages, so the above limitations and exclusions may not apply to you. This warranty gives you specific legal rights, and you may also have other rights, which may vary, from state to state.

### Warning

Copying of this Product or any of its contents or elements is illegal and is prohibited by United States and international copyright laws. Back-up or archival copies of this Product or any of its contents or elements are not authorized and are not necessary to protect your Product. United States and international copyright laws also protect this manual and other printed matter accompanying this Product. Violators will be prosecuted.

## Product Support

### Warranty and Service Information

In the unlikely event of a problem with your product ("Product"), you may only need simple instructions to correct the problem. Please contact the THQ Inc. ("THQ") Customer Service Department at (818) 880-0456 or on the web at <http://www.thq.com> before returning the Product to a retailer.

Live Customer Service Representatives are available to help you Monday through Friday 9am to 5pm PST or you can use our automated systems by phone or on the web 24 hours a day, 7 days a week. Please do not send any Product to THQ without contacting us first. Your 5 digit Product Code is 52016. Please use this code to identify your Product when contacting us.

Microsoft, the Microsoft Game Studios logo, OptiMatch, Xbox, Xbox Live, the Xbox and the Xbox Live logos are either registered trademarks or trademarks of Microsoft Corporation in the United States and/or other countries.