

SEGA

#1
ARCADE HIT!

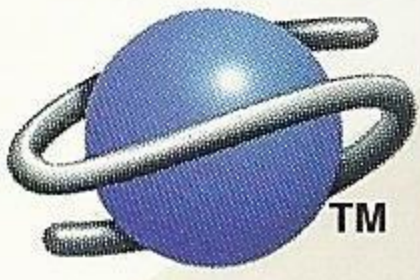

SEGA SATURN

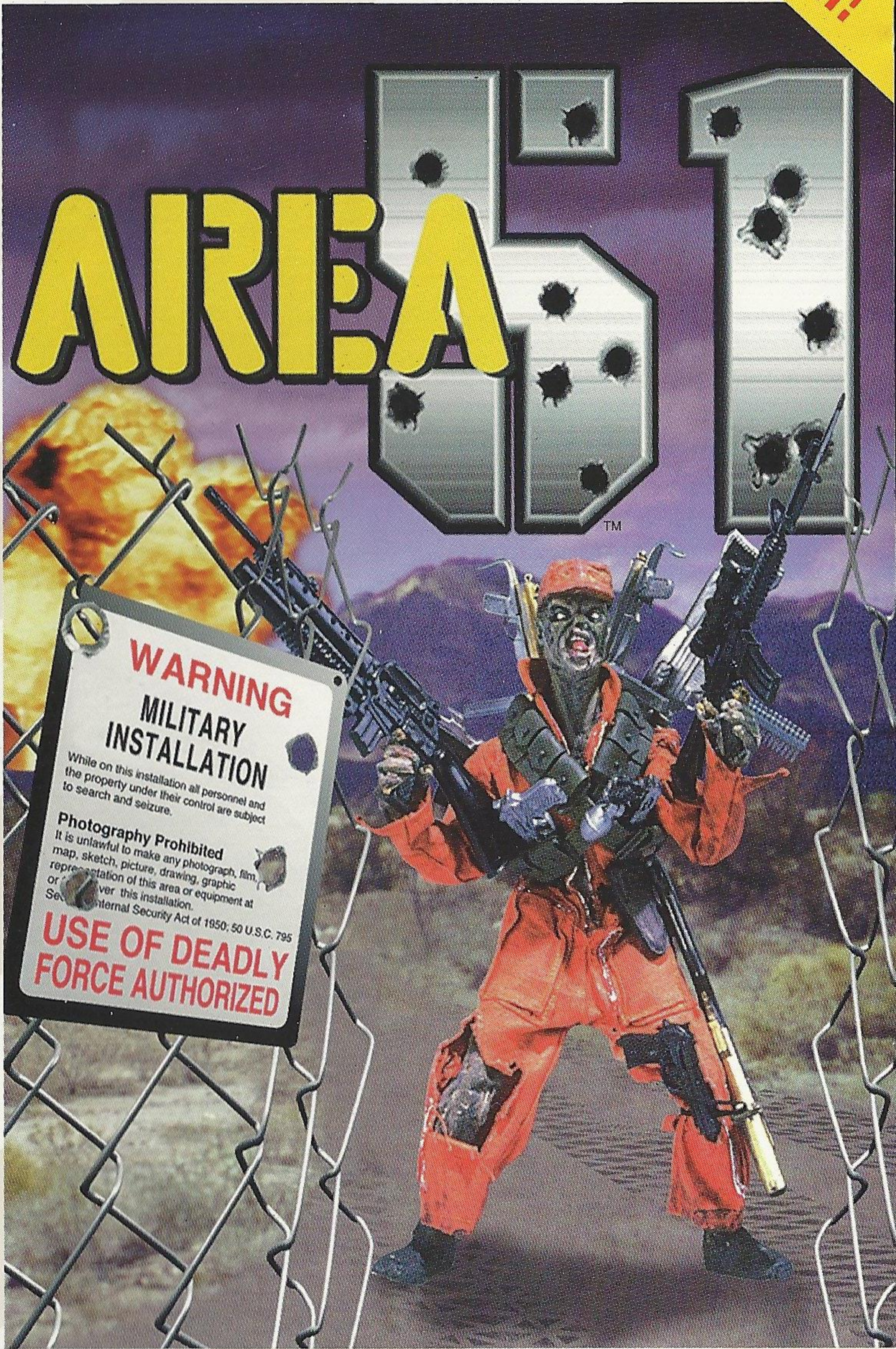

WARNING
MILITARY
INSTALLATION

While on this installation all personnel and the property under their control are subject to search and seizure.

Photography Prohibited
 It is unlawful to make any photograph, film, map, sketch, picture, drawing, graphic representation of this area or equipment at or over this installation.
 Section 795, Internal Security Act of 1950; 50 U.S.C. 795

USE OF DEADLY
FORCE AUTHORIZED



MIDWAY

LICENSED BY SEGA ENTERPRISES, LTD.
FOR PLAY ON THE SEGA SATURN™ SYSTEM.



T-9705H

WARNING

READ BEFORE USING YOUR SEGA VIDEO GAME SYSTEM EPILEPSY WARNING

A very small percentage of individuals may experience epileptic seizures when exposed to certain light patterns or flashing lights. Exposure to certain patterns or backgrounds on a television screen or while playing video games may induce an epileptic seizure in these individuals. Certain conditions may induce undetected epileptic symptoms even in persons who have no history of prior seizures or epilepsy. If you, or anyone in your family, has an epileptic condition, consult your physician prior to playing. If you experience any of the following symptoms while playing a video game--dizziness, altered vision, eye or muscle twitches, loss of awareness, disorientation, any involuntary movement or convulsions--**IMMEDIATELY** discontinue use and consult your physician before resuming play.

WARNING TO OWNERS OF PROJECTION TV'S:

Still pictures or images may cause permanent picture tube damage or mark the phosphor of the CRT. Avoid repeated or extended use of video games on large-screen projection televisions.

HANDLING YOUR SEGA SATURN™ COMPACT DISC

- X The Sega Saturn™ compact disc is intended for use exclusively on the Sega Saturn™ system.
- X Do not bend it, crush it, or submerge it in liquids.
- X Do not leave it in direct sunlight or near a radiator or other source of heat.
- X Be sure to take an occasional recess during extended play, to rest yourself and the Sega Saturn™ compact disc.
- X Keep your Sega Saturn™ compact disc clean. Always hold it by the edges and keep it in its case when not in use. Clean with a lint-free, soft dry cloth - wiping in straight lines from center to edge. Never use solvents or abrasive cleaners.

ESRB RATING

This product has been rated by the Entertainment Software Rating Board. For information about the ESRB rating, or to comment about the appropriateness of the rating, please contact the ESRB at
1-800-771-3772



This official seal is your assurance that this product meets the highest quality standards of SEGA™. Buy games and accessories with this seal to be sure that they are compatible with the SEGA SATURN™ SYSTEM.



S.T.A.A.R. POINT TEAM MISSION DEBRIEFING

WARNING!

THE FOLLOWING INFORMATION IS HIGHLY CLASSIFIED AND CONFIDENTIAL. VIEW
THIS DOCUMENT WITHIN A SECURE ENVIRONMENT ONLY.

CONTENTS

A BRIEFING TO S.T.A.A.R TEAM.....	2
GETTING STARTED.....	3
CONTROLS.....	4
MAIN MENU.....	5
BATTLE SELECTION.....	6
OPTIONS.....	6
PLAYER SELECT.....	7
MISSION OBJECTIVES.....	10
SECRET ROOMS.....	11
MISSION STATUS REPORTS.....	14
THE S.T.A.A.R TEAM.....	15
THE ENEMY.....	16
SAVING THE PLANET.....	18
YOUR NAME IN THE HISTORY BOOKS...	19
CREDITS.....	20
WARRANTY.....	21

Distribution Restriction: This publication contains technical or operational information that is for official S.T.A.A.R. use only. Distribution is limited to National Governmental agencies. Requests from foreign states under the Military Sales Program must be made to HQ, S.T.A.A.R., Fort Zachary, N.C. 43651

This publication is classified
4UREYZONLY

It shall become declassified on 28 Dec, 1999
by authority of the Strategic Tactical
Advanced Alien Response Command.

DEPARTMENT OF NATIONAL DEFENSE
S.T.A.A.R. DIVISION
LIEUTENANT GENERAL G. ILOVEWAR
COMMANDING OFFICER

From: G. ILOVEWAR, LGEN, USMC
To: S.T.A.A.R. Team Troops
Re: Alien Invasion



What you are about to read is a confidential file drafted three days ago. It was recently e-mailed to an unknown source in the CIA and has found its way into our hands. The origins are unknown at this time, but it is believed that it originated at a secret military base known as *Area 51*. This base is so top-secret that officially it *does not exist*.

Area 51 is located in a remote valley 90 miles outside of Las Vegas. It is one of the most well-guarded bases in the world. Rumors and eyewitness accounts also suggest the base harbors a deeper, more secret purpose. Secret biological testing has been reported, as well as experiments on alien bodies taken from a spacecraft which crashed near Roswell, New Mexico in 1947. Over the course of the last 48 hours, the base has become overrun with mutating alien creatures and all contact has been lost. Security around the base is so critical and tight that it isn't handled by the military. Instead, it is contracted out to a privately run paramilitary force. We now know that this force and all of its weaponry has also been overtaken.

The invasion has not taken place from the air. Instead, an alien infection has spread out of the underground laboratory area to other parts of the base. The infection brings forth three separate, very painful stages of a gruesome alien transformation where the human body is used as an incubator to grow a new combination of human and alien DNA. The product of this alien transformation is now our enemy. Refer to **The Enemy** pg. 16, of this document for photos and details on the three mutation stages.

This file was obviously drafted by a trained soldier during the last hours of his life. It describes a detailed method of invading the base to attempt an extermination of the alien presence. Follow the instructions given in this document, to the letter. Portions of the text have been edited by S.T.A.A.R for specific purposes. The fate of humanity hangs in the balance. Good Luck.

G. Ilovewar

G. ILOVEWAR LGEN, USMC

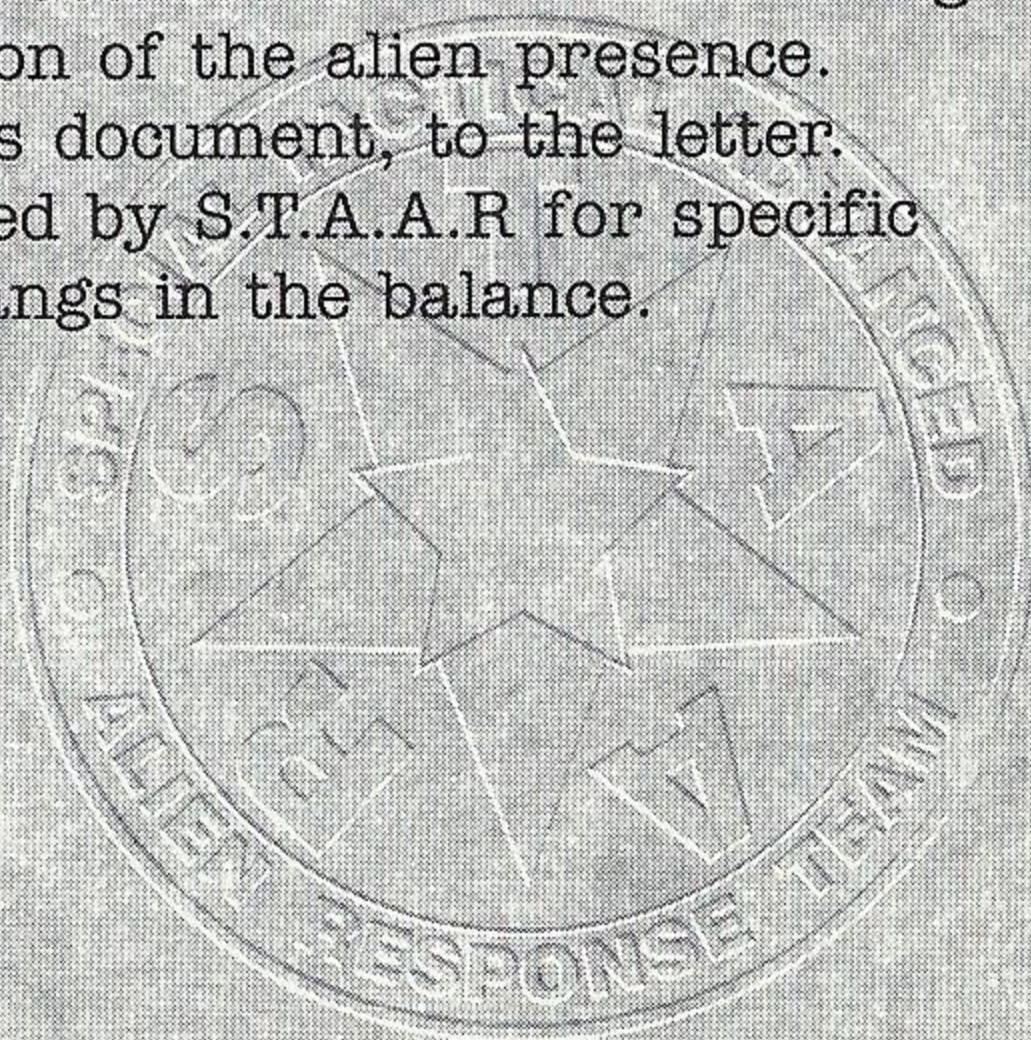

YOUR MISSION

Your gear is strapped on, your gun is loaded and now you're ready to clean house. As soldiers in the Strategic Tactical Advanced Alien Response (S.T.A.A.R) Team, you have been trained to deal with this exact situation. Your assignment is to penetrate the security of the air base and eliminate all threat of the deadly alien infection that has spread throughout the base. You can't trust any base personnel.

You must assume that all of them have been exposed to alien infection. The personnel may act in a hostile manner, and may mobilize the base's resources against you.

S.T.A.A.R Command has already sent extra supplies that you will need to the base. These have been air-dropped in, and can be found scattered through the base along the route you will be taking. As you infiltrate the base, you'll move through various hangers, rooms and areas outside. Shoot anything that moves, but be careful not to hit other S.T.A.A.R Team members.

TOP SECRET

GETTING STARTED

- 1 Make sure the power switch is OFF and there is no CD in the Sega Saturn System.
- 2 Open the unit, and insert the *Area 51* CD gently in the Sega Saturn System, close the cover and turn the system On.

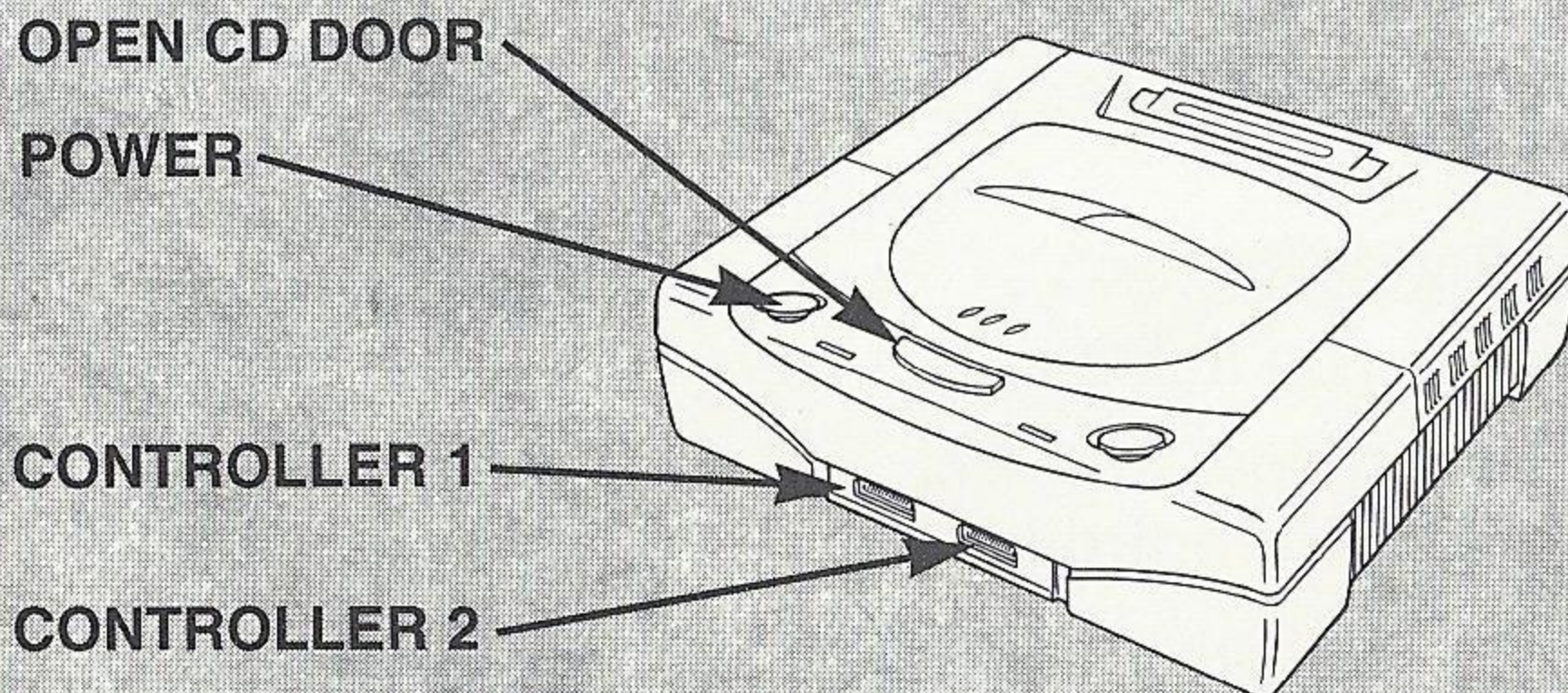

CONTROLS

SEGA CONTROLLER

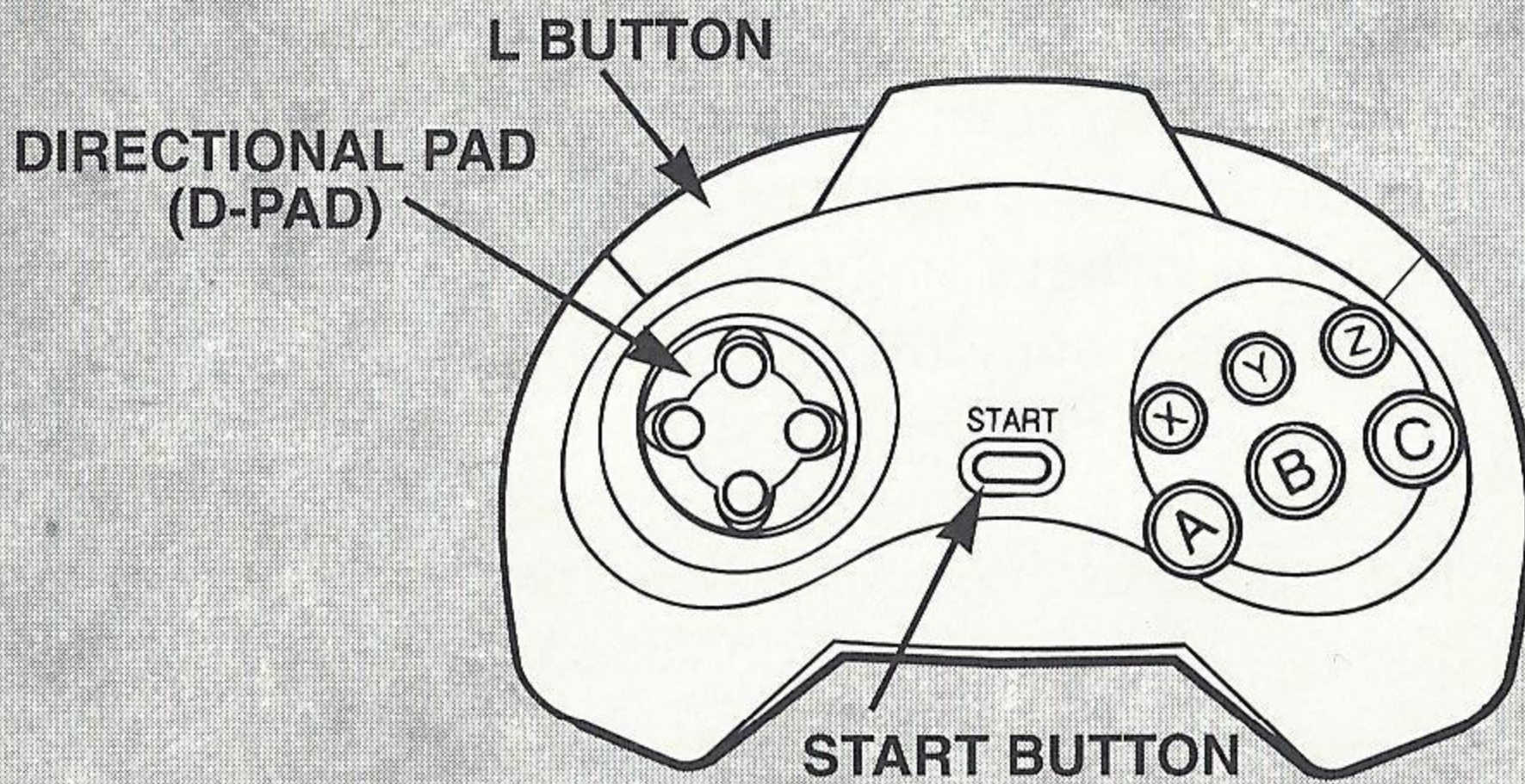

- Move crosshair over target: **D Pad UP, DOWN, LEFT or RIGHT**
- Pause/Resume Play: **START Button**
- Throw a Grenade: **Button A**
- Reload your gun: **Button B**
- Fire at the target: **Button C**

Note: You can modify the controls for the Control Pad (see **Player Select**, pg. 7, for details).

ARCADE GUN

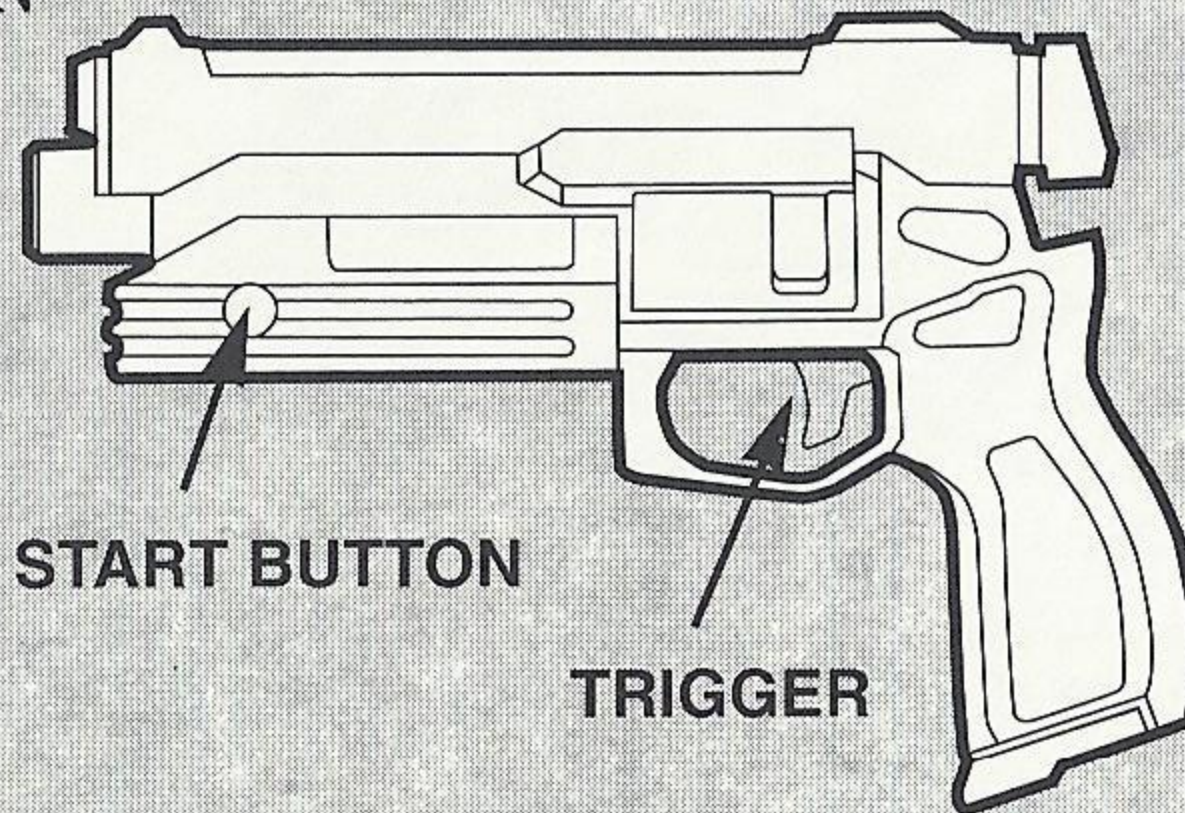

- **Pause/Resume play:** Press the **START Button**
- **Throw Grenade:** Fire at grenade displayed on-screen
- **Reload your gun:** Point the gun away from the screen, then pull the trigger
- **Fire at the Target:** Pull trigger

MENU SELECTIONS

(a) Using your gun:

Aim the gun at the option you want to highlight it.

Pull the trigger to select

(b) Using your Controller:

D-Pad Up/Down/Left/Right to move highlight

Press the **START Button** to select options

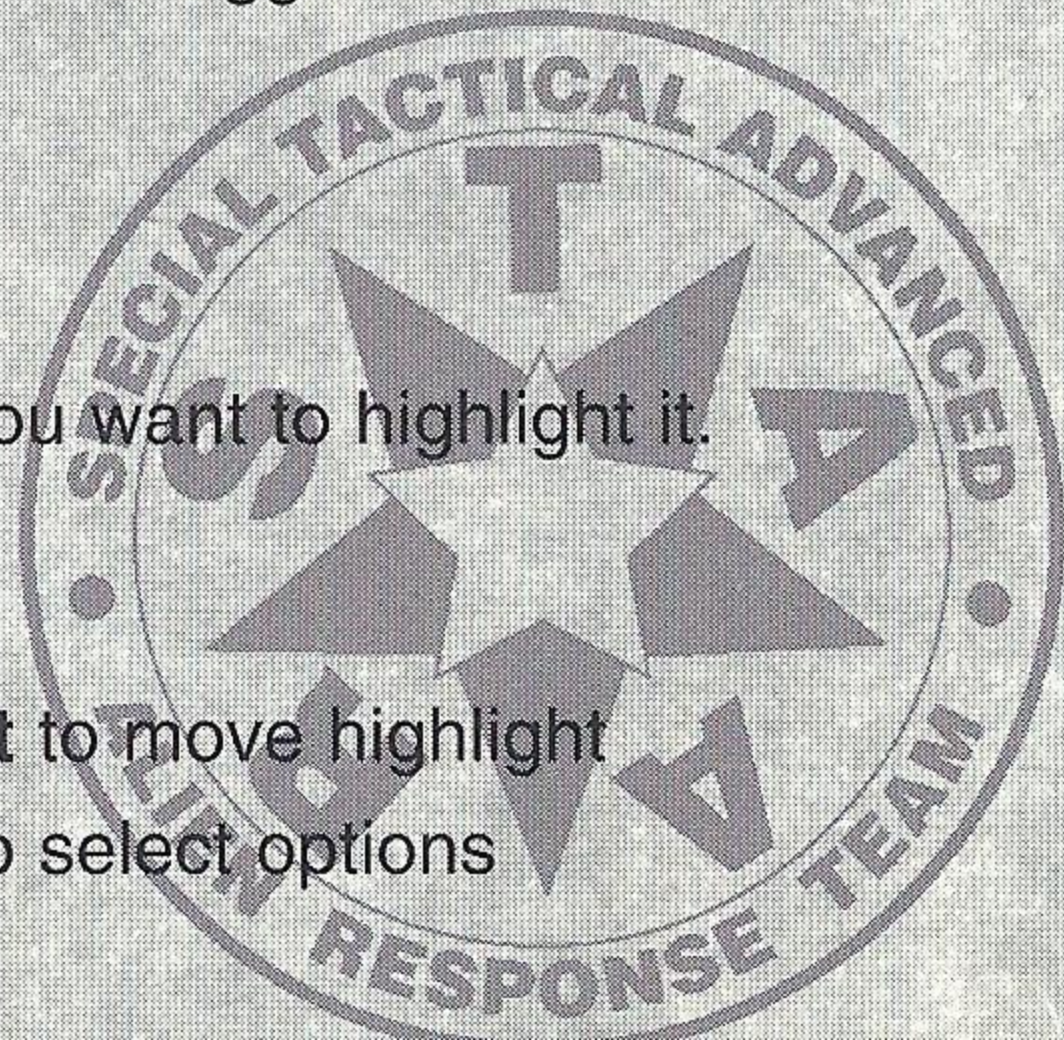

MAIN MENU

From the opening sequences and Title Screen, press **START** to display the Main Menu. Select from the following options:

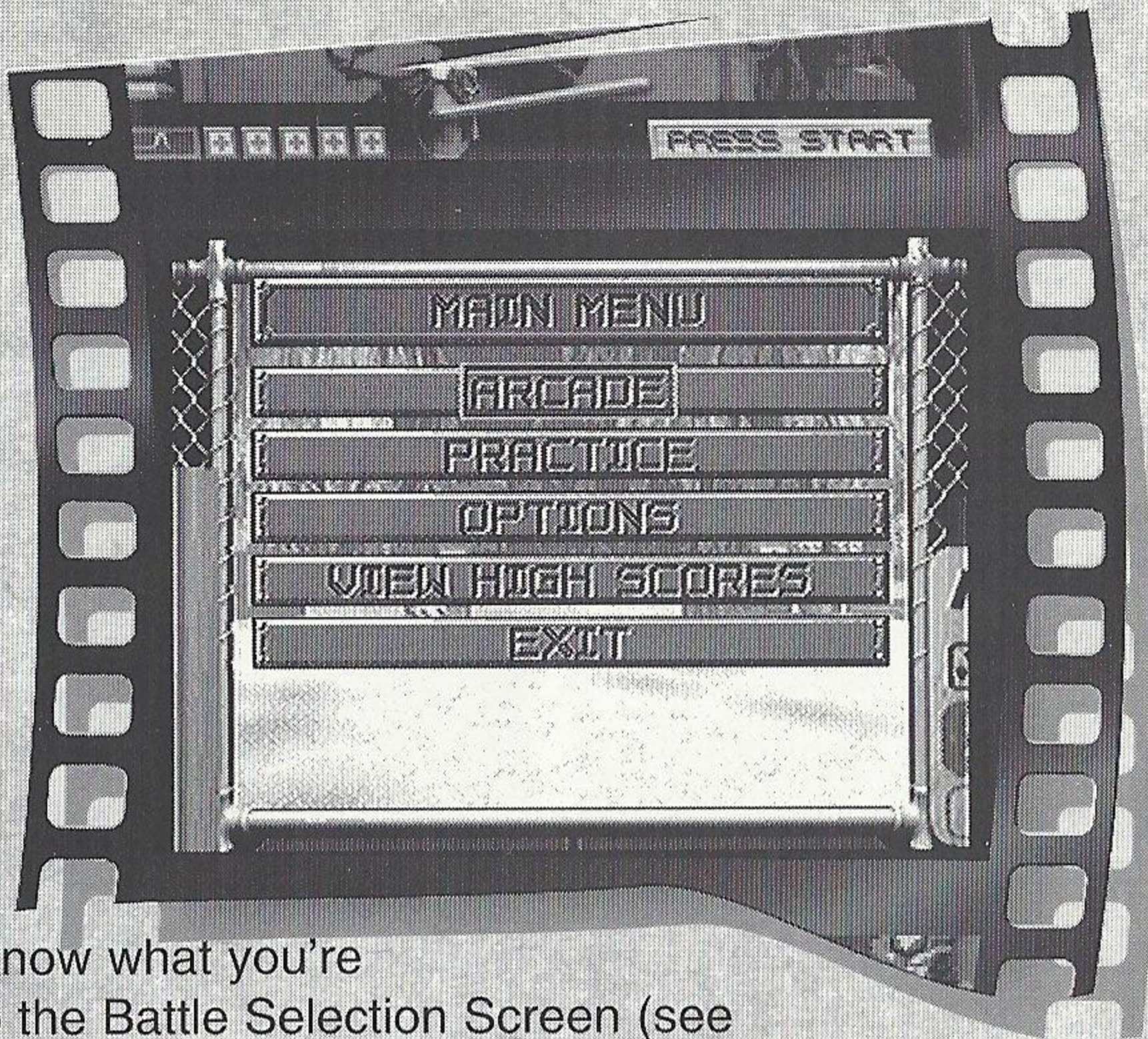

ARCADE

This is it. Throw yourself right into the action. Good luck. I hope you know what you're doing. You'll go to the Battle Selection Screen (see **Battle Selection** pg. 6).

PRACTICE

Before you attempt to blindly save the planet, you'll need some training. Select this option to prepare yourself for your suicide mission. Aim and fire at the targets to get used to your weapon's accuracy.

OPTIONS

You DO have some options that MAY give you a chance against the Kronomorphs. Make this selection to view them (see pg. 6).

VIEW HIGH SCORES

Select this option to view the names and accomplishments of the men and women that performed the best in battle against the enemy.

EXIT

This option exits the MAIN MENU and lets you view the file footage demo at Area 51.

BATTLE SELECTION

You have two choices: You can begin the mission at the **Beginning** or **Warp Ahead** to get right in the thick of the Alien forces. When you make your choice, aim the gun to highlight the selection, then pull the trigger. Get ready, you'll be dropped right into some heavy gunfire. We'd wish you good luck, but unfortunately you'll need more than that.

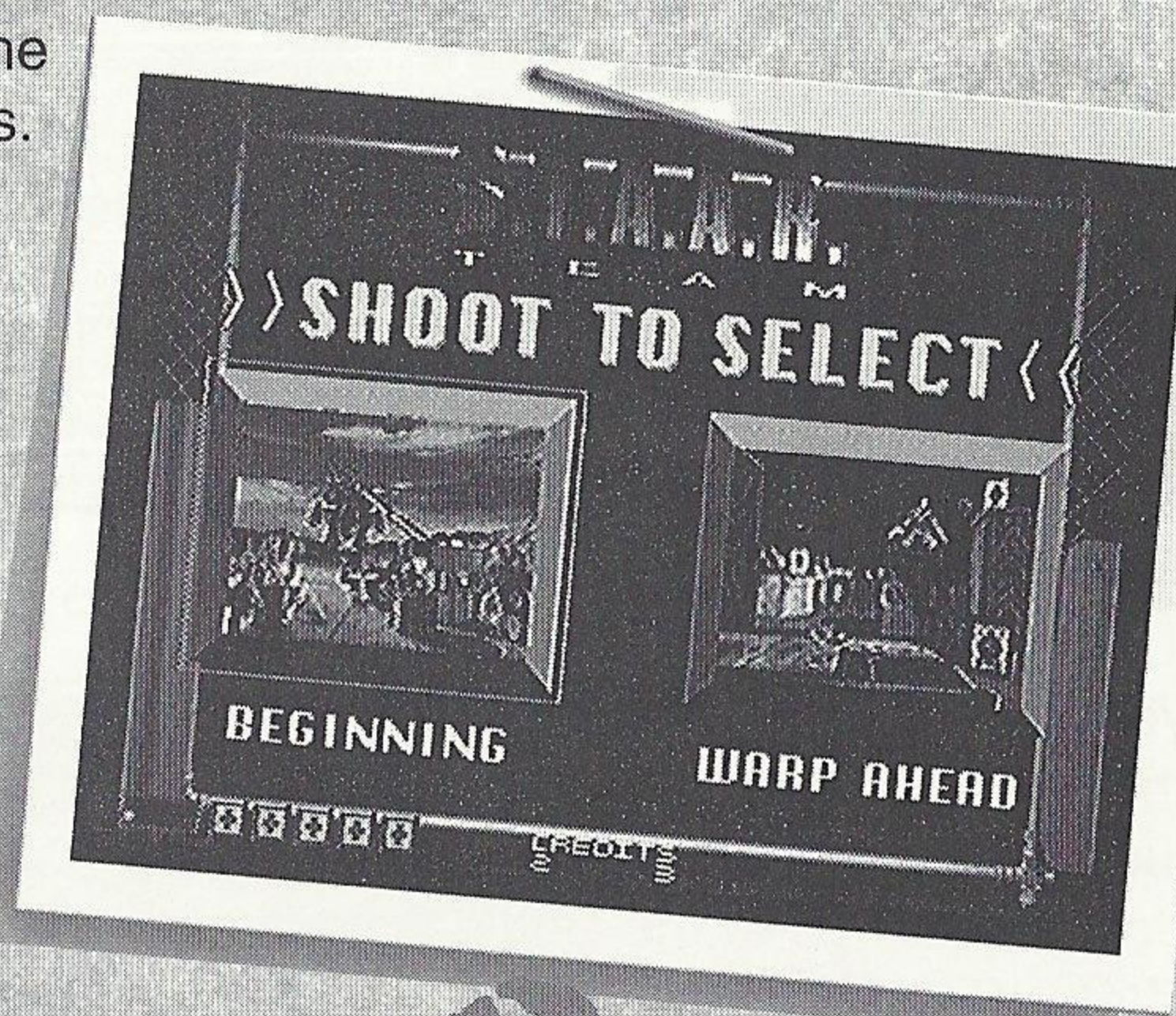

OPTIONS

The following options will let you carefully plan your attack on the military base. Study each option and make the changes that best suit your ability. In most cases you will be sent to succeeding pages to effect your changes.

PLAYER SELECT

Attempt this mission on your own or have a buddy join you. (see page 7).

SOUND OPTIONS

You can modify the sound configuration for the game. (See page 9).

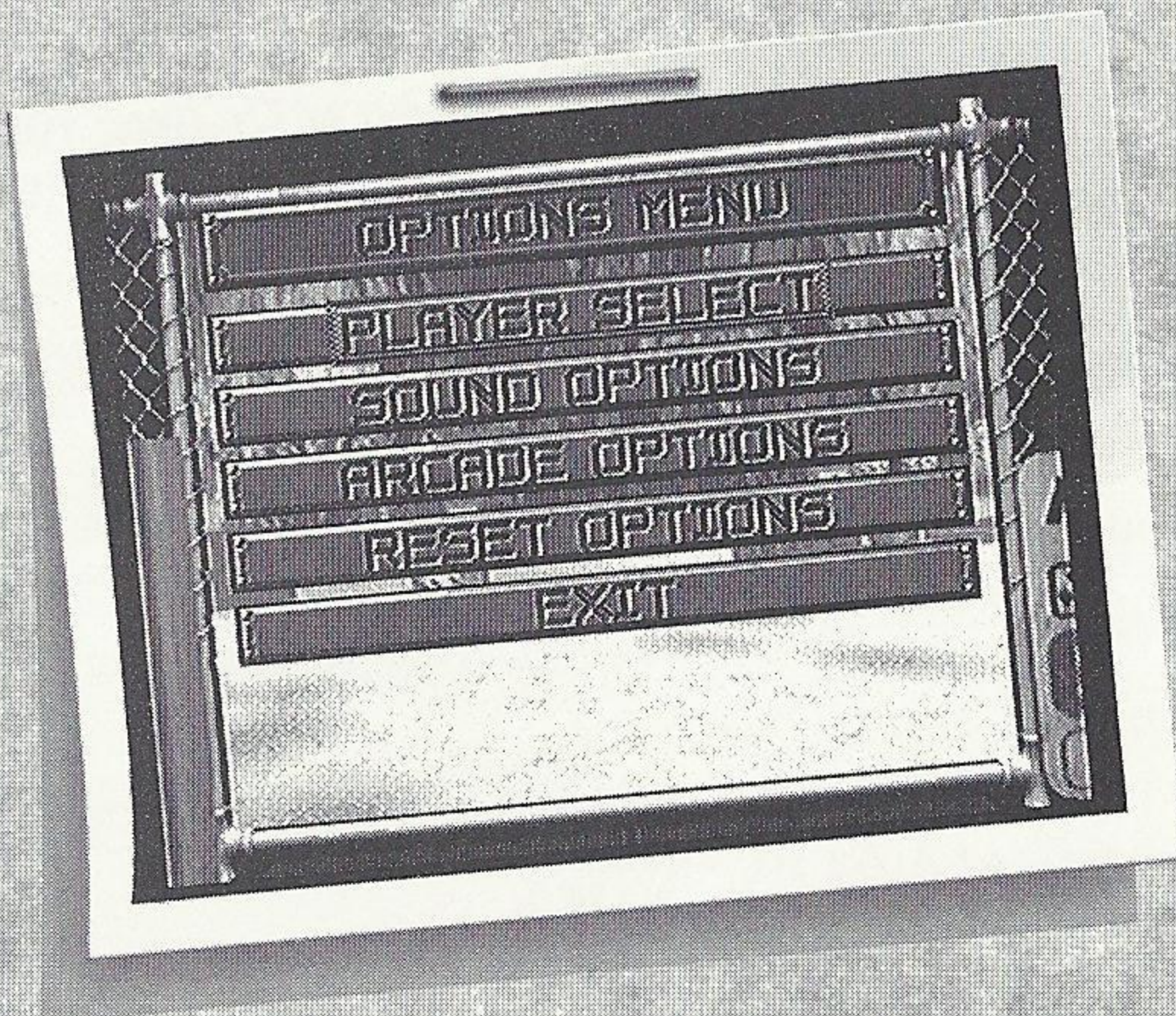

OPTIONS

ARCADE OPTIONS

(See page 9)

RESET OPTIONS

Click here to reset your ARCADE OPTIONS to their defaults.

EXIT

Select EXIT to get back to the MAIN MENU.

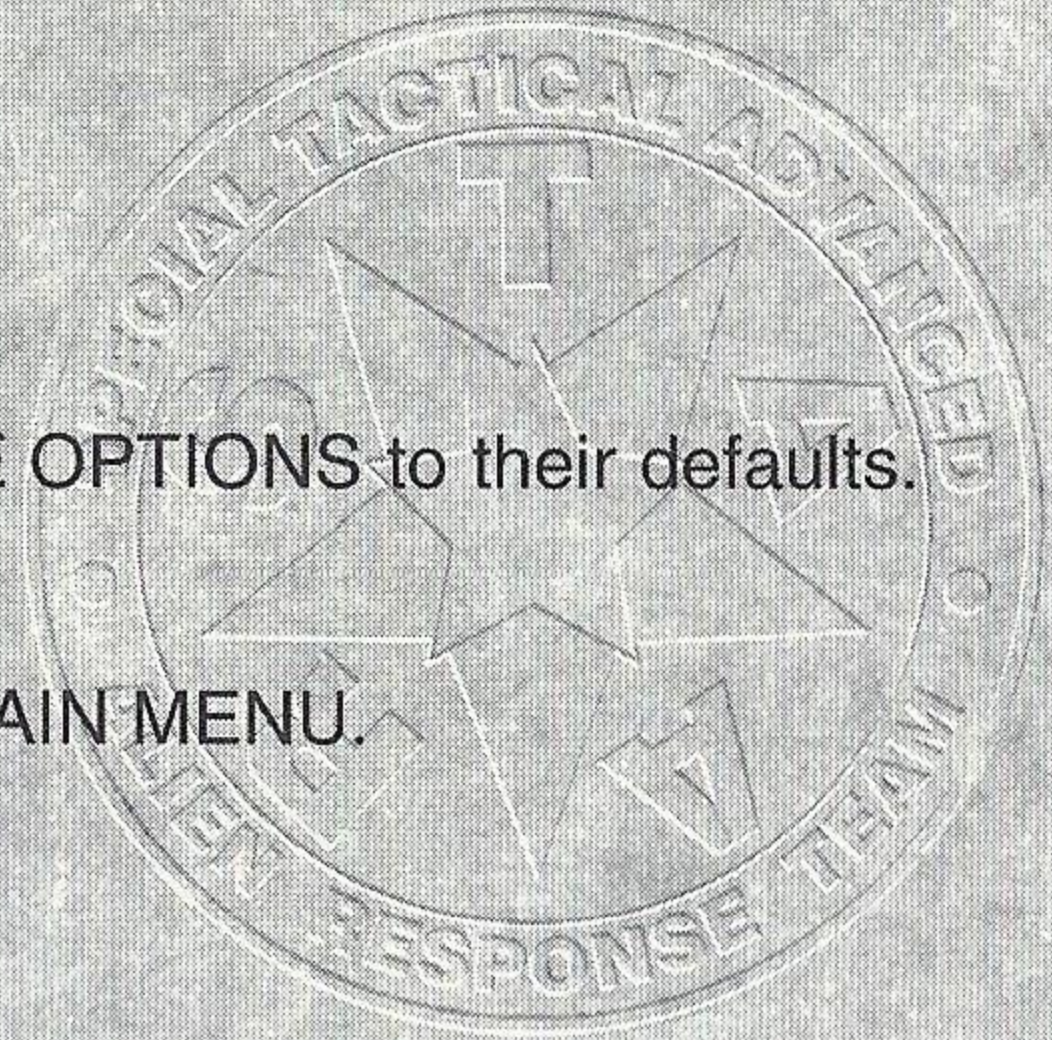

PLAYER SELECT

You can go it alone, or have someone back you up, thereby joining you in almost certain death. Here are your choices:

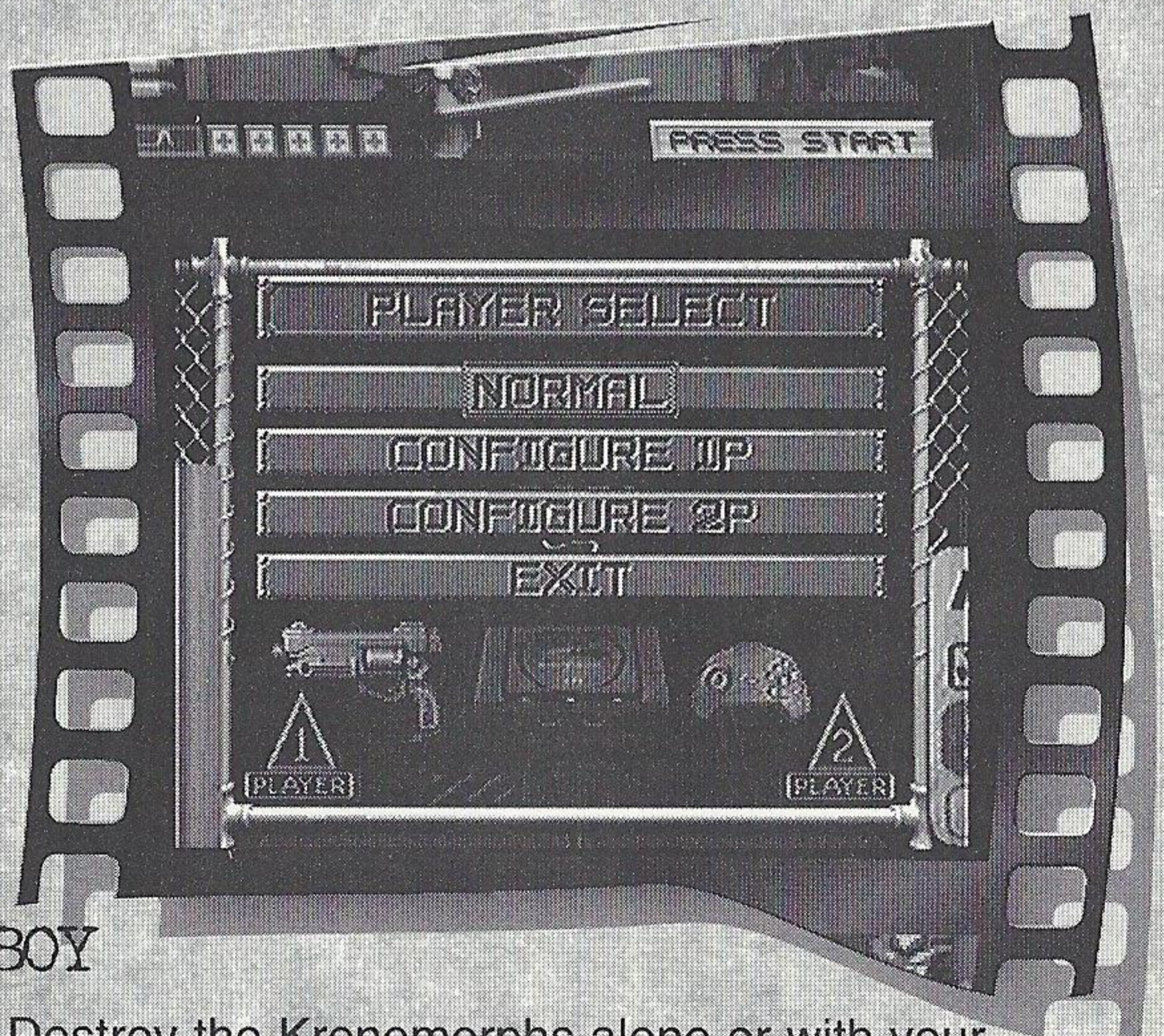

NORMAL/COWBOY

In Normal mode, Destroy the Kronomorphs alone or with your buddy. Or choose Cowboy, which is a one player mode that lets you do twice as much damage with a gun in both hands.

CONFIGURE P1/P2

Select this option to configure your gun or Controller the way you want. The configuration screen will change based on whether you use the gun or controller.

For example: If your gun is in controller port 1, select **Configure P1** to view the Configure Gun Screen.

TOP SECRET

PLAYER SELECT

CONFIGURE GUN

Follow these steps to calibrate your gun:

1 Press **START** to cycle through the gun configuration options and highlight **Test**. Aim and fire at the alien in the target screen. Bullet holes will appear as you shoot. Make sure the bullets are hitting your target. You don't want your weapon to jam in the face of your enemy.

2 If the bullet holes appear where you're aiming, you won't need to calibrate the gun.

Select **Exit** to return to the Player Select Menu.

If they are not hitting your target, go to Step 3.

3 Select **Calibrate** from the menu. A red light will flash within the target area. Aim at the target, then pull the trigger to calibrate it.

4 Follow Step 1 to test your aim again. Select **Reset** to erase your calibration, and repeat the entire process if necessary.

5 Select **Default** to return to the games default setting.

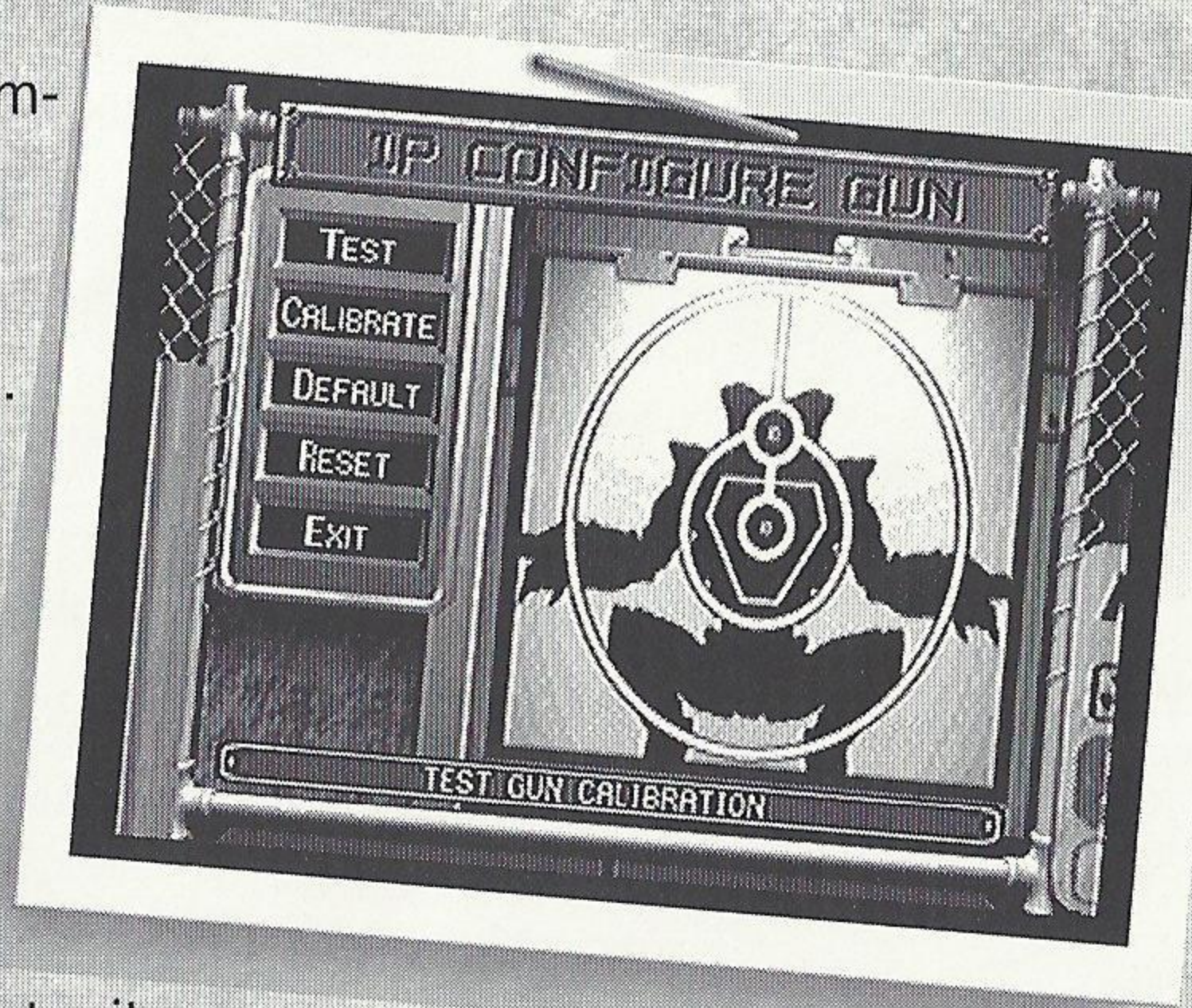

CONFIGURE JOYPAD

To configure your controller the way

you want, press any button (other than **START**) to cycle the different configurations. The screen will display the new action, and assign it to a new button. When you find the configuration you like, highlight **Exit** and press **START**.

Select **Cancel** to disregard any changes you've made and return to the

Player Select Screen. Select **Default** to reset any changes you've made to the original settings. When you've finished making any changes, highlight **Exit** and press **START**.

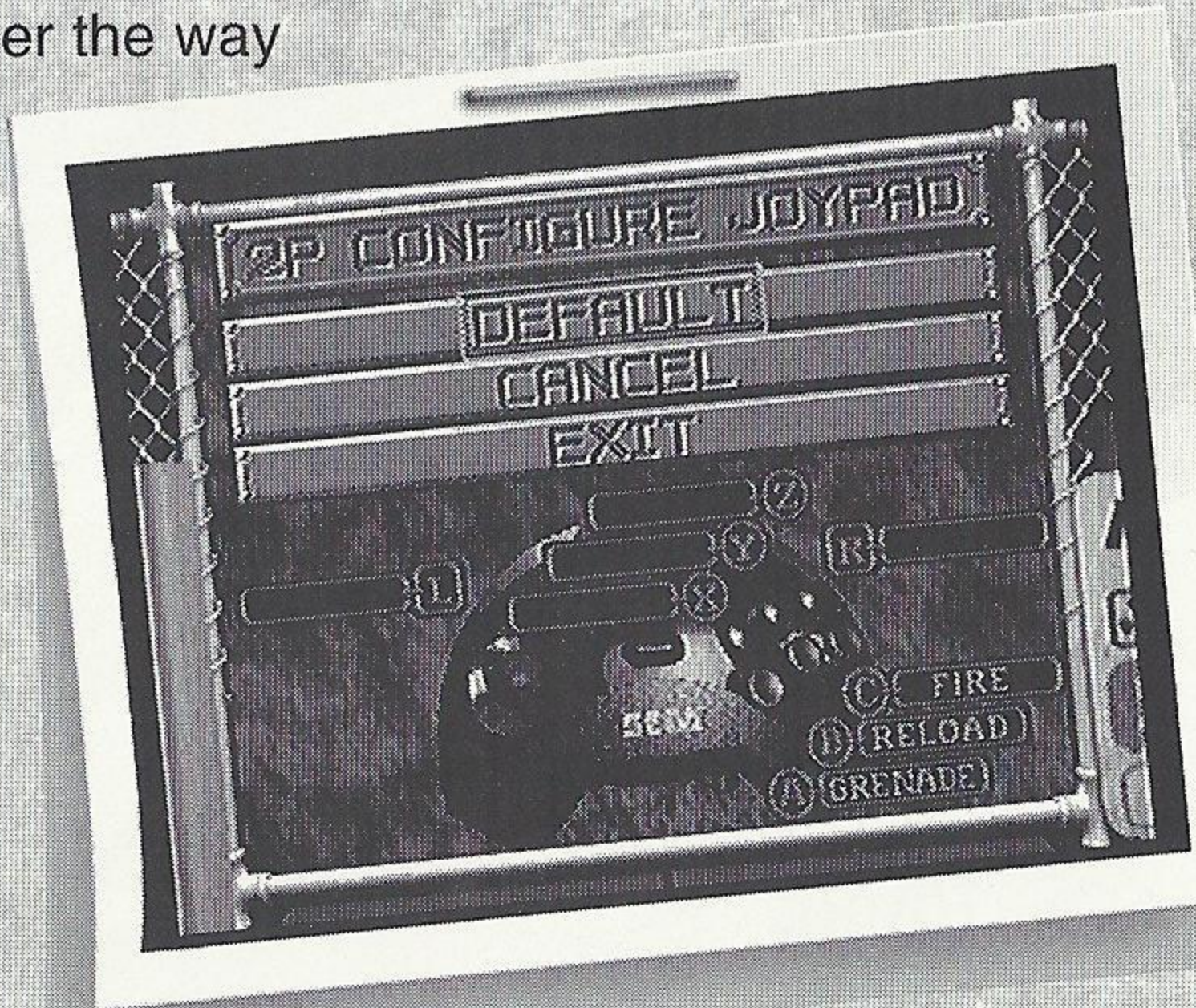

PLAYER SELECT

SOUND OPTIONS

You can modify the sound configuration for the game. Select the **STEREO/ MONO** option to toggle between the two settings. You can also set the **EFFECTS** and **MUSIC** volumes the way you want. Select **EXIT** to accept the changes and return to the Options Screen.

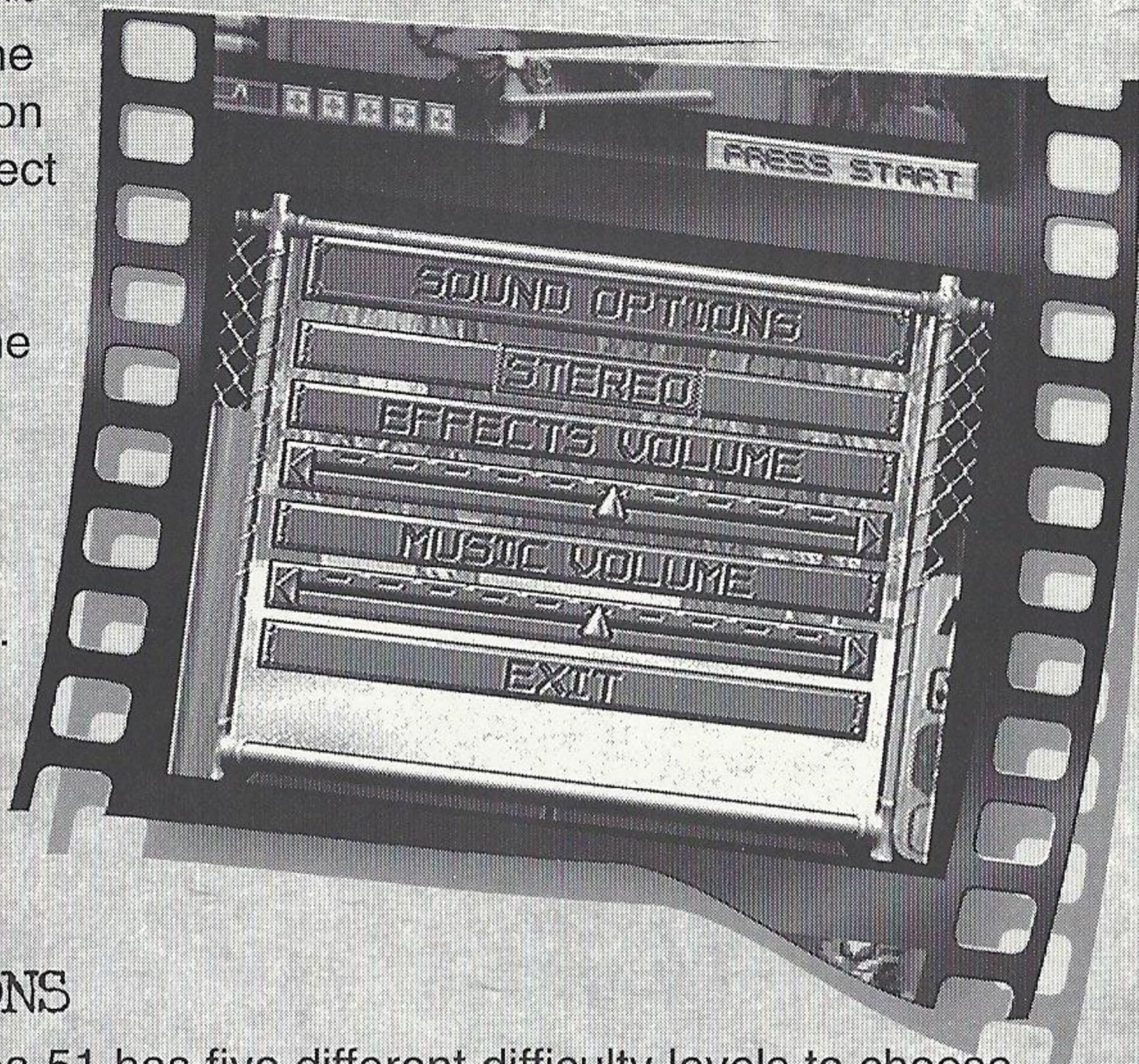

ARCADE OPTIONS

DIFFICULTY--Area 51 has five different difficulty levels to choose from. Select from **Novice**, **Easy**, **Medium** (default), **Hard** and **Expert**.

LIVES--Set the amount of Lives you can have to make things really difficult. Select from **3** to **5** lives. You'll continue to play until all of your lives are gone.

CREDITS--When you run out of Lives, the game will stop. You'll be prompted to Continue the game. If you have credits left, press **START** to continue the game. Select from **1** to **5** credits to extend your game. When you're out of credits, the game ends.

GAME LOOPING--Set this option to **On**, and the game will loop to the beginning, once you've completed the entire game. Your accumulated points, weapons and ranking will carry over. Select **Off** to have the game end when you've saved the world.

SECRET ROOMS--Turn this option to **Off** to play the game without entering any Secret Rooms. Default is **On**.

GORE --Turn this option **Off** for no blood. Default is **On**.

EXIT--Select to return to the **OPTIONS** menu.

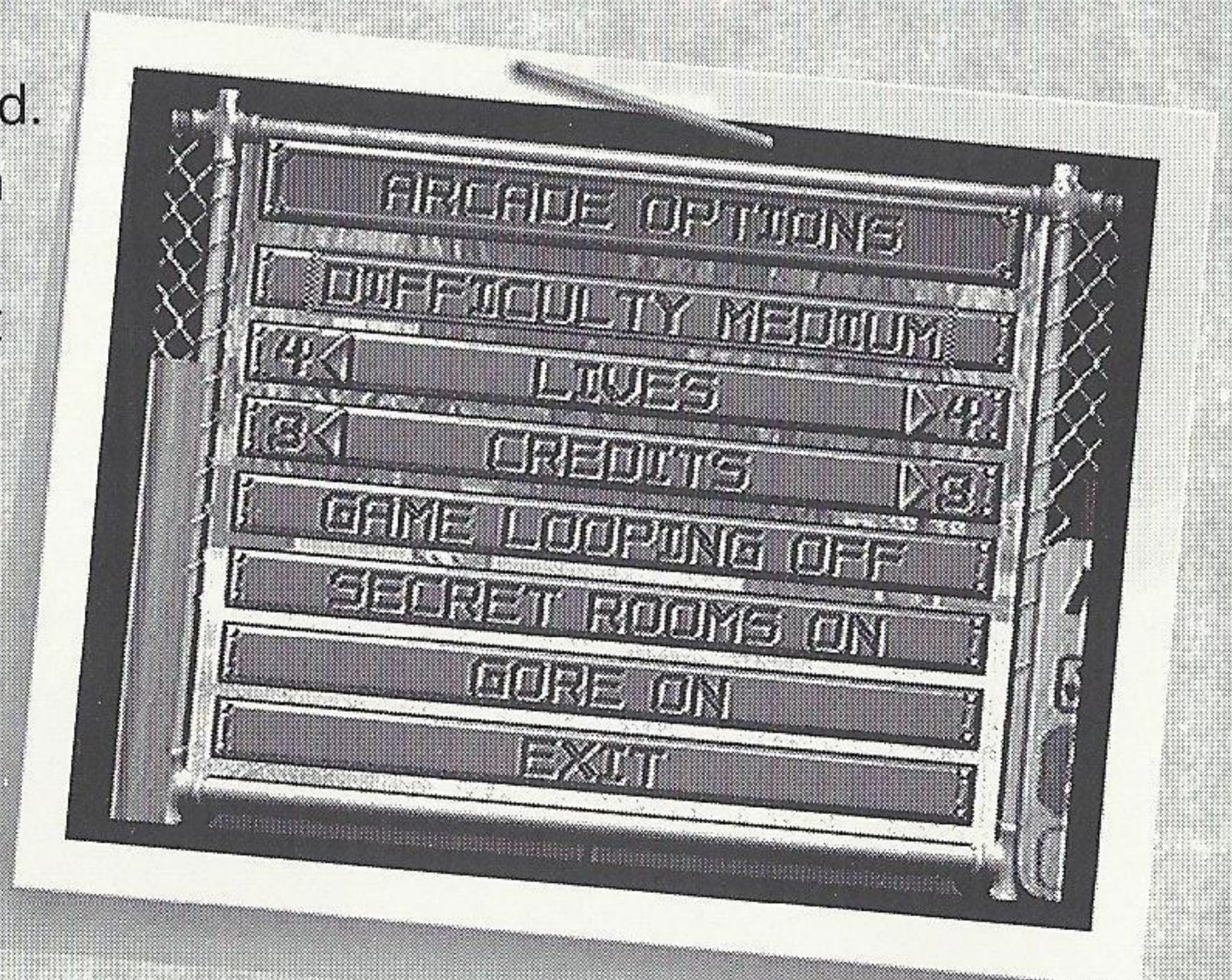

MISSION OBJECTIVES

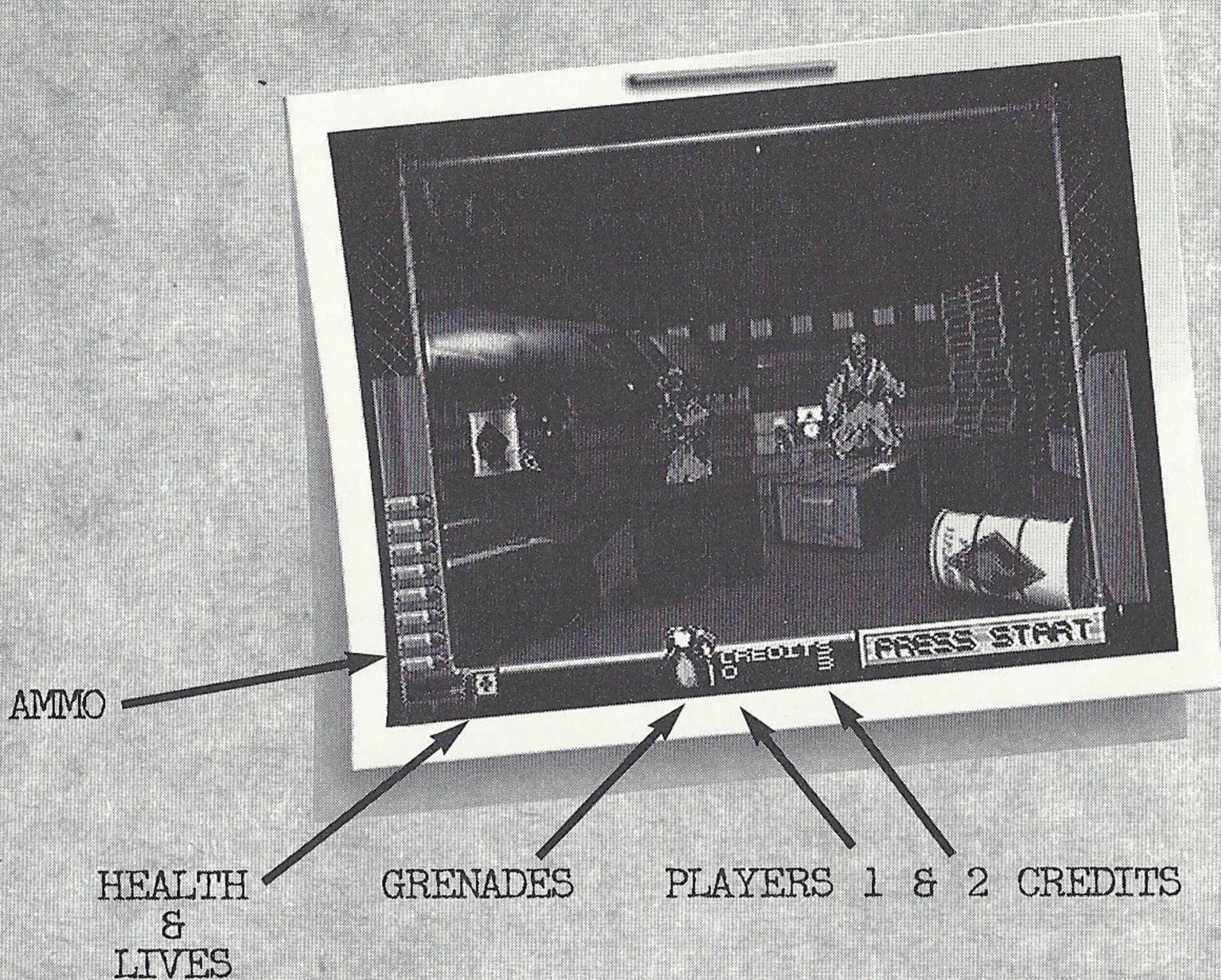

THE TERRAIN

As you scramble for your life inside the base, you'll have a constant view of the base, your Ammunition, Health and Grenades. The amount of Credits for you and your partner are also displayed.

AMMUNITION

You are issued the standard ammunition for the mission, but you can accumulate two other types of rounds. Shoot every Power Up (see **Power Ups**, pg. 12) you see to accumulate these other types of rounds:

MACHINE GUN SHELLS - When you pick these up, hold the trigger down and watch the aliens go down. Be aware, though, your ammo will go fast. Reload as often as possible.

SHOTGUN SHELLS - These are powerful and great to have. The downside is the amount of rounds per clip. Reload as often as possible. If you hit another Power Up while you're using these, you'll fire automatic rounds if you hold down the trigger.

Note: These two types of ammunition are limited in quantity. Be aware that they will run out, and you'll have to use your standard rounds until you pick up more.

MISSION OBJECTIVES

TOP SECRET

HEALTH AND LIVES

Your heart rate is always monitored. The faster your heart rate, the closer you are to "checking out". Stay low and shoot them before they shoot you. The amount of Med Kits displayed represent the amount of direct bullet hits you can take. You can adjust this amount (see **Lives**, pg. 9).

GRENADES

Shoot any Ammo Crates (see **Ammo Crates**, pg. 12) you see to possibly find grenades. These come in handy when an area gets too hot. If you find yourself surrounded, shoot the grenade. It will take out anything around you, except those ugly Purple Kronomorphs. You've got to plug them full of holes before they go down. The amount of grenades on your person is displayed on the grenade graphic.

CREDITS

The amount of credits remaining in your mission is displayed for you and your partner. You can modify this amount.
(see **CREDITS**, pg. 9)

SECRET ROOMS

Area 51 has many of these rooms. Unfortunately, there's no information available at this time regarding locations and how many. We strongly suggest that you shoot everything in sight. The rooms will present themselves if you've hit the right combination of targets.

CLASSIFIED



MISSION OBJECTIVES

PRIMARY TARGETS

The obvious targets are the Kronomorphs and Zombies, but you are under orders to shoot many other items. Study these items carefully before you begin:

POWER UPS

You'll find these hovering in the air as you move throughout the base. Shoot them to acquire larger, more powerful ammunition. When you hit a Power Up, your ammunition will change to a Shotgun or Machine Gun rounds. You can achieve an automatic Shotgun by hitting a Power Up while you still have remaining Shotgun Shells.



BARRELS

Yellow barrels are scattered throughout the base. These are favorite hiding places for the Zombies, so shoot as many as you can. They explode and take out anything in proximity. Destroying them adds to your Streak (see **Streaks**, pg.14) performance and may also unlock secret rooms.

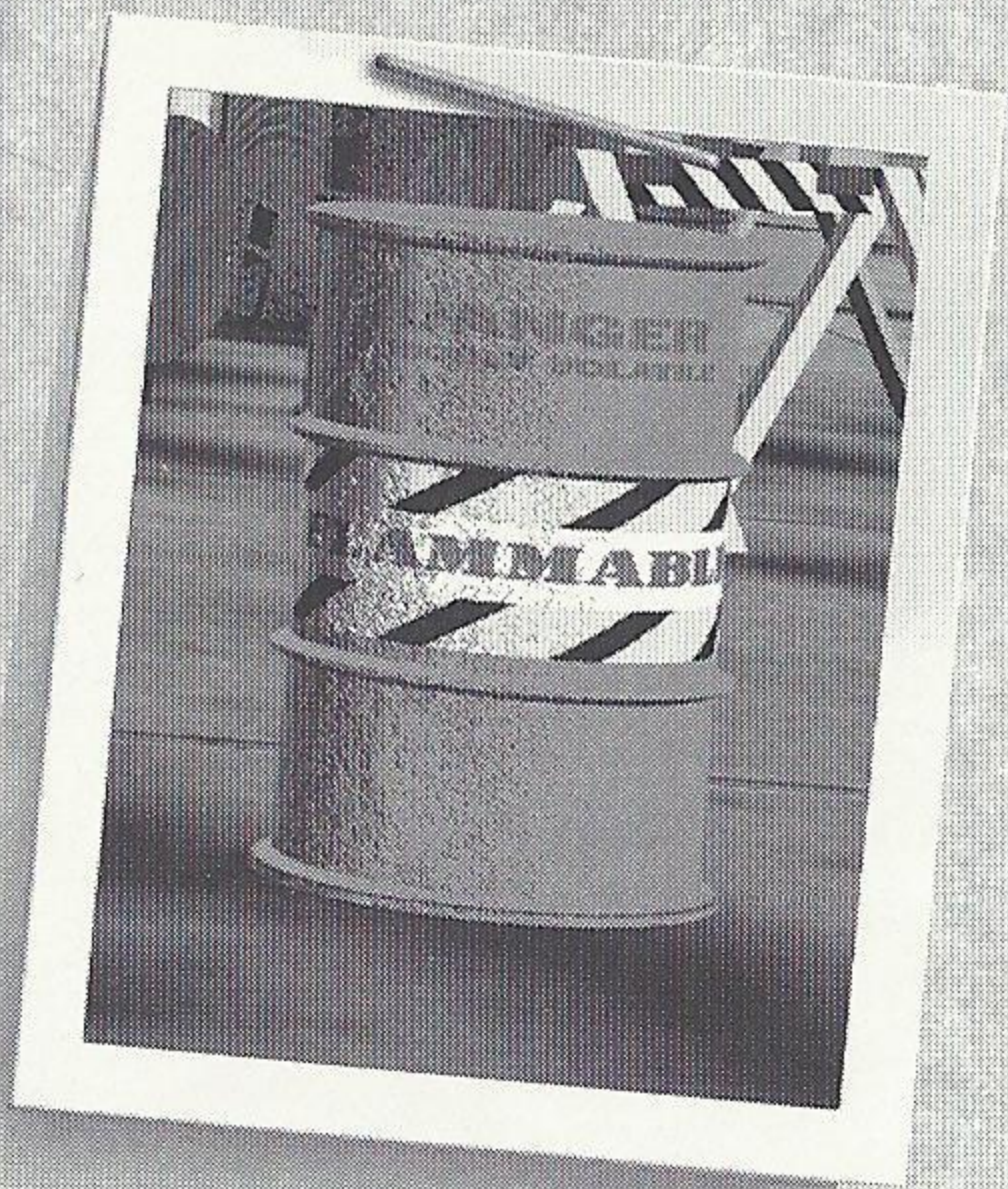

AMMO CRATES

Locked ammunition crates are found all over the base. Shoot them open to recover grenades or extended ammo clips. The clips come in handy when you don't have much time to reload.

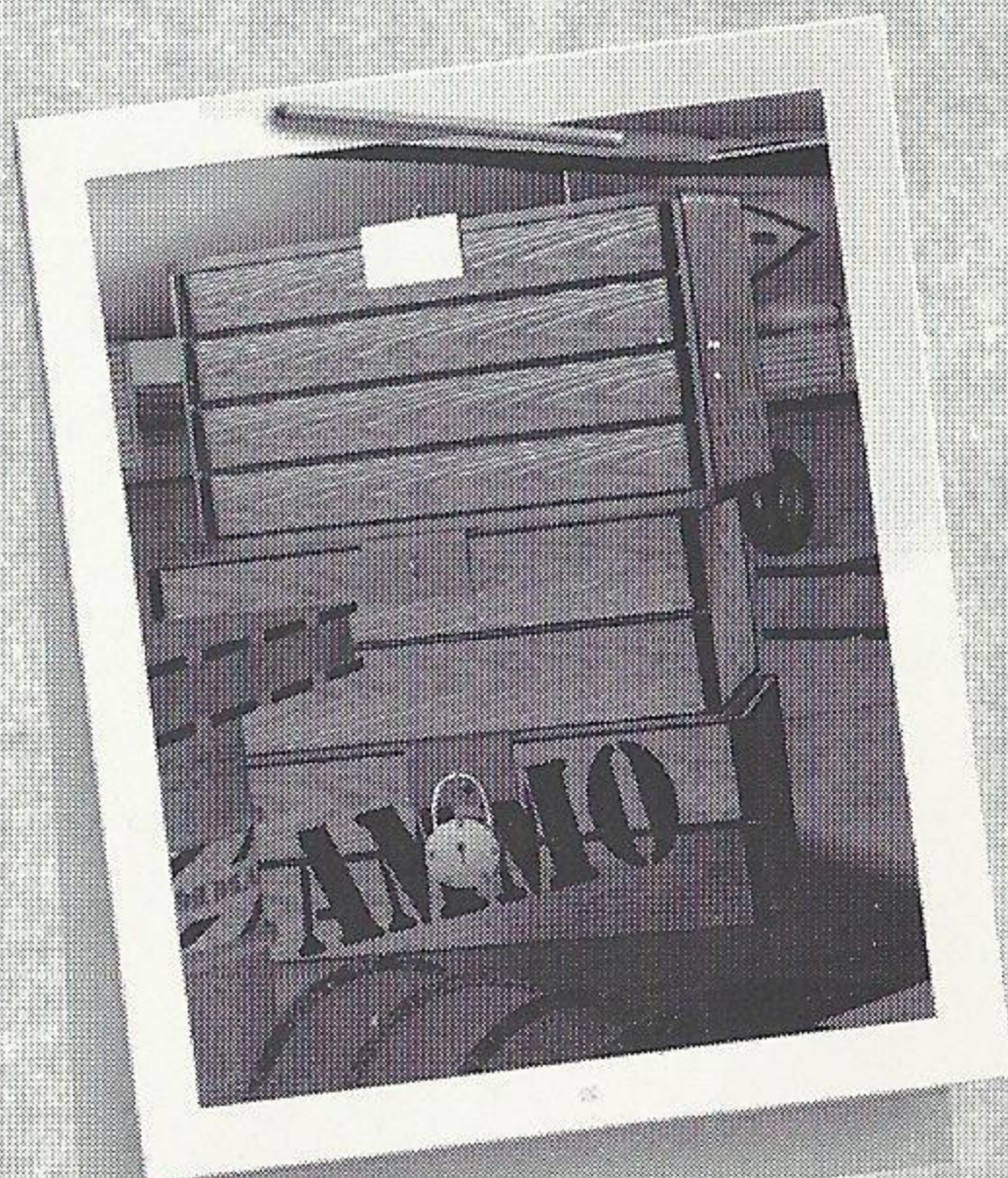

MISSION OBJECTIVES

WINDOWS

This is a simple order: See a window? Shoot it! Windows unlock secret rooms and add to your Streaks (see **Streaks**, pg. 14). Shoot windows in vehicles and in rooms.

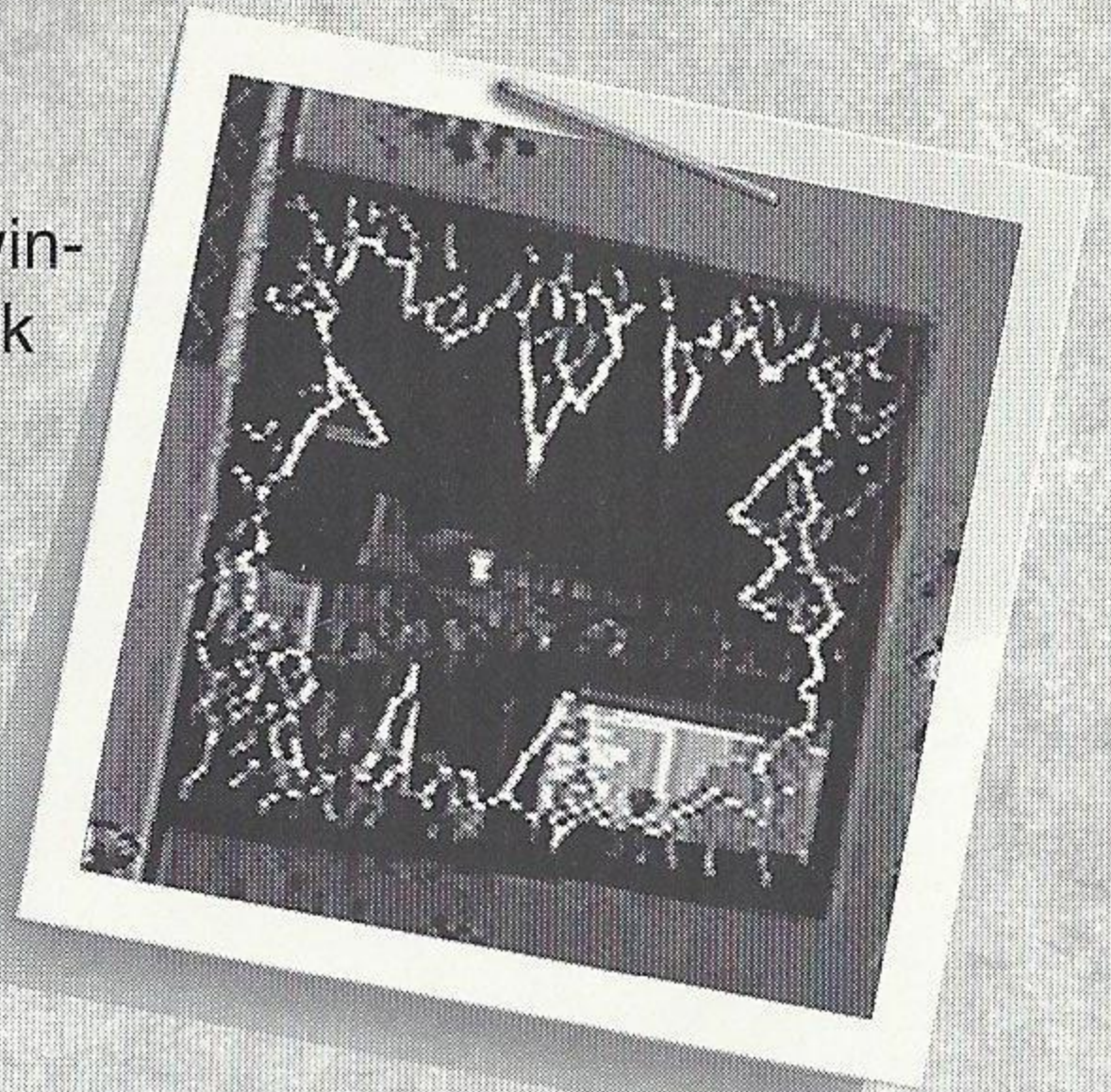

FIRE EXTINGUISHERS

Shoot Fire Extinguishers when you can. The force of the explosion will take out an alien close by. It will not, however, kill the purple Kronomorphs.

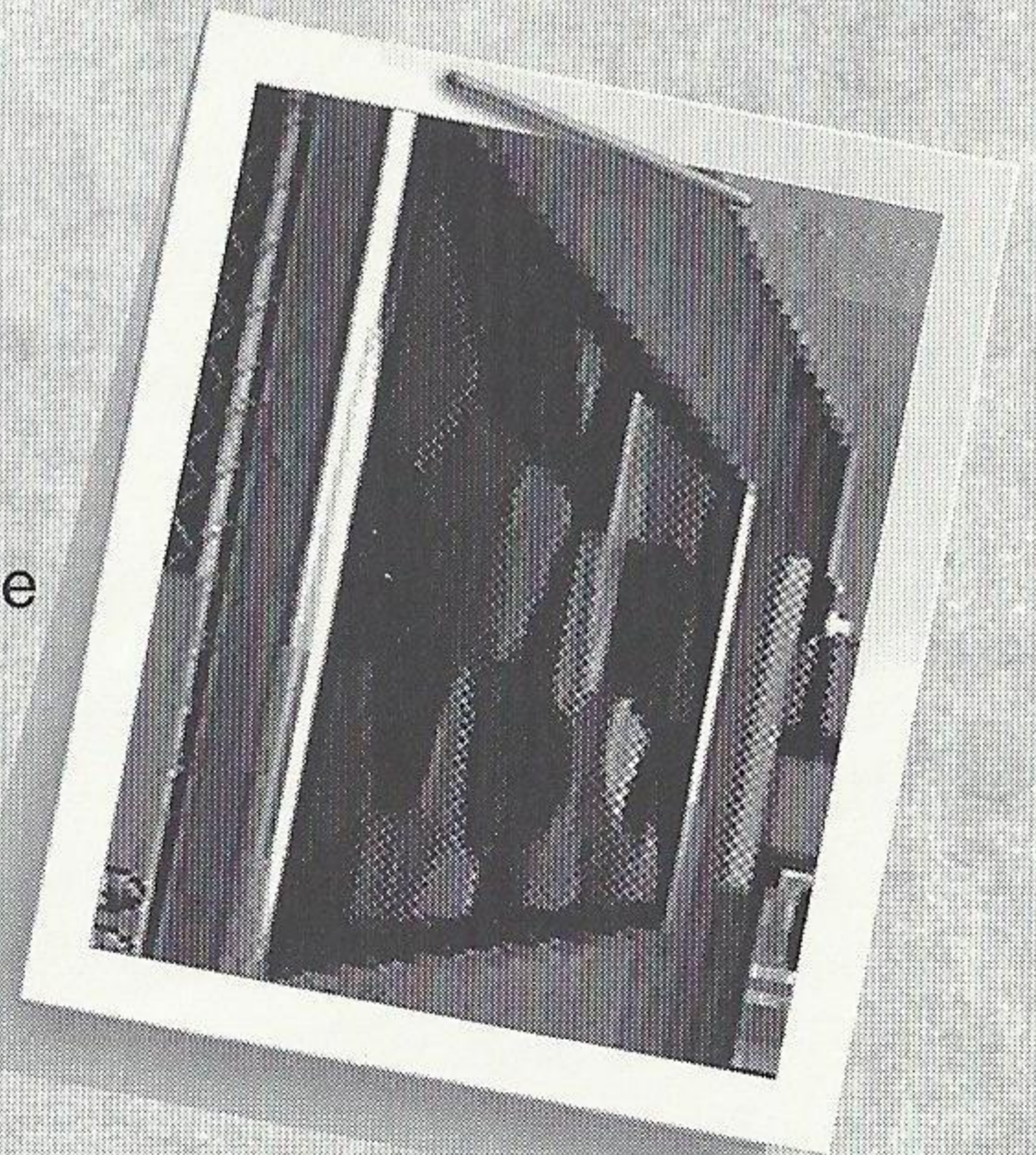

PAINTINGS

I know this sounds strange, but you are under orders to shoot the paintings, too. For some reason, they may give you grenades or access to secret rooms.

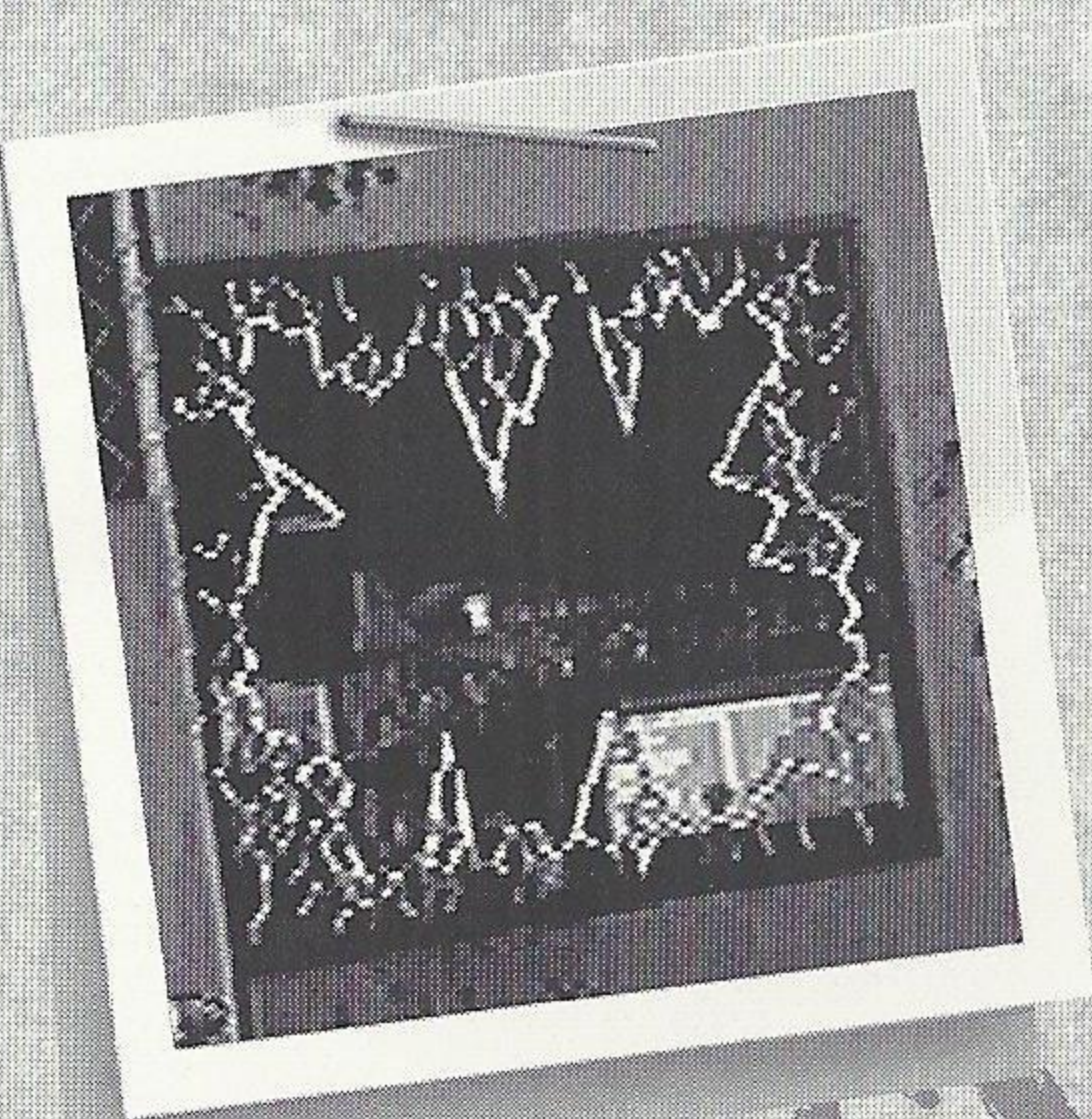

MACHINERY

Destroy all computer equipment and any other items on desks and tabletops. We need to cut off their contact to the outside world.

MISSION STATUS REPORTS

After each stage of the mission, a Status Report will be given. It lets you know the following information:

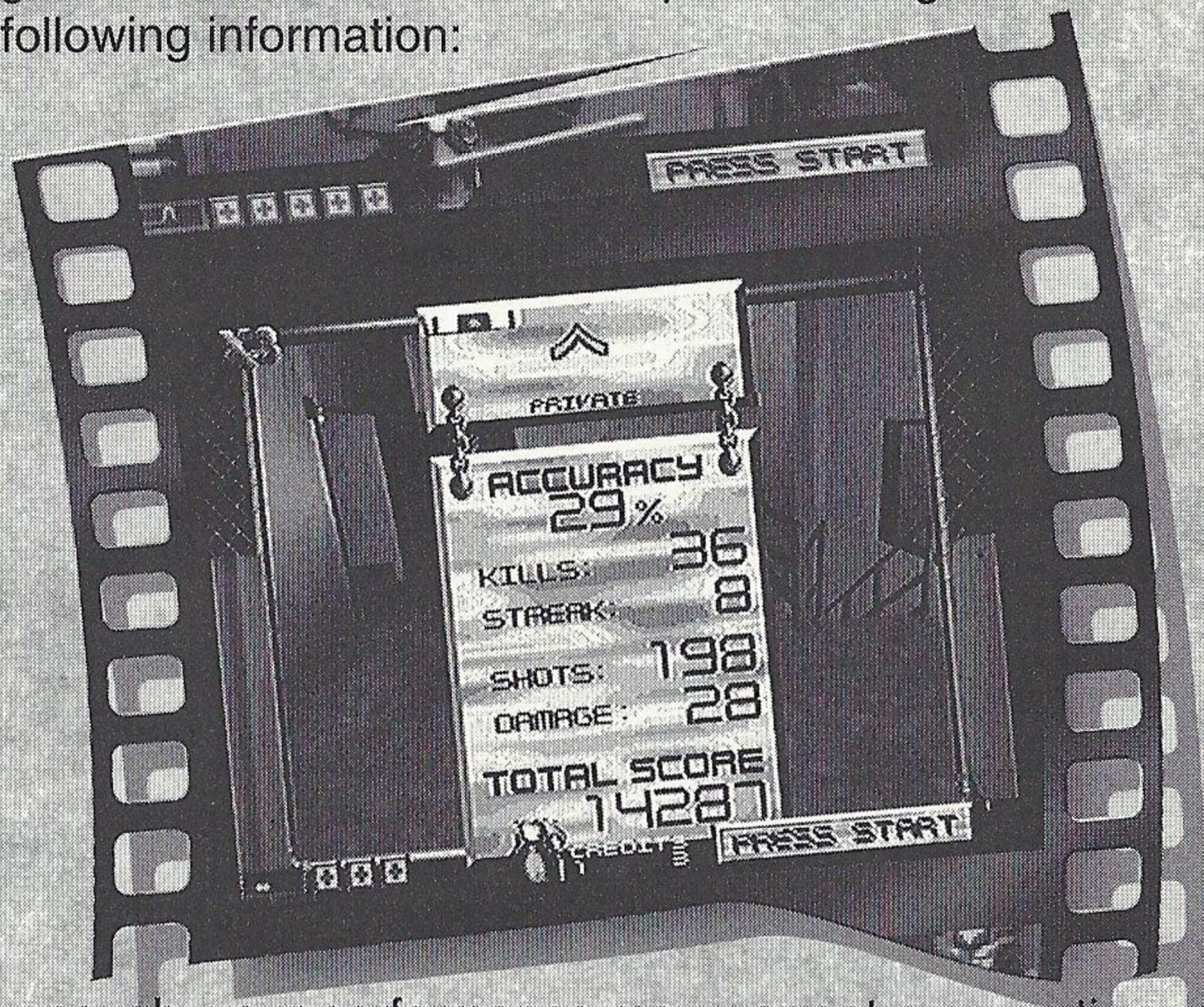

RANK

If you live long enough, your performance may warrant a promotion. Do your job, and you may walk away from this situation a General. You can keep track of any promotions by looking at your Mission Status Reports. Your rank will be displayed at the top of the report.

ACCURACY

The ratio of Shots Fired and Targets Hit is tallied during each stage. Your hit percentage is recorded.

KILLS

You better have a lot of these. Each time you make a Kill, it is counted on your report.

STREAK

As you shoot and destroy, you are rewarded for accuracy. When you hit your targets without a miss, the amount of targets you hit in row will be displayed. This skill is taken into account when your Rank is determined.

SHOTS

The amount of shots fired is accumulated during battle. Keep your Shot count down and your Kill count up to receive the highest points toward a promotion.

DAMAGE

This number represents the objects you've destroyed. The more barrels, crates, windows, etc. you shot, the higher the number.

TOTAL SCORE

Your cumulative points for any completed stages is given.

TOP SECRET

THE S.T.A.A.R TEAM

A brief history: formed in 1958 at the height of the Cold War, the creation of the *Special Tactical Advanced Alien Response* (S.T.A.A.R) was a direct response to the threat of armed alien invasion. In the years after World War II, as US and USSR pilots continuously set new high altitude and performance records, an increasing number of strange aircraft sightings were reported near the boundary of Earth's stratosphere. Most of these were written off to the extreme effects of high-altitude navigation, which can cause hallucinations and "gray-outs," often causing pilots to see light. Some of these pilots, though, were adamant in their belief that there was something else "out there" in space, watching us.



A S.T.A.A.R Point Team has also been dispatched for the assault on Area 51. The team's soldiers wear bright blue and are clearly marked with "S.T.A.A.R" on their uniform. Do NOT slip up and shoot them. Friendly Fire costs Lives.

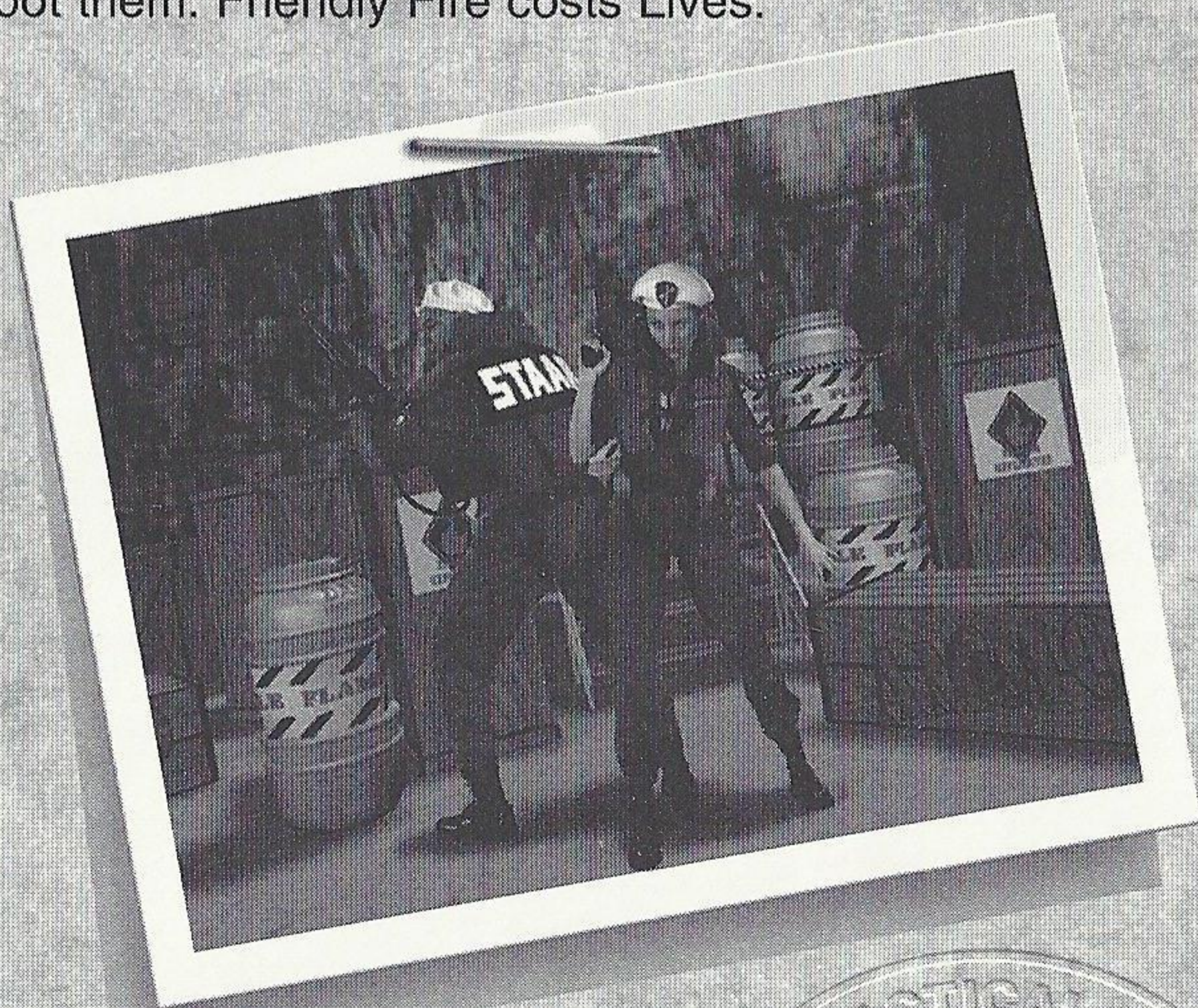

S.T.A.A.R. troops
wear blue uniforms
with white STAAR
labels on the back.
AVOID SHOOTING
THEM!



THE ENEMY

The Kronomorphs were designed to accept quickly and rapidly the latest "weapons" codes that the Kronn geneticists have developed. As a result, they are hot-beds for fast DNA assimilation and replication, accepting DNA into their systems and using the information in a matter of days or even hours. They are creatures that can adapt to their environment with rapid speed, adopting the best traits of the various species around them. Still, for all of their genetic abilities, the Kronn scientists have kept the Kronomorphs deliberately stupid, and they have remained that way, obeying the orders of their Kronn masters as if they were a strange combination of warrior and mind-controlled slave. Study these profiles very closely. You'll know these creatures when you see them, but you'll need to know this background information before going in.

ZOMBIE

Metamorphosis: Stage 1

Human flesh turns gray and begins rotting from the body, drooping into large folds. An alien larva begins growing within the body, roughly taking the shape of the human skeleton.



FIG. 5-1 Stage 1 aliens, code-named "Zombie". Appear generally humanoid.

UNKNOWN Metamorphosis: Stage 2

We have word-of-mouth reports about Stage 2, but no documentation or pictures. It is a short, very painful transitional stage where the alien literally explodes out of the incubating human sac.

Because of the rapid speed of genetic replication, the host body needs a large source of raw bioplasma, and at this stage the mutants must feed voraciously. In addition to being replicatory hosts, humans are also a source of food. Reports have come in about a room called the Chow Palace, where Stage 2 aliens may have been sighted. We can't confirm this information at this time.

THE ENEMY

KRONOMORPH

Metamorphosis: Stage 3

Stage 3 is the full blown alien stage. The alien is heavily armored and extremely fast, and can grow bioplasma weapons from its own flesh. These include a plasma based particle beam and hardened calcium carbonate projectiles.

The alien has one large eye in the center of its head, which can project light as well as scan terrain for heat patterns. Two smaller eyes in the middle of the head monitor our conventional light spectra. Aliens feed through a large mouth in the center of the chest, assisted and protected by six functional arms that fold over when not in use.

Reports have surfaced about purple Kronomorphs that can withstand multiple rounds of fire. Pump some lead into these guys, and they should go down.



TOP SECRET

Kronomorph, stage 3, the virulent evolved form. Quick and particularly lethal.

SAVING THE PLANET

We wish we had the answer to this one. We DO have a report (see attached message) that there is an Alien Space Craft somewhere on the base. We suggest you destroy all alien beings, then concentrate on destroying that ship; if it exists. You'll only have your guns to work with, so make every shot count.

OUTGOING CLASSIFIED MESSAGE

UNCLASS - ROUTINE - PRIORITY - URGENT	OFFICE OF ORIGIN	EXTENSION
PRECEDENCE URGENT	S.T.A.A.R.	120
DATE: 28 Aug, 1996		NAME OF OFFICER PREPARING LGEN G. ILOVEWAR
CLASSIFICATION:	<input type="checkbox"/> LIMITED	<input type="checkbox"/> INHIBITED
		<input checked="" type="checkbox"/> 4UREYZONLY

LIST EACH ADDRESSEE SEPARATELY. USE UPPERCASE AND DOUBLE SPACING BETWEEN EACH ADDRESS

UNIDENTIFIED ALIEN SPACE
CRAFT RUMORED TO BE W/I
FACILITY PERIMETER.

TERMINATE ALIEN BEINGS
FIRST PRIORITY.

SEARCH & DESTROY VESSEL
SECONDARY PRIORITY.

cc. DR. COOK
cc. Maj. ROWE

(UNCLASS.) Final transmission from AREA-51
personnel.

TOP SECRET

THE HISTORY BOOKS

If you do well in this suicide mission, the history books will regard you as a hero for eternity. Following a heroic mission, you may enter your name in the books. Here's how:

Use your gun or controller to aim the crosshair over the character you want, then pull the trigger or press the Fire Button.

Repeat Step 1 until you've completed your entry. Select the (left) arrow to back up and fix mistakes. Select Done to enter your name.

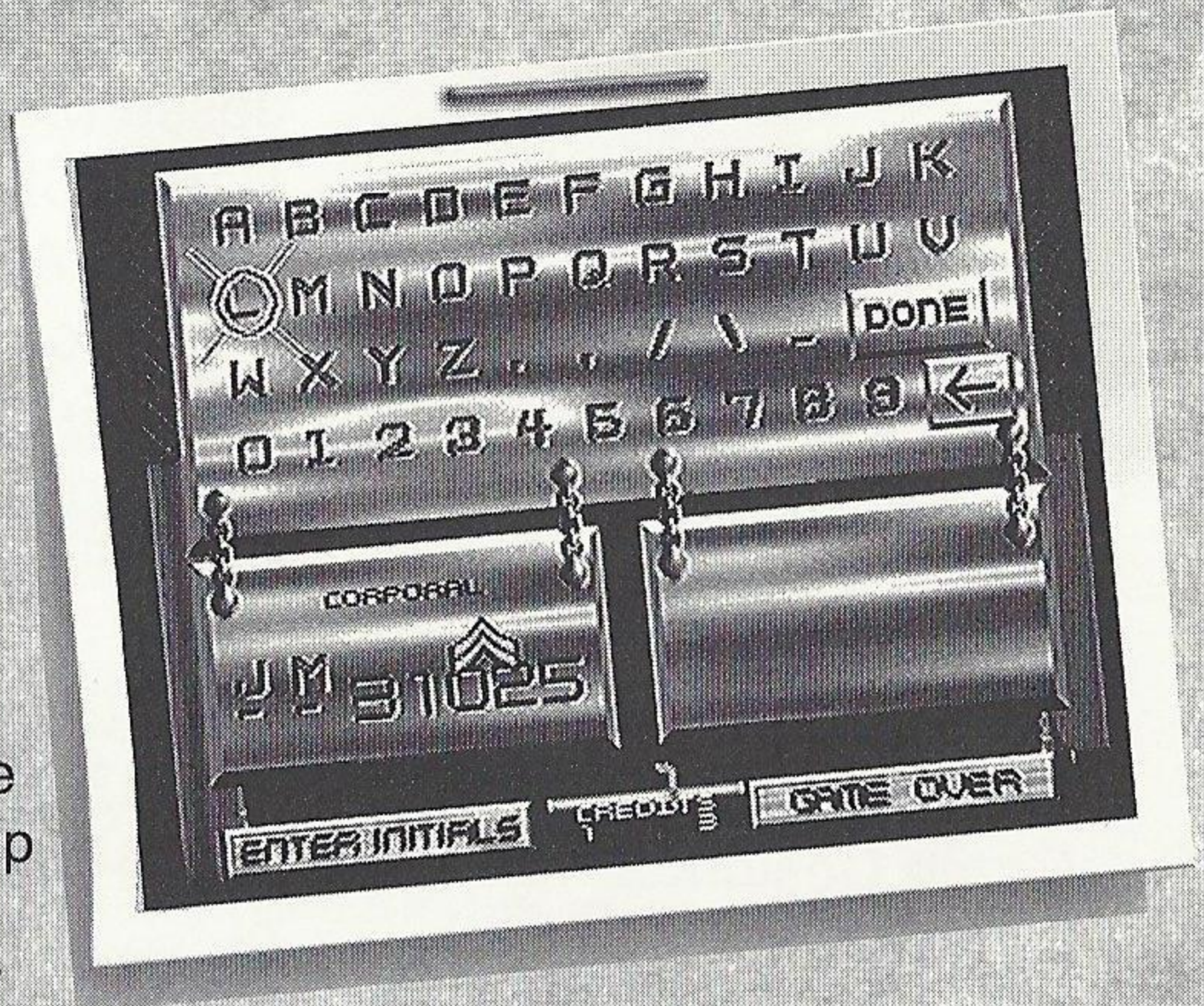

Your name will be displayed as one of the Top Ten S.T.A.A.R soldiers to take on the Kronomorphs.

Afterwards, the talk show circuit will await you.

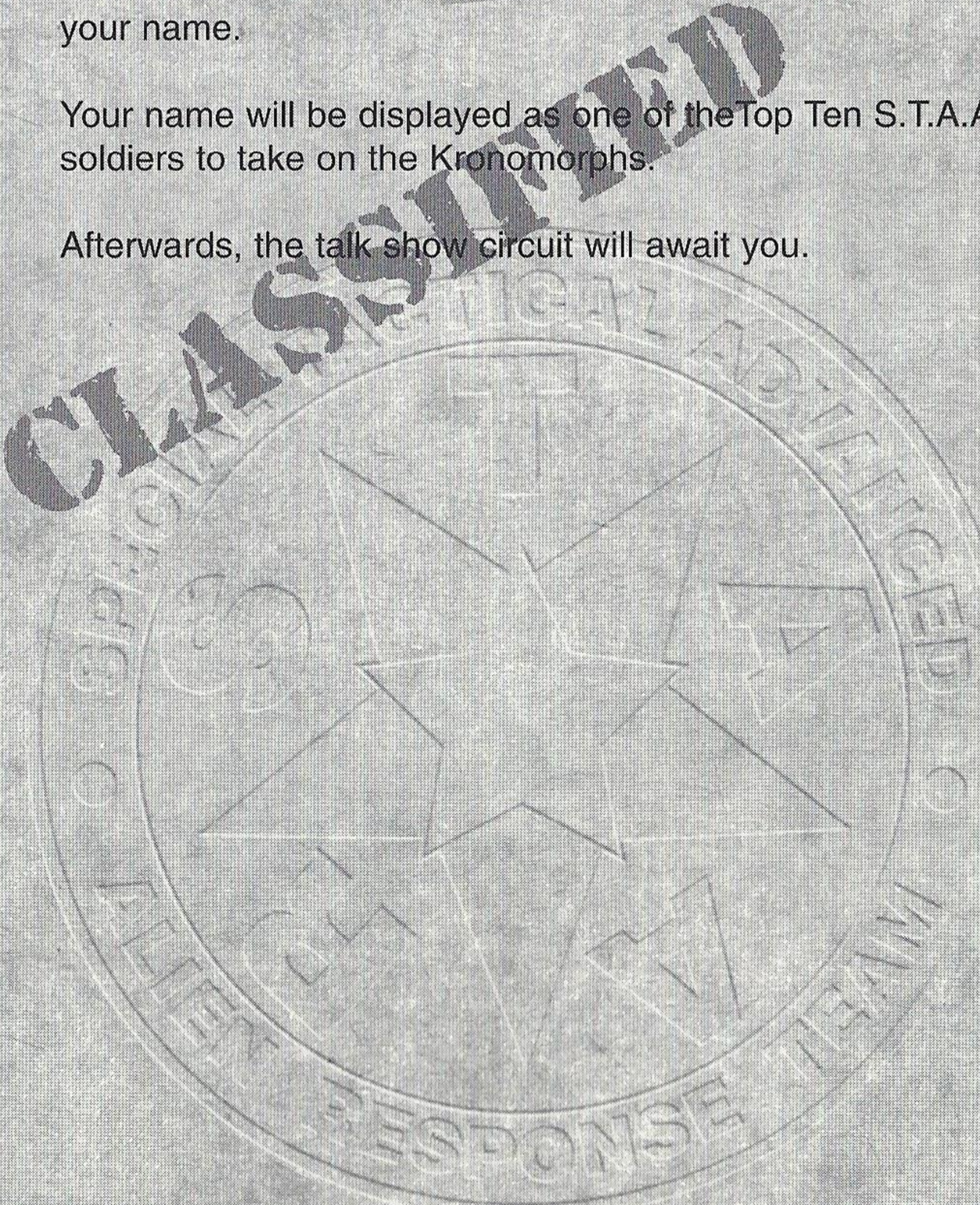

CREDITS

MIDWAY HOME ENTERTAINMENT TEAM

Producer	Ken Humphries
Test Supervisor	Mike Kruse
Lead Tester	Rob Reininger
Testers	Todd Papy, Chris Thornton, Jesse Meza, Pablo Buitrago & Randy Slafsky
Print & Production	Debbie Austin, Shawn Murphy, Dave Young & Jon Mongelluzzo
Special Thanks	Brian Fritts, Bill Hindorff, Howard Lehr, Tona Hess & Kirby Fong (GT Interactive)

COIN OP TEAM

Producer	Rob Rowe
Programmer	Charlie Grisafi
Game Design	Mike Hally
Art & Design	Steve Caterson
Video Production	Brent Englund
Lead Technician	Darrell Robinson
Stop-Motion Animator	Jody Burgess
Product Manager	Derryl DePriest
Audio & Music	Jeanne Parson & Michael Stein
Hardware Engineer	Brian McKee

MESA LOGIC

Concept & Game Design	Robert Weatherby
3D Animators	James Mestemaker, Guy Fumagalli, Hector Silva & James Webb

TANTALUS ENTERTAINMENT

Programmer	Julian Crooke
Artist	Alun Bjorksten
Executive Producer	Arthur Kakouris
Support Programmer	Shane Stevens
Quality Assurance	John Szoke
Technical Director	Andrew Bailey

PERFECT ENTERTAINMENT

Producer	Colin Fuidge
Quality Assurance	Matt Stamps

WARRANTY

MIDWAY HOME ENTERTAINMENT INC. warrants to the original purchaser of this Midway Home Entertainment Inc. software product that the medium on which this computer program is recorded is free from defects in materials and workmanship for a period of ninety (90) days from the date of purchase. This Midway Home Entertainment Inc. software program is sold "as is," without express or implied warranty damages of any kind, and Midway Home Entertainment Inc. is not liable for any losses or damages of any kind resulting from the use of this program. Midway Home Entertainment Inc. agrees for a period of ninety (90) days to either repair or replace, at its option, free of charge, any Midway Home Entertainment Inc. software product, postage paid, with proof of purchase, at its Factory Service Center.

This warranty is not applicable to normal wear and tear. This warranty shall not be applicable and shall be void if the defect in the Midway Home Entertainment Inc. software product has arisen through abuse, unreasonable use, mistreatment or neglect. THIS WARRANTY IS IN LIEU OF ALL OTHER WARRANTIES AND NO OTHER REPRESENTATIONS OR CLAIMS OF ANY NATURE SHALL BE BINDING ON OR OBLIGATE MIDWAY HOME ENTERTAINMENT INC. ANY IMPLIED WARRANTIES APPLICABLE TO THIS SOFTWARE PRODUCT, INCLUDING WARRANTIES OF MERCHANTABILITY AND FITNESS FOR A PARTICULAR PURPOSE, ARE LIMITED TO THE NINETY (90) DAY PERIOD DESCRIBED ABOVE. IN NO EVENT WILL MIDWAY HOME ENTERTAINMENT INC. BE LIABLE FOR ANY SPECIAL, INCIDENTAL, OR CONSEQUENTIAL DAMAGES RESULTING FROM POSSESSION, USE OR MALFUNCTION OF THIS MIDWAY HOME ENTERTAINMENT INC. SOFTWARE PRODUCT.

Some states do not allow limitations as to how long an implied warranty lasts and/or exclusions or limitations of incidental or consequential damages so the above limitations and/or exclusions of liability may not apply to you. This warranty gives you specific rights, and you may also have other rights which vary from state to state.

MIDWAY CUSTOMER SUPPORT

903-874-2683

10:00am -6:30pm Central Time

Monday - Friday

Midway Home Entertainment Inc.
1800 S. Business 45
Corsicana, TX 75110

Patent Numbers: U.S. Nos. 4,442,486/4,454,594/4,462,076/5,371,792; Europe Nos. 80244; Canada No. 1,183,276; Hong Kong No. 88-4302; Singapore No. 88-155; U.K. No. 1,535,999



MIDWAY[®]



Sega and Sega Saturn are trademarks of SEGA ENTERPRISES, LTD.

AREA 51™ ©1995 ATARI GAMES CORPORATION. ALL RIGHTS RESERVED. DEVELOPED BY MESA LOGIC, INC. CONVERTED BY TANTALUS AND PERFECT ENTERTAINMENT LTD. AREA 51™ IS A TRADEMARK OF ATARI GAMES CORPORATION. DISTRIBUTED BY MIDWAY HOME ENTERTAINMENT INC. UNDER LICENSE FROM ATARI GAMES CORPORATION. MIDWAY® IS A REGISTERED TRADEMARK OF MIDWAY GAMES INC. USED BY PERMISSION.

This game is licensed for use with the Sega Saturn system only. Security Program ©SEGA 1994 All Rights Reserved. Unauthorized copying, reproduction, rental, public performance or broadcast of this game is a violation of applicable laws.