

MARIO KART™

Double Dash!!™

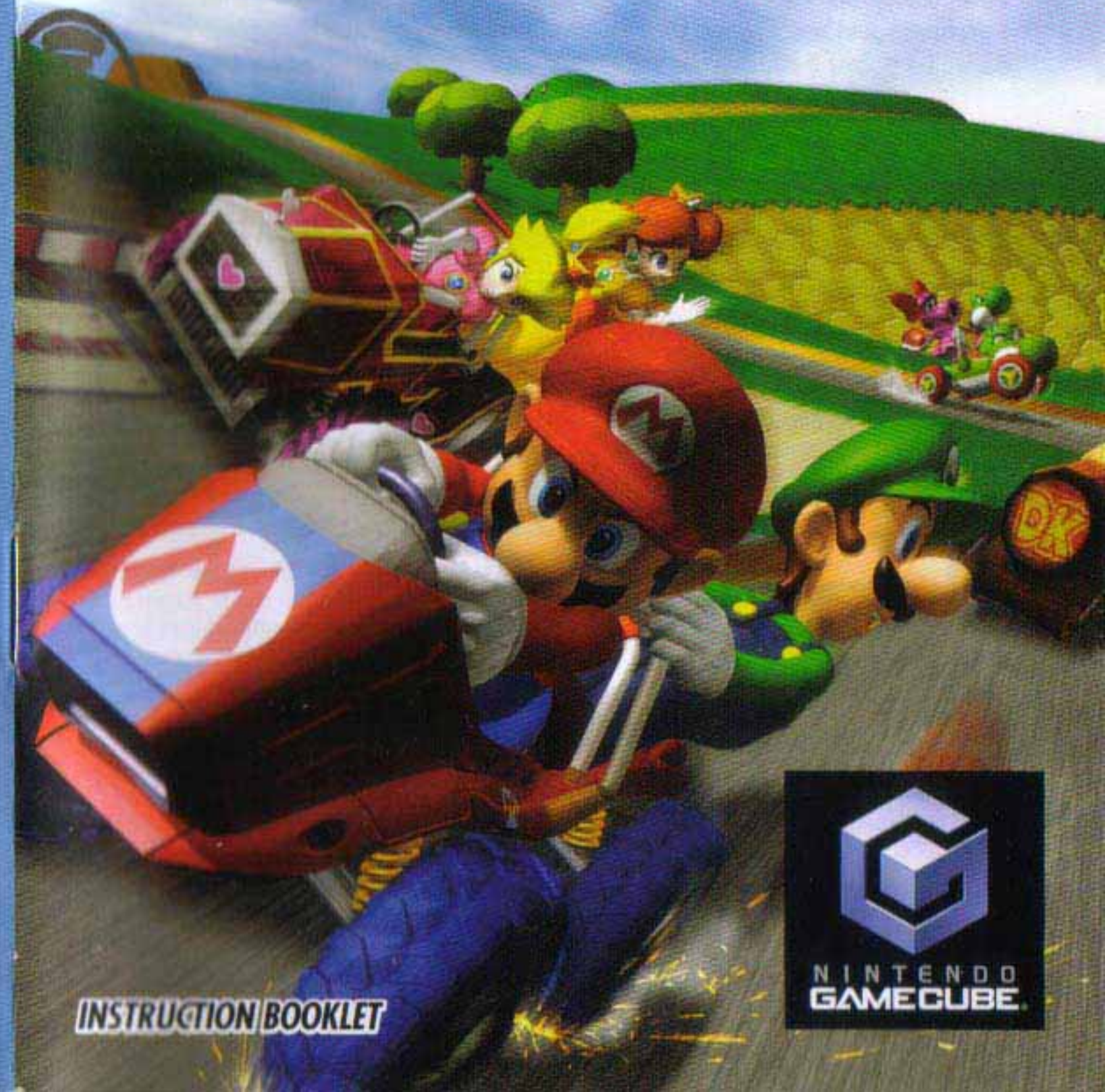

Nintendo®

NINTENDO AUSTRALIA PTY. LTD.
Scoresby Industrial Park, 804 Stud Road,
Scoresby Victoria 3179 Australia
<http://www.nintendo.com.au>
NEW ZEALAND AGENT MONACO CORPORATION LTD.
10 Rothwell Avenue, Albany, Auckland

EmuMovies



* 5 1 5 2 6 0 2 0 0 *

INSTRUCTION BOOKLET



WARNING: PLEASE CAREFULLY READ THE PRECAUTIONS BOOKLET INCLUDED WITH THIS PRODUCT BEFORE USING YOUR NINTENDO® HARDWARE SYSTEM, GAME DISC OR ACCESSORY. THIS BOOKLET CONTAINS IMPORTANT SAFETY INFORMATION.

IMPORTANT SAFETY INFORMATION: READ THE FOLLOWING WARNINGS BEFORE YOU OR YOUR CHILD PLAY VIDEO GAMES

WARNING - Seizures

- Some people (about 1 in 4000) may have seizures or blackouts triggered by light flashes, such as while watching TV or playing video games, even if they have never had a seizure before.
- Anyone who has had a seizure, loss of awareness, or other symptom linked to an epileptic condition should consult a doctor before playing a video game.
- Parents should watch when their children play video games. Stop playing and consult a doctor if you or your child have any of the following symptoms:

Convulsions	Eye or muscle twitching	Loss of awareness
Altered vision	Involuntary movements	Disorientation

To reduce the likelihood of a seizure when playing video games:

1. Sit or stand as far from the screen as possible.
2. Play video games on the smallest available television screen.
3. Do not play if you are tired or need sleep.
4. Play in a well-lit room.
5. Take a 10 to 15 minute break every hour.

WARNING - Repetitive Motion Injuries

Playing video games can make your muscles, joints or skin hurt after a few hours. Follow these instructions to avoid problems such as Tendinitis, Carpal Tunnel Syndrome or skin irritation:

- Take a 10 to 15 minute break every hour, even if you don't think you need it.
- If your hands, wrists or arms become tired or sore while playing, stop and rest them for several hours before playing again.
- If you continue to have sore hands, wrists or arms during or after play, stop playing and see a doctor.

WARNING - Electric Shock

To avoid electric shock when you use this system:

- Use only the AC adapter that comes with your system.
- Do not use the AC adapter if it has damaged, split or broken cords or wires.
- Make sure that the AC adapter cord is fully inserted into the wall outlet or extension cord.
- Always carefully disconnect all plugs by pulling on the plug and not on the cord. Make sure the Nintendo GameCube power switch is turned OFF before removing the AC adapter cord from an outlet.

CAUTION - Motion Sickness

Playing video games can cause motion sickness. If you or your child feel dizzy or nauseous when playing video games with this system, stop playing and rest. Do not drive or engage in other demanding activities until you feel better.

CAUTION - Brightness of TV Screen

The brightness of the TV screen differs with each TV but can typically be adjusted. Always play games with the appropriate brightness setting. Excessive brightness or darkness can cause discomfort. If necessary, please refer to the instructions manual of your TV for guidance on adjusting the brightness of your TV.

CONTROLLER NEUTRAL POSITION RESET

If the L or R Buttons are pressed or the Control Stick or C Stick are moved out of neutral position when the power is turned ON, those positions will be set as the neutral position, causing incorrect game control during game play.

To reset the controller, release all buttons and sticks to allow them to return to the correct neutral position, then hold down the X, Y and START/PAUSE Buttons simultaneously for 3 seconds.



This seal is your assurance that Nintendo has reviewed this product and that it has met our standards for excellence in workmanship, reliability and entertainment value. Always look for this seal when buying games and accessories to ensure complete compatibility with your Nintendo Product.



Thank you for selecting the MARIO KART™ Double Dash!!™ Game Disc for your NINTENDO GAMECUBE® System.

Please read this instruction booklet thoroughly to ensure maximum enjoyment of your new game. It also contains important warranty and hotline information. Always save this book for future reference.



THIS GAME SUPPORTS SIMULTANEOUS GAME PLAY WITH ONE, TWO, THREE OR FOUR PLAYERS AND CONTROLLERS.



THIS GAME IS COMPATIBLE WITH THE NINTENDO GAMECUBE BROADBAND MODEM.

This game supports the Broadband Adapter for play via a LAN (Local Area Network) only.



THIS GAME REQUIRES A MEMORY CARD FOR SAVING GAME PROGRESS, SETTINGS OR STATISTICS.

Please refer to the Nintendo GameCube instruction booklet for direction on how to format and erase Memory Card files.



Dolby, Pro Logic, and the double-D symbol are trademarks of Dolby Laboratories. Manufactured under license from Dolby Laboratories.

To play games that carry the Dolby Surround Pro Logic II logo in surround sound, you will need a Dolby Surround Pro Logic II or Dolby Surround Pro Logic decoder. These decoders are sold separately.



© 2003 NINTENDO.

ALL RIGHTS, INCLUDING THE COPYRIGHTS OF GAME, SCENARIO, MUSIC AND PROGRAM, RESERVED BY NINTENDO. TM, ® AND THE NINTENDO GAMECUBE LOGO ARE TRADEMARKS OF NINTENDO. © 2003 NINTENDO. ALL RIGHTS RESERVED.

THIS PRODUCT INCLUDES SOFTWARE DERIVED FROM THE RSA SECURITY INC. MD5 MESSAGE-DIGEST ALGORITHM. COPYRIGHT © 1991-2, RSA SECURITY INC. CREATED 1991. ALL RIGHTS RESERVED.

CONTENTS

CONTROLS [SINGLE PLAY]	8
CONTROLS [CO-OP PLAY]	10
DRIVING TECHNIQUES	12
GETTING STARTED	14
ITEMS	16
CHARACTERS AND SPECIAL ITEMS ...	18
KART CHARACTERISTICS	22
MODES	24
GRAND PRIX	25
TIME TRIALS	27
VERSUS	29
COURSES	30
BATTLE MODE Double Dash!!	32
BATTLE MODE STAGES	35
LAN SETUP	36

60Hz MODE

60Hz mode (unlike 50Hz mode) is not supported by every TV.

On TVs that support 60Hz mode (PAL60 compatibility) this game can be displayed at 60Hz for an even clearer display with higher quality.

To activate 60Hz mode, select 60Hz mode when "This version is compatible with 60Hz mode. Please select mode." is displayed.

If you have chosen 60Hz mode and your television does not display this mode correctly, please turn OFF the power to the NINTENDO GAMECUBE and then turn the power ON again before selecting 50Hz mode.

The Double Dash Grand Prix!

THE MUSHROOM KINGDOM'S PREMIER RACING EVENT IS BACK! HOWEVER, THERE'S BEEN ONE MAJOR CHANGE TO THE RULES OF THE ROAD...

THERE ARE NOW TWO RIDERS PER KART!

NOW, RIDERS FROM THROUGHOUT THE LAND HAVE COME TOGETHER TO TEST THEIR DRIVING SKILLS. WHICH PAIR WILL PROVE THE FASTEST?



Double the riders, double the fun!



CHOOSING CHARACTER COMBINATIONS

Karts can hold two riders: one in front and one in back. The front character handles driving duties, while the character in the back controls the use of items. You can choose any combination of characters you like. It's only natural to pair up the brothers Mario and Luigi, but how about a tandem of Mario and his arch-rival Bowser?



TWICE THE ITEMS, TWICE THE EXCITEMENT!

Each rider can carry an item, so you can now ready two surprises at a time. Block the road with double Bananas, or send out consecutive Red Shells to punish anyone in front of you. Use items and your imagination to create strategic mayhem.



TEAMWORK IS THE KEY IN CO-OP MODE!

It's no longer one kart per player! In single play, one person controls the kart, but in co-op mode, two players join forces to rule the road! Each player controls one of the riders. Should veteran racers take the wheel and leave items to the rookies?

THROWER





Controls

SINGLE PLAY

 This icon indicates menu-screen controls.
(Only Player 1 can make menu selections.)

L OR R BUTTON

Press and hold  or 
and use  to drift.

CONTROL STICK

Steer.

 The more you tilt
the Control Stick,
the more you turn.

 Throw items forward
or backward.

 Make menu selections.

START/PAUSE

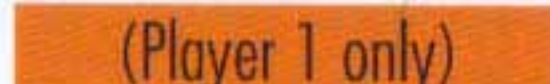
Pause races to view the pause menu.
 (Player 1 only)

Z BUTTON

Swap Positions.
Switch character positions between the
front and back.

X OR Y BUTTON

Use items with the character in
back.

A BUTTON

Accelerate.

 Confirm menu selections.

B BUTTON

Brake/Reverse.
Press while racing to brake, and
press when stopped to back up.

 Cancel menu selections.



Controls

CO-OP PLAY



L OR R BUTTON

Front Player

Press and hold or and use to drift.

Rear Player

Slide Attack.



CONTROL STICK

Front Player

The more you tilt the Control Stick, the more you turn.

Rear Player

Throw items forward or backward.

SPECIAL CONTROLS FOR CO-OP PLAY

Slide Attack

Rear Player or

Quickly slide your kart left or right while attacking. If you hit a kart that's carrying items, you'll steal an item.



Z BUTTON

Have both players press this button **simultaneously** to switch positions.



X OR Y BUTTON

Front Player

Pass items to rear player.

Rear Player

Use items.

A

A BUTTON

Front Player

Accelerate.

Rear Player

Do a Double Dash!! (>> pg. 13)
Use items.

B

B BUTTON

Front Player

Brake/Reverse.

Rear Player

Use items.

START/PAUSE

Pause races to view the pause menu.

Only Player 1 can make menu selections. (>> pg. 8-9)

Driving Techniques

Here are some driving techniques to make your time behind the wheel as fun as possible.

DRIFT

You can send your kart drifting into a sideways **power slide** by pressing either **L** or **R** while tilting the Control Stick either left or right.

Drifting lets you take corners without losing speed.



MINI-TURBO

This is a technique that gives you a split-second turbo burst. The controls differ between single play and co-op play.

CONTROLS

Single Play

While drifting, tilt the Control Stick in the direction opposite to your turn to perform a counter.



Once the sparks are red, tilt the Control Stick into the turn, then opposite the turn to do another counter.



When the sparks turn blue, stop drifting to perform a Mini-Turbo.



Co-op Play

When the front character sends the kart into a drift, the rear character should tilt the Control Stick to perform a counter.

After the sparks turn red, the rear player should do another counter.

When the sparks turn blue, the front character can stop drifting and perform a Mini-Turbo.

ROCKET START

If you press **A** just as Lakitu's start signal turns green, you'll perform a **Rocket Start**.



DOUBLE DASH!!

In co-op play you can get an even better launch if both the front and rear characters perform a Rocket Start at the same time. This is called a **Double Dash**.



STEALING ITEMS

There are three ways to steal items from rival karts. However, you can only steal items if the rear character on your kart is not already carrying an item.



HOW TO STEAL

- 1 Hit an opposing kart while using a Mushroom.
- 2 Run into another kart while using a Star.
- 3 Slide Attack a rival kart.

If both characters on the kart you hit are carrying items, you'll steal the rear character's item, and the front character's item will fall onto the course.

Getting Started

Place the Mario Kart: Double Dash!! Game Disc in the Nintendo GameCube and close the Disc Cover. Next, insert a Memory Card into Slot A and press the POWER Button. On the title screen, press START/PAUSE when prompted to create a game data file. Once a data file is created, the title screen will display again.



TITLE SCREEN SELECTIONS

Start Begin playing. (>> pg. 15)

Records View records for all of the courses raced up to this point.

Options Change game settings and Controller functions.

- Sound: Set the sound output to Mono, Stereo, or Surround.
- Volume: Use to adjust the volume.
- Rumble: Turn the Rumble feature ON or OFF.
- Time Trials Ghost: Turn the ghost ON or OFF. (>> pg. 28)
- VS. Item Box: Adjust the Item Box settings. (>> pg. 29)
- VS. Laps: Set the number of requisite course laps.

About Saving

Game data is saved in the following situations:

- When you finish a Grand Prix and achieve a new ranking.
- When you set a new record in Time Trials.
- When you change Options screen settings and select OK!



Do not press the POWER Button or remove the Memory Card while saving as this may corrupt your game data.

- This game requires 3 empty blocks to create a new game data file.
- It takes 5 empty blocks to save 1 ghost-data file. (>> pg. 28)

Please refer to the Nintendo GameCube instruction booklet for directions on how to format and delete Memory Card files.

STARTING THE GAME

1 Select the number of players.

You can play with one to four players. You will need one Controller per player.

2 Different Player Numbers, Different Game Play.

The types of game play available differ depending on the number of players and how the players are paired up.

Players	Pairing	Grand Prix	Time Trials	VS	Battle
1	1P	○	○	×	×
2	1P vs. 2P	○	×	○	○
	[1P & 2P]	○	×	×	×
3	1P vs. 2P vs. 3P	×	×	○	○
	[1P & 2P] vs. 3P	○	×	○	○
4	1P vs. 2P vs. 3P vs. 4P	×	×	○	○
	[1P & 2P] vs. [3P & 4P]	○	×	○	○
	[1P & 2P] vs. 3P vs. 4P	×	×	○	○

3 Selecting Modes

Use the Control Stick to select a mode and press the A Button. Next, select the engine size and press the A Button again. There are three engine sizes: 50cc, 100cc, and 150cc. The larger the engine size, the faster the karts.

4 Selecting Characters and Karts

You will need to select 2 characters per kart. The karts available will differ depending on the characters selected. (>> pgs. 22-23)



5 Selecting Courses

Choose the course or stage on which you want to play and get started.

RANDOM SELECTION

For step 4, Player 1 can randomly select all players' characters by pressing and at the same time before any player has selected his or her characters. For step 5, courses can be randomly selected in the same manner in Versus and Battle modes.

Items

You can acquire items by running into the Item Boxes you find on courses and stages. The items you receive are determined randomly. Here are the standard items you will find in the game, but keep in mind that there are special items, too. (Read more about those items... >>> pgs. 18-21)



Item Box

Hit one of the floating boxes and the rear character will gain an item.



Double Item Box

Run into one of these and both the rear and front characters will receive items.

WHEN CARRYING ITEMS

Characters who are already carrying items when they hit Item Boxes or Double Item Boxes will not receive any new items.

DROPPED ITEMS

Items will sometimes fall on the course when karts spin or flip. If you run into items lying on courses or stages, you will be affected by those items instantly.



STANDARD ITEMS

Here are items that can be found in Grand Prix, VS., and Battle modes.



This indicates an item can be thrown either forward or backward.



Banana

These slippery skins can be dropped or thrown in strategic spots to send rivals into sudden spins.



Green Shell

Green Shells move in straight lines when thrown and knock karts for a loop if they hit.



Red Shell

Red Shells seek out karts in front of you and flip them over when they strike.



Spiny Shell

This item does not appear in Battle mode.

This winged wonder heads straight for the leader of the pack and explodes on impact. Any kart caught in the blast area will flip.



Fake Item

These items of deception look just like real Item Boxes, so place them where your opponents won't expect.



Mushroom

These turbo toadstools give karts brief speed bursts.



Triple Mushrooms

Triple Mushrooms allow you to dash three times in a row.



Star

Stars make karts temporarily invincible and increase their top speeds by a hair. Karts hit by Star-wielding karts will go flying.



Thunderbolt

This mighty bolt strikes all opponents at the same time, causing them to spin out, drop their items, and shrink in size, which reduces their max speeds.

Characters and Special Items

Characters are divided into three groups depending on their size: light, medium, and heavy.

ABOUT SPECIAL ITEMS

Each pair of characters has a special item that other characters cannot receive. These items are picked up in the same way as standard items.

(>> pgs. 16-17)



MARIO MEDIUM

You know him, you love him—the one and only Mario! He's returned to the Grand Prix with Fireballs in hand.

LUIGI MEDIUM

He's lean, he's not so mean, and his Fireballs are green! Everybody's favourite brother is here, too!



Special Item FIREBALLS

They split up after they're thrown and go sailing ahead. These powerful pyrotechnics can take out multiple opponents at once.



This item can be thrown either forward or backward.

Special Item GIANT BANANA

Only DK and Diddy know where these monstrous fruit can be found. Once they're in the road, they're tough to manoeuvre around.

Straight from the jungle, DK uses his simian strength to scare rivals.

DONKEY KONG HEAVY

DAISY MEDIUM

This is Princess Daisy's first foray onto the speedways. She's so cute she's become something of an idol.



Special Item HEART

Flying hearts surround the royal ladies' karts, and any item that hits them becomes theirs to use. A cute and handy item.

DIDDY KONG LIGHT

His charm is in his amazing tail. Donkey Kong convinced him to race in the Grand Prix.

PEACH MEDIUM

Normally the epitome of grace, once she's on the raceway, Princess Peach really tears it up.

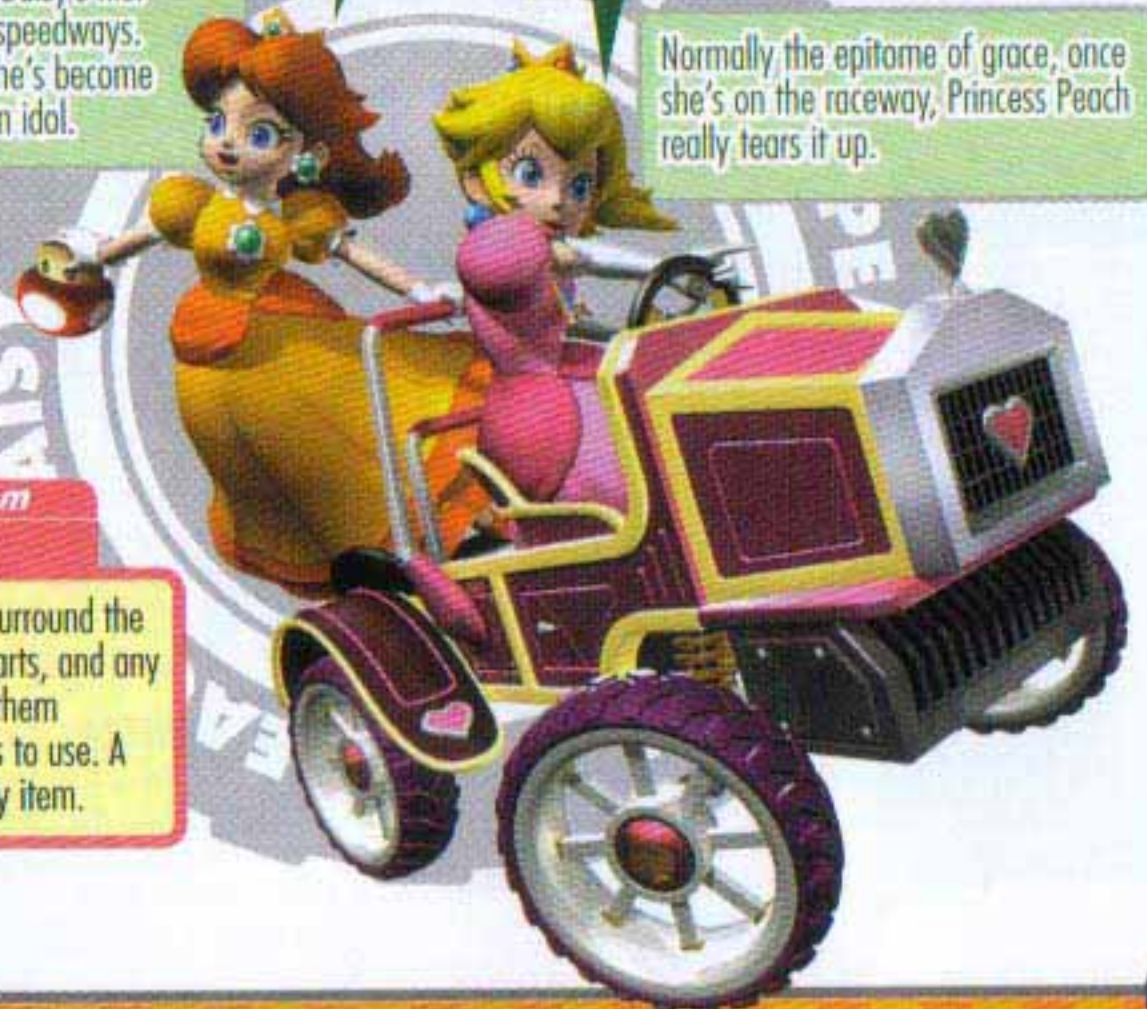

PARATROOPA LIGHT

Paratroopa takes care of its wings even in the heat of the race.

Special Items
TRIPLE SHELLS (GREEN / RED)
Don't let Koopa and Paratroopa worry about not having enough shells. Get three at a time!

KOOPA LIGHT

Usually a faithful underling of Bowser, it shows even the big boss no mercy during a race.

BABY LUIGI LIGHT

Special Item
CHAIN CHOMP
This fearsome beast chases karts with reckless abandon, pulling the babies behind it at breakneck speeds.

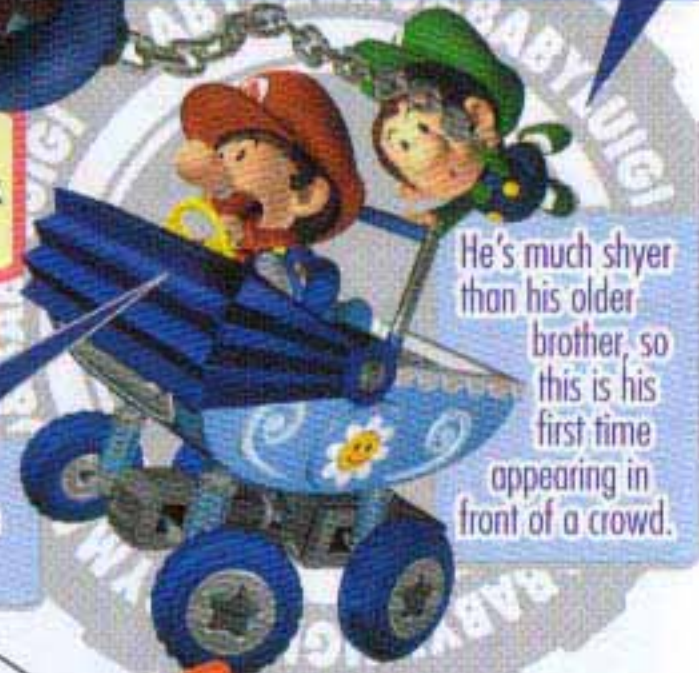

He's much shyer than his older brother, so this is his first time appearing in front of a crowd.

BABY MARIO LIGHT

Baby Mario and Mario...together in the same game?!? He's got quite an amazing pet this time around.

YOSHI MEDIUM

Taking a break from carrying Mario, Yoshi's ready to burn up the courses.

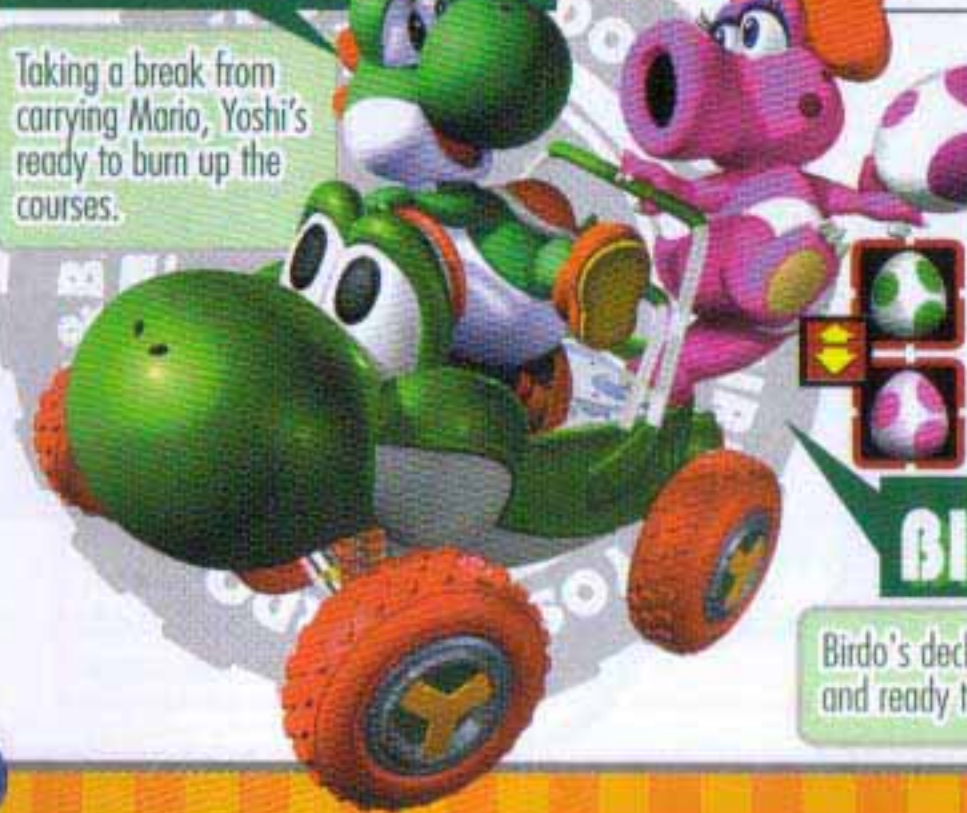

Special Items
YOSHI'S EGG
BIRDO'S EGG
These eggs roll down the road and home in on opponents. When they hit and break, they'll drop three more items.

BIRDO MEDIUM

Birdo's decked out in her favorite bow and ready to race!

BOWSER JR. LIGHT

An energetic troublemaker who's ready to drive out of his father's shadow.

BOWSER HEAVY

Mario's archnemesis. Will racing with his son make him behave better?

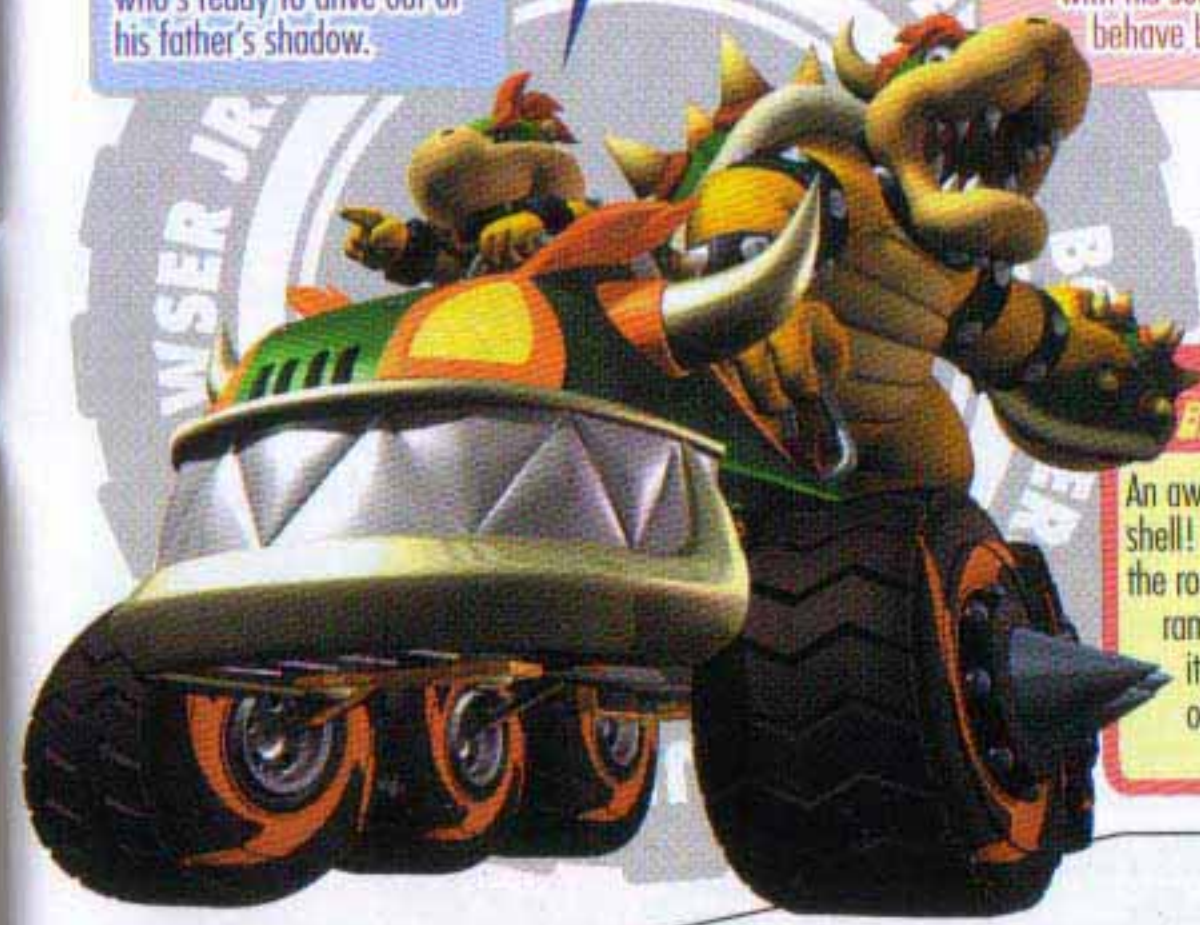

Special Item
BOWSER'S SHELL
An awe-inspiring giant shell! As it careens down the road, slamming and ramming into karts, it's the very image of Bowser himself.

WALUIGI MEDIUM

Ever fond of sneaky, underhand attacks, he's in his element when he's armed with a Bob-omb.

WARIO HEAVY

Wario's ready to cruise in his purple pride and joy. Its top speed is over 280 mph! ...But for the Mario Kart Grand Prix, its engine has been tuned down.



Special Item
BOB-OMB
Take aim and give your opponents an explosive surprise. Mess up, and you might just hit yourself! This item's dangerous...

Kart Characteristics

Just like the characters, karts are divided into three classes—light, medium, and heavy. Characters cannot ride in karts that are smaller than they are. This chart illustrates which characters can ride in which karts.

CHARACTERS AND KARTS

 Light Character

 Medium Character

 Heavy Character

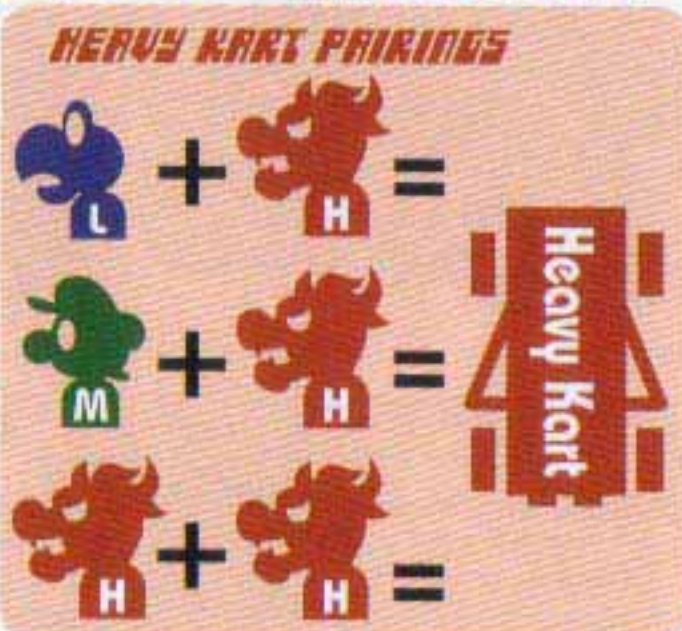

LIGHT KART CHARACTERISTICS

 Light karts have good acceleration but fairly low top speeds. They don't lose too much speed when they go off course.

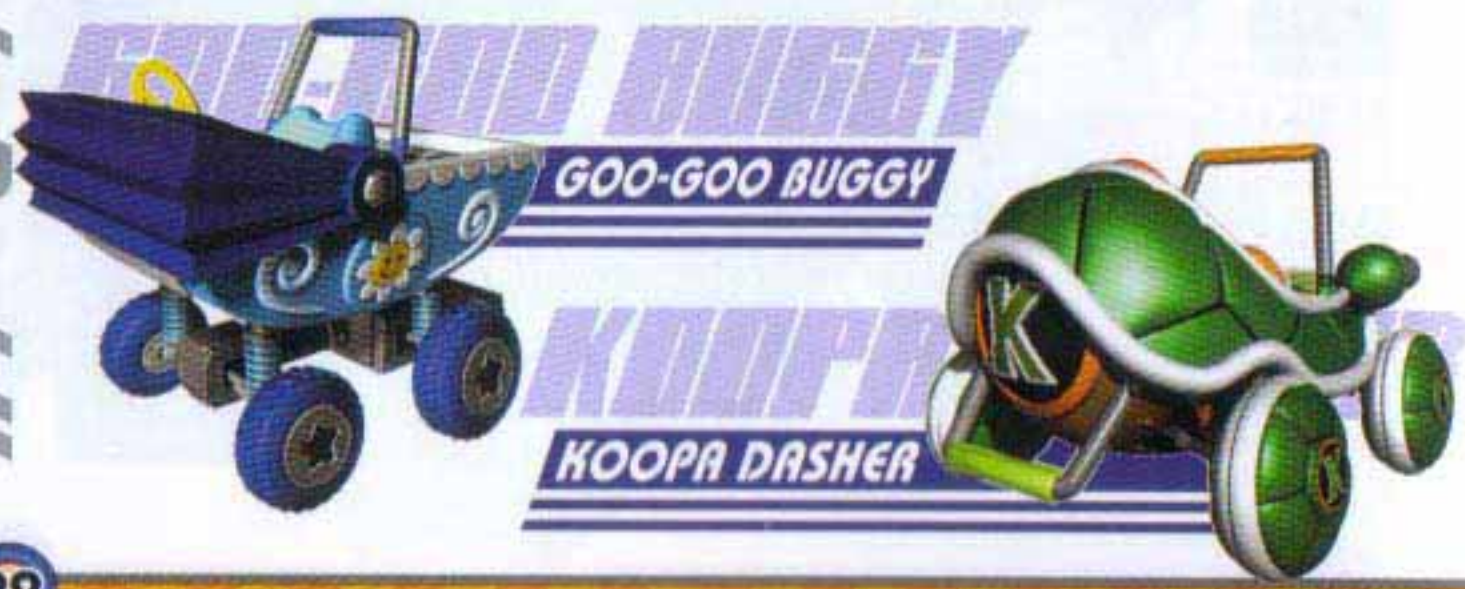

MEDIUM KART CHARACTERISTICS

 Medium karts have average acceleration and top speeds.



HEAVY KART CHARACTERISTICS

 Heavy karts have poor acceleration but great top speeds. They send light and medium karts bouncing away if they hit them and lose a lot of speed when they go off-road.



MARIO KART: Double Dash!!

MARIO KART: Double Dash!!

Modes

There are four game modes in Mario Kart: Double Dash!!

GRAND PRIX

Eight karts race through four courses for total points. (>> pgs. 25-26)

TIME TRIALS

Select a course, and race a set number of laps to see how fast you can finish. (>> pgs. 27-28)

VERSUS

The only karts on the track are controlled by human players. Choose the course and get started. (>> pg 29)

BATTLE

This mode is for player-controlled karts only. There are three types of battle games. (>> pgs.32-35)

ABOUT THE PAUSE MENU (FOR PLAYER 1 ONLY)

You can press START/PAUSE mid-race to halt the game, display the pause menu, and quit playing.

Pick selections with .
Confirm with .



Continue	Return to game play.
Quit	Return to the title screen.
Restart	Begin the race again.
Change Course	Return to the Select Course screen.
Change Stage	Return to the Select Stage screen.
Change Characters	Return to the Select Character Combination screen.
Change Battle	Return to the Select Battle screen.
Next Course	Continue on to the next course.
Award Ceremony	Continue on to the award ceremony.
View Replay From Start	View the replay you're watching from the beginning.
Retry	Race the same course with the same conditions as before.
Save Ghost	Save ghost data. (>> pg. 28)

GRAND PRIX

No. of Players	Kart Size	Co-op
1 - 2	50 - 150	Yes

There are three Cups in the Grand Prix mode. Each Cup consists of four courses. A race is held on each course, and the participating eight karts vie for top honours by aiming for the highest total points.

CHOOSING A CUP

On the Select Cup screen, choose the Cup to be raced.

Mushroom Cup



Comparatively easy. Great for beginners.

Flower Cup



A bit difficult. For veteran players.

Star Cup



Very hard. Designed for experts.

SCREEN INFORMATION

There's lots of information displayed on-screen during races.

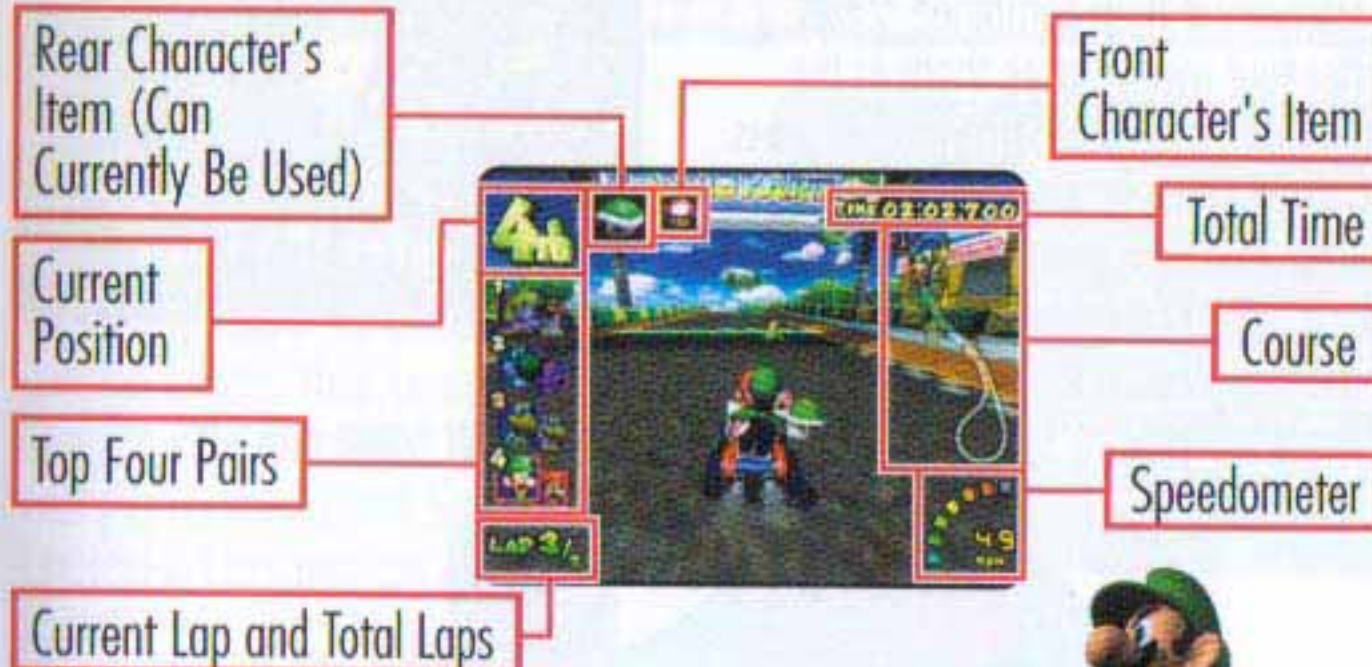

When two players are racing:

P1 Screen



P2 Screen



GRAND PRIX RULES

• Driver Points

Drivers receive points depending on where they finish races. After racing four courses, their total points determine where they place.

1st	2nd	3rd	4th	5th	6th	7th	8th
10 Points	8 Points	6 Points	4 Points	3 Points	2 Points	1 Point	0 Points

• Results Screen

Once a race is over, the results screen will display, showing where each kart placed and the distribution of points.

Rank	Name	Lap Time	Time Diff	Points
1	Wario	02:18:335	+10	23 POINTS
2	Luigi	02:22:706	+8	10 POINTS
3	Donkey Kong	02:22:730	+6	26 POINTS
4	Waluigi	02:22:784	+4	18 POINTS
5	Yoshi	02:22:820	+3	14 POINTS
6	Princess Peach	02:23:602	+2	8 POINTS
7	Boo	02:25:086	+1	3 POINTS
8	Dr. Mario	02:27:097	+0	0 POINTS

• Trophies

Players will take part in an awards ceremony if their combined score after four races places them in the top three. The first-place finisher wins a gold trophy, second place wins silver, and third wins bronze. After each award ceremony, players will have the chance to enter their names if new records are set. Trophy data will be saved after name entry is completed.



TIME TRIALS

No. of Players

Co-op

1

No

Race courses over a set number of laps to record the fastest completion time. Players start races with two Mushrooms in hand.

SCREEN INFORMATION



TIME TRIALS RULES

• Name Entry

When playing Time Trials mode, you'll start off by entering your name. Use \leftarrow \rightarrow to select and change letters, then press \bullet to confirm your selections. When name entry is complete, the Select Character Combination screen will appear.



• Results Screen

When you finish a race, the total time and individual lap times will appear. If your total time is higher than current recorded times, the rankings will be changed.



ABOUT GHOSTS

A ghost is a recording of the player's best time played on a particular course during Time Trial. You can choose to display this recording as a semi-transparent "ghost" that will drive the exact same line as the record-setting race.

Ghost data can be saved to Memory Cards. Saving ghost data requires 5 blocks per file. You can use the Memory Card in either Slot A or Slot B. On the Load and Save Ghost Data screens, you can switch the Memory Card to save or load ghost data.

If the Ghost setting is turned OFF on the Options screen, you will be unable to save or load ghost data.

• Loading Ghost Data

Once you select a course that has ghost data saved on the Memory Card in Slot A or B, the Load Ghost Data screen will display. Use  to select a Memory Card and press **A** to display available ghost data. Select the ghost data to be loaded and press **A** to confirm your choice. Press **B** to return to the previous screen.

• Saving Ghost Data

After finishing a race, or during replay of a race, you can select Save Ghost from the pause menu to proceed to the Save Ghost Data screen. Select a Memory Card with  and press **A** to confirm. Choose which existing ghost data you wish to overwrite and press **A** to save.

If you choose to overwrite existing ghost data, that data will be lost forever. Be careful!

WHEN YOU CAN'T SAVE GHOST DATA

- If a race takes too long.
- If a completed race is not faster than the current loaded ghost data.

If you choose Restart after the race or from the pause menu, either the currently loaded ghost data or the fastest data from the current play session will be used.

VERSUS

No. of Players	Kart Size	Co-op
2 - 4	50 - 150	Yes

Come here to race between two and four player-controlled karts. Select the course to be raced and hit the road. The race is finished when everyone but the last-place racer crosses the finish line.

SCREEN INFORMATION

When two players are racing:



P2 Screen

When three players are racing:



When four players are racing:



ITEM BOX SETTINGS

You can set the percentages at which items appear from Item Boxes on the Options menu.

Recommended: All items appear with a balanced frequency.

Basic: Powerful items are hard to find.

Frantic: Powerful items appear with high frequency.

None: No Item Boxes or Double Item Boxes will appear.

LAPS SETTING

You can set the number of laps to be raced in VS. competition on the Options menu.

COURSES

Here's an intro to some of the courses you'll see in Grand Prix, Time Trials, and Versus modes.

MUSHROOM CUP



◀◀ Luigi Circuit

Though the Chain Chomp is a bit noisy, this is relatively peaceful course. The front straight and the back straight run parallel to each other, so you'll see your rivals coming and going. Whether you opt for the outside line and the dash panels or

cut it close and stay on the inside track is up to you.

▶▶ Peach Beach

Princess Peach's favorite beach resort! Beware the Cataquacks wandering about the shoreline. The course changes with the tide, so watch the waterline for your chance at a big shortcut.



FLOWER CUP



◀◀ Mushroom Bridge

One of the Mushroom Kingdom's most famous landmarks. This bridge is well travelled, so be careful not to run into any commuters. The car carrying all the mushrooms looks strangely inviting, though...

▶▶ Mario Circuit

This is the main circuit in Mario Kart: Double Dash!! Familiar denizens of the Mushroom Kingdom can be spotted here and there. The road's filled with curves, so this is a good place to practice drifting.



STAR CUP



◀◀ Sherbet Land

A beautiful course covered a blanket of white snow. Don't be lulled into complacency though—the ice is very slippery! Careless driving may result in multi-kart pileups.

▶▶ Mushroom City

This course takes you through downtown Mushroom City in the dead of night. It's easy to take a wrong turn and get lost. The key to victory is avoiding the inner-city traffic.



DASH PANELS

On some of the courses, you will find Dash Panels. Steer your kart over one of these to receive a momentary burst of speed.



BATTLE MODE

No. of Players	Co-op
2 - 4	Yes

Need a break from racing? Come here to compete against your friends in three different Battle modes on four different stages.



BALLOON BATTLE

Lose the balloons attached to your kart and you're out! You'll lose one balloon each time you're hit by something or run into any damage-dealing items. Characters can use all special items.

When two karts are playing:



HOW TO LOSE BALLOONS

- 1 Get hit by an enemy's item attack and spin or flip.
- 2 Fall off the stage.
- 3 Get hit by another kart when it's using a Mushroom or a Star.
- 4 Get hit by a Slide Attack.

Can you regain a balloon?

If you're down to two balloons or less, use either method 3 or 4 to steal a balloon from an opponent.



SHINE THIEF

Pick up the Shine that drops on the course, and a timer will begin counting down. If you can hold on to the Shine until the timer reaches zero, you win. If someone steals the Shine, attack him and get it back before the timer reaches zero. All special items are available to every character in this battle mode.

When two karts are playing:



HOW TO DROP THE SHINE

- 1 Get hit by an item attack and spin or flip.
- 2 Drive out of the battle stage.
- 3 Get rammed by an opponent who's using a Star or a Mushroom.
- 4 Get hit by a Slide Attack.

How to Steal the Shine

Use technique 3 or 4 as listed above to steal the Shine from another kart.



BOB-OMB BLAST

Ready, aim, fire! Toss Bob-ombs at opponents and try to hit them. Each time you blow up an opponent, you get a point. Depending on the number of players, the first to three or four wins. Careful, though: if you get hit, you lose a point. In this Battle mode, the only items that appear are Bob-ombs. Each character in a kart can carry several Bob-ombs at a time. Explosions from your own Bob-ombs do not hurt you.

When two karts are playing:

P1 Screen

Points



Stage Map

P2 Screen



BATTLE MODE STAGES

Here are four stages created just for Battle mode.



Cookie Land

Battle atop a giant cookie. Hurl items over the four different-coloured toppings to hit enemies from a distance!

Block City

A square stage made of blocks. Chase enemies who throw stuff at you. Watch out for the intersection—it's a dangerous place to be!



Nintendo GameCube

What's this? A giant Nintendo GameCube?!? There are no obstacles on this course, so the action is fast and frantic.



Pipe Plaza

Use the warp pipes to zip from place to place. This is wide stage, so you can run, but can you hide?



LAN Setup

If you have Broadband Adapters (sold separately), an over-the-counter hub, and LAN cables, you can set up a LAN system so that each player will be able to play Mario Kart: Double Dash!! on his or her own television.

USING A HUB TO PLAY

Use multiple TVs to have a multiplayer match with up to 8 player-controlled karts.

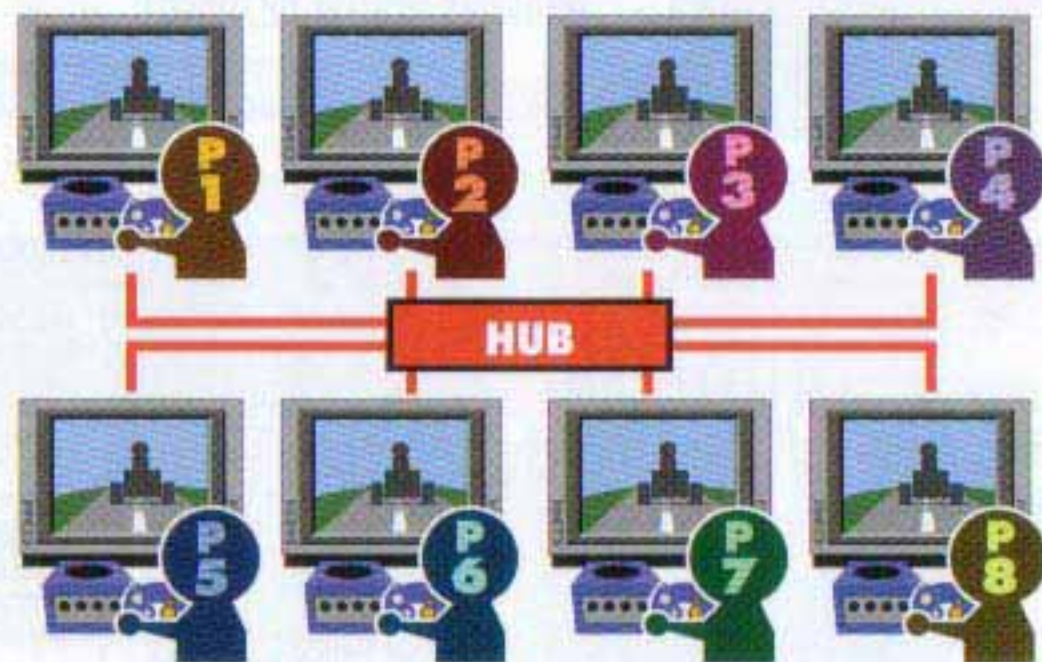

USING A CROSSOVER CABLE SETUP TO PLAY

This setup allows for up to eight players to play on split-screens on two TVs.

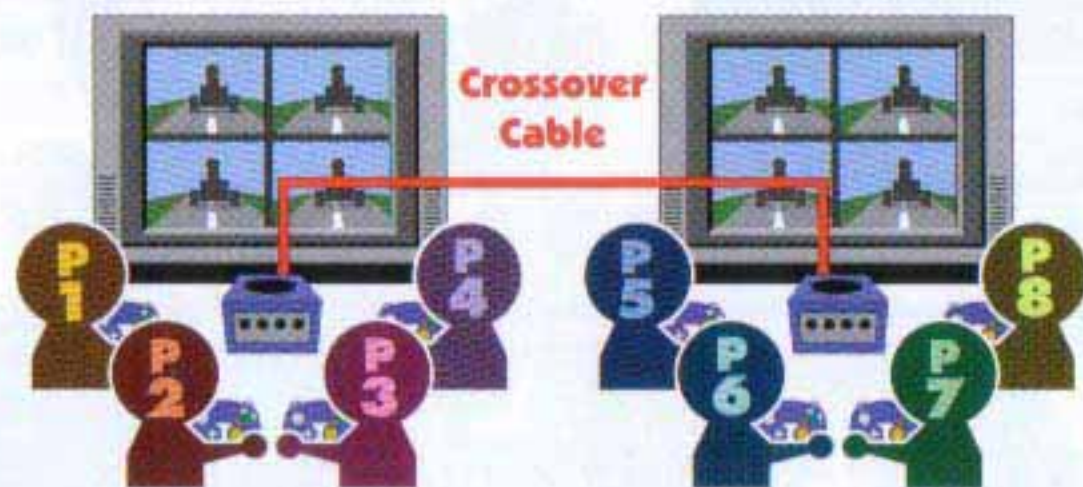

Mario Kart: Double Dash!! is not just for 1-kart-on-1-screen multiplayer game play. By using split-screens and co-op play, there are lots of variations you can explore.

PLAYING VS. USING LAN

After connecting the Nintendo GameCube systems to be used, press all the systems' POWER Buttons. (➤ pgs. 14-15)

The LAN Mode option will appear on each title screen. Once LAN Mode has been selected and confirmed on all participating game systems and the connections have been established, the Select Mode screen will display. Press **A** after completing game setup to display the LAN Mode title screen. Select START GAME, complete the entry process, and start racing!



VS. LAN Menu

Use **Left Arrow** to choose a menu item, set up that item with **Right Arrow** and press **A** to confirm. Once this is finished, you'll move to the LAN Mode title screen.

Start Game: Begin Versus LAN play.

Select Mode: Adjust LAN setup options.

- Game Mode: Choose the mode you want to play:
Versus, Balloon Battle, Shine Thief.
You can only choose the number of laps and engine size in Versus Mode.
- Order of Courses (Stages): Choose the way in which courses (stages) will be selected.
Random, All Courses (Stages)
1 Course (Stage), All Cups (Versus only)
- Co-op: *Turn Co-op ON or OFF.*
- Screen Division: This will only appear when there are less than 4 Nintendo GameCube systems in use.

Quit LAN Mode: Stop playing LAN Mode.

With the Nintendo GameCube, you can create a LAN system by connecting game systems and a hub with Broadband Adapters and LAN cables. **You cannot use this setup for Internet play.**

If an error occurs during setup, follow the on-screen instructions and try connecting again.

➤ See pgs. 38-39 for equipment and setup instructions to play VS. LAN.

Connecting Multiple Nintendo GameCubes With a Hub

By using an over-the-counter 10BASE-T hub and LAN cables, you can connect a maximum of **8** Nintendo GameCubes to enjoy racing with friends using up to **8** player-controlled karts.

Required Equipment

- Nintendo GameCube system with Broadband Adapters: 2 to 8
- *Mario Kart: Double Dash!!* Game Discs: 1 per system
- Memory Card with *Mario Kart: Double Dash!!* save data: 0 to 8
- Nintendo GameCube Controller: 1 per player
- 10BASE-T Hub: 1
- LAN cables compatible with the hub to be used: 1 per system
- TVs: 1 per system

Standard LAN cables are straight cables, but some hubs use crossover cables. For details see the instruction manual of the hub you are using, and use the appropriate LAN cables.

Connection Instructions

1. Turn all game systems OFF and then connect the LAN cables from the hub to the Broadband Adapter of each Nintendo GameCube (see the diagram below and check the instruction manual of the hub you are using).
2. Turn the hub ON.
3. Place the *Mario Kart: Double Dash!!* Game Discs in each of the Nintendo GameCube systems.
4. Turn all the game systems ON.
5. For further instructions, see page 36.

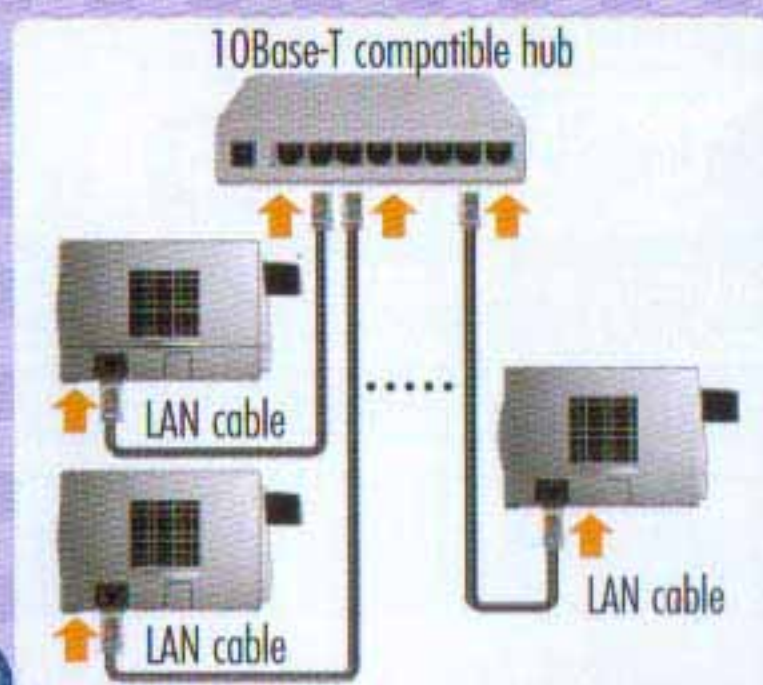

Nintendo GameCube and Hub Connections

Be sure to read your hub instructions, too. Do not connect any Nintendo GameCube systems to the hub unless they will be used.

Instructions for Connecting Nintendo GameCube Game Systems With Crossover Cable

You can connect two Nintendo GameCube game systems using a crossover cable compatible with an over-the-counter 10BASE-T hub.

Required Equipment

- Nintendo GameCube system with Broadband Adapters: 2
- *Mario Kart: Double Dash!!* Game Discs: 2
- Memory Card with *Mario Kart: Double Dash!!* save data: 0-2
- Nintendo GameCube Controller: 1 per player
- 10BASE-T Hub compatible crossover cable: 1
- TVs: 2

Connection Instructions

1. Turn both game systems OFF and then connect the crossover cable to the Broadband Adapter of each Nintendo GameCube.
2. Place the *Mario Kart: Double Dash!!* Game Discs in each of the Nintendo GameCube systems.
3. Turn all the game systems ON.
4. For further instructions, see page 36.

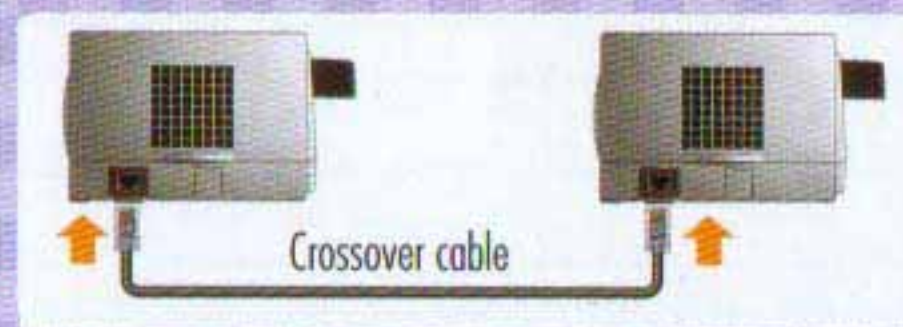

Troubleshooting

You may experience malfunctions or be unable to connect in any of the following situations:

- When you are using a LAN cable that is not compatible with the hub in use, or when using a cable other than a crossover cable when connecting two Nintendo GameCube systems directly.
- When any LAN cable is not fully inserted into the hub or any game system.
- When any LAN cable is removed during the transfer of data.
- When any game system is turned OFF or any game system's RESET button is pressed during the transfer of data.
- When something other than a Nintendo GameCube is connected to the hub.
- When a hub or LAN cable not compatible with the 10BASE-T standard is being used.
- When more than 8 Nintendo GameCube systems are connected.

NOTES

MARIO KART: Double Dash!!

NOTES

MARIO KART: Double Dash!!

Important

REV-A

WARNING: Copying of any Nintendo game is illegal and is strictly prohibited by domestic and international intellectual property laws. "Back-up" or "archival" copies are not authorized and are not necessary to protect your software. Violators will be prosecuted.

This Nintendo game is not designed for use with any unauthorized copying device or any unlicensed accessory. Use of any such device will invalidate your Nintendo product warranty. Nintendo (and/or any Nintendo licensee or distributor) is not responsible for any damage or loss caused by the use of any such device. If use of such device causes your game to stop operating, disconnect the device carefully to avoid damage and resume normal game play. If your game ceases to operate and you have no device attached to it, please contact Nintendo Customer Service.

The contents of this notice do not interfere with your statutory rights.

This booklet and other printed materials accompanying this game are protected by domestic and international intellectual property laws.

12 MONTH WARRANTY FOR NINTENDO GAMECUBE® (GAME DISC) REV-Q

You may only require simple instructions to correct a problem with your product, therefore we recommend the following services:

NINTENDO HELPLINE 190 224 1001

Set-up, connection and gameplay assistance together with hints and tips for a wide range of Nintendo products.

Live Games Experts available between 12 noon and 7pm, every day of the year.

Recorded information on our most popular titles available 24 hours per day.

INFORMATEL ONLINE CALL RATE AT \$1.98 PER MINUTE INCLUDING GST

(Calls from mobile and public phones attract a higher rate)

NINTENDO WEBSITE www.nintendo.com.au

Troubleshooting, warranty and service/repair information.

CONDITIONS OF WARRANTY

The benefits conferred by this Warranty are in addition to all other conditions and warranties in respect of this product which the consumer may have under the Trade Practices Act 1974 of the Commonwealth of Australia and/or similar State, Territory or Country Laws.

Nintendo Australia Pty Limited warrants this GameCube (GAME DISC) to be free of defects in materials, workmanship and manufacturing to the original purchaser for a period of twelve months after the date of purchase and upon presentation of purchase receipt.

1. Nintendo Australia Pty Limited will at its option and subject to the terms and conditions stated below, repair or replace free of charge this GAME DISC or any component part, which upon examination by Nintendo Australia Pty Limited is found to be defective.

2. This Warranty shall not apply:

(a) If the GAME DISC has been subjected to misuse, abuse, accident or want of care.

(b) If the GAME DISC has been modified and/or tampered with.

(c) If a repair has been made or attempted by the purchaser or their agent.

(d) The following are not covered by this Warranty:

(i) Liquid damage;

(ii) Scratched or damaged discs;

(iii) Wear and tear.

(e) If the GAME DISC fails due to causes unrelated to defective materials or workmanship.

3. Nintendo Australia Pty Limited accepts no liability pursuant to this Warranty for any cost or consequential damage or economic loss whether direct or indirect, to any person or property, arising from breakdown or failure of this product and no responsibility is to be implied or accepted over and above the replacement value of the product.

This Warranty is given by Nintendo Australia Pty Limited and no other person or organisation is authorised to vary its provisions and conditions.

Before returning a Nintendo GameCube® GAME DISC for service, contact:

Nintendo Customer Service on (03) 9730 9822

Warranty and Repair information and all other general enquiries.

Hours of operation: 8:30am to 5:30pm Monday to Friday (EST).

NINTENDO AUSTRALIA HEAD OFFICE

Scoresby Industrial Park, 804 Stud Road, Scoresby Victoria 3179 Australia