

OWNER'S MANUAL

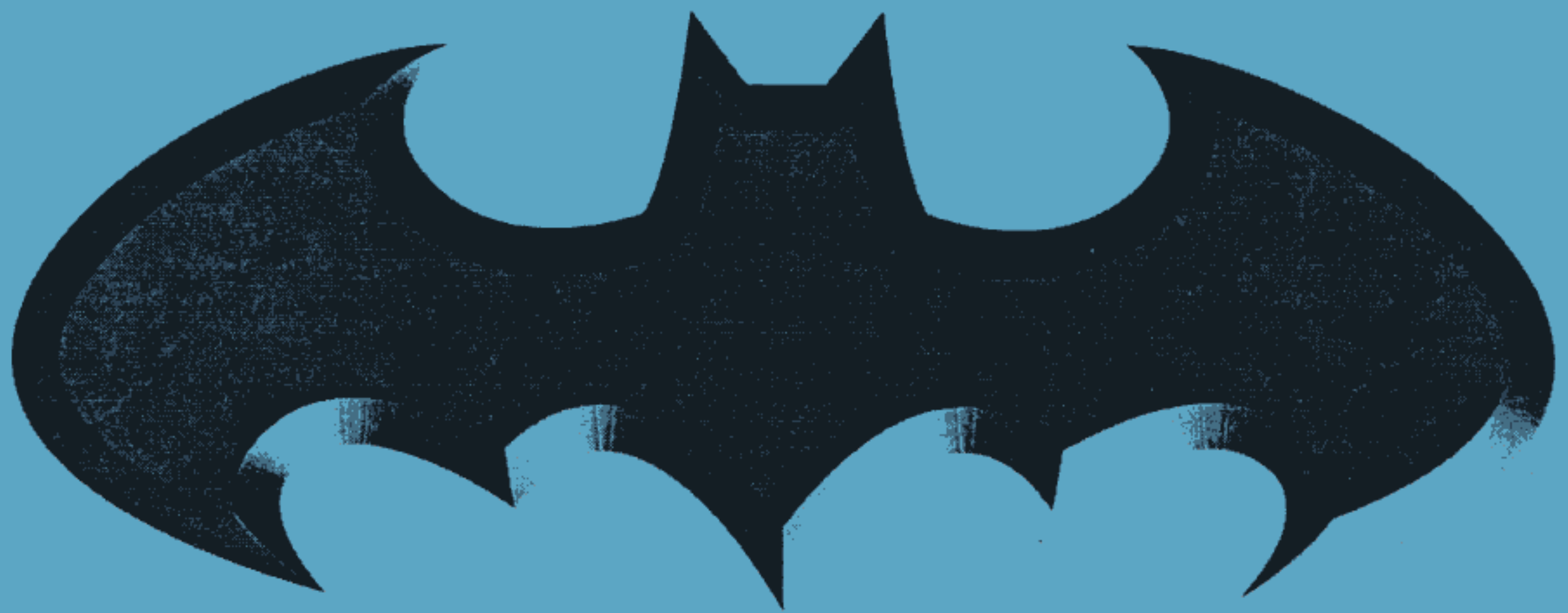

B A T M A N™
F O R E V E R



Acclaim ... SERIOUS COIN!

Sales: Acclaim Coin-operated entertainment, inc., 2593 Coast Avenue, Mountain View, CA 94943

(415) 528-2100 phone, (415) 528-2185 fax

Customer Service: Lazer-Tron Corp., 4430 Willow Road, Pleasanton, CA 94588

(510) 460-0873 phone, (510) 460-0365 fax

P/N CUS252265 Rev A

Copyright © 1996 Acclaim entertainment, inc.

TABLE OF CONTENTS

<i>READ ME FIRST!</i>	2
Disclaimers & Safety Guide	3-4
Product Specifications	4
Copyrights, Trademarks, Patents	5
Functional Description of BATMAN™ FOREVER	6
<u>Installing the Game</u>	7-8
Test Mode & On Screen Menus	9-14
Main Menu	9
Memory Test Screen	10
CRT Test Screen	10
Input Test Screen	10
Clock Adjustment Screen	10
System Assignments Screens	11
Coin Assignments Screen	11
System Bookkeeping Screen #1	11
System Bookkeeping Screen #2	12
Backup Data Clear	12
BATMAN™ FOREVER Main Menu	12
Volume Adjust Screen	13
Batman Input Test Screen	13
Game Data Screen	14
View Bookkeeping Screen	14
Sound Options Screen	14
Color Adjustment Screen	14
Troubleshooting	15-16
Spare Parts List	17
Appendix A	18
Assemblies	19-20
Wiring Diagrams	21-28
<u>Installing the Kit</u>	29
Kit Parts List	30
Kit Installation Instructions	31-32
Power Supply Requirements	31
Kit Button & Joystick Drill Pattern	33
Kit Wiring Diagrams	34-39

READ ME FIRST!!!

Do NOT Turn on the Game until you have read the following:

This game is set up to accept **120 VAC 60 Hz** input voltage. Any other voltage or frequency requires switching the power supply, replacing the light bulbs and changing the power cord. Call Lazer-Tron's Customer Service at (510)460-0873 or your distributor for further information.

Only authorized and trained personnel should work on this game.

DISCLAIMERS AND SAFETY GUIDE

The following safety precautions apply to all game operators and service personnel. Specific warnings and cautions will be found in this manual whenever they apply.

WARNING!

Properly Ground the Game!

The coin doors are grounded at the factory. If this grounding is removed or the game is not plugged into a grounded three-wire outlet, the players may receive an electrical shock! To avoid electrical shock, **do not** plug in the game until it has been inspected and properly grounded. If you have only a two wire outlet, we recommend you hire a licensed electrician to install a three wire grounded outlet. After servicing any part on the doors, or other grounded metal, check that the grounding wire is firmly secured to a solid metal surface.

AC Power Connection

Before you plug in the game, be sure that the game's power supply can accept the AC line voltage in your location. The line voltage requirements are contained in the Product Specification section on this manual.

Disconnect Power During Repairs

To avoid electrical shock, reduce the risk of fire hazard, and prevent equipment damage, perform the following safety practices when servicing this game. Disconnect the game from the AC power before removing or repairing any part of the game. The power supply can retain charge for a period of time even after the AC power is removed. Use care when working near the power supply, or on any circuitry connected to it. Make sure the indicator LED's on the PC Boards are completely OFF (dark, not dimly lit) before servicing the boards or the wiring. When repairs are completed, **DO NOT** turn on power with the harness connectors unplugged - live electrical parts will be exposed. Do not reconnect any harnesses while the power is on. Severe damage to the PCBs may occur.

Use the proper Fuses

To avoid electrical shock, reduce the risk of fire hazard, and prevent equipment damage, use only the replacement fuses which are specified on the power supply itself. Replacement fuses must match those that are being replaced in fuse type, voltage rating, and current rating.

Caution!!! Properly attach all connectors. Make sure that the connectors on each printed circuit board are properly plugged in. The connectors are keyed to fit only one way. If they do not slip into place easily, do not force them. If you reverse a connector, you may damage your game and void your warranty.

Notice regarding non Acclaim Parts!!!

Use of non Acclaim parts or modifications of any Acclaim game circuitry may adversely affect the safety of your game and may cause injury to you and your players.

DISCLAIMERS AND SAFETY GUIDE, continued

FCC Information:

This equipment generates, uses, and can radiate radio frequency energy and if not installed and used in accordance with the instruction manual, may cause interference to radio communications. It has been tested and found to comply with the limits for a Class A computing device pursuant to Subpart J Part 15 of the Federal Communications Commissions Rules, which are designed to provide reasonable protection against such interference when operated in a commercial environment. Operation of this equipment in a residential area or modification to this equipment is likely to cause interference, in which case the user, at his own expense, will be required to take whatever measures may be required to correct the interference. If you suspect interference from a Acclaim product at your location check the following:

- 1) All ground wires are properly connected as shown in the game wiring diagram.
- 2) The power cord is properly plugged into a grounded three wire outlet.
- 3) All power supply and PC Board shields are installed correctly.

UL Listing Information: BATMAN™ FOREVER is a UL Listed game. Installation of any non UL parts will void the UL listing and may seriously affect the safety of the game.

CE Certified IEC 1000-4-3:1995 Radiated Electromagnetic Field Immunity

CISPR 22A; 1985 Emission IEC 1000-4-4:1995 Electrical Fast Transient/Burst Immunity

IEC 1000-4-2, 1995 Electrostatic Discharge

PRODUCT SPECIFICATIONS

Characteristic	Specification
Power Consumption	540 Watts Maximum
Temperature	+5 to +50 degrees C (+37 to +122 F)
Line Voltage	120 VAC (Standard Factory Wiring) For 200-240 VAC, minor modifications are required. See the "READ ME FIRST" section of this manual.
Line Current	4.5 Amps Nominal at 120 VAC.
Width	33.50 inches.
Depth	41.50 inches
Height	76.00 inches.
Weight	317 pounds.

COPYRIGHTS, TRADEMARKS, AND PATENTS

Copyright © 1996 Acclaim

All Rights Reserved

Designed and Manufactured by Acclaim

Patent Pending

Batman™ and all related elements are the property of DC Comics.

No part of this publication may be reproduced by any mechanical, photographic or electric process, or the form of a phonographic recording, nor may it be stored in a retrieval system, transmitted or otherwise copied for public or private use, without the permission from the publisher.

The game play, all graphic designs, this technical manual, and its accompanying schematic diagrams are protected by the US. Copyright Act of 1976.

This Act provides for substantial penalties for violating federal copyright laws. Courts can impound infringing articles while legal action is pending. If infringers are convicted, courts can order destruction of the infringing articles.

In addition, the Act provides for payment of statutory damages of up to \$50,000 per infringing transaction in certain cases. Infringers may also have to pay cost and attorney's fees and face an imprisonment of up to five years as well as fines of up to \$250,000 in the case of individuals and up to \$500,000 in the case of business entities.

Acclaim will aggressively enforce its copyrights against infringers. We will use all legal means to immediately halt any manufacture, distribution, or operation of a copy of any games not made or sold by us or our affiliates. Anyone who purchases such copies risks forfeiting such a game.

Published by: *Acclaim Coin-operated entertainment, inc.*
2593 Coast Avenue
Mountain View, CA 94043
(415) 528-2100 phone
(415) 528-2185 fax

Functional Description of BATMAN™ FOREVER

HOW TO PLAY:

1. Insert coin(s).
2. Press 1 player or 2 player button.
3. Use joystick to move Batman or Robin.
4. Use buttons to have your character jump, punch, kick, block or evade.
5. There are also secret Lethal Combos for both Batman and Robin.
6. The game ends when the selected character runs out of energy.
7. The player(s) has 10 seconds to coin up for continued play. If player does not coin up in 10 seconds, the game is reset to the first level. There are three levels of skill.

INSTALLING THE GAME

Tools Required: Side cutter or knife to cut the strapping
 Phillips screwdriver
 7/16" Socket wrench

Persons required to lift game and set in place: 1-2

PACKING LIST: BATMAN™ FOREVER Packaging, consisting of 2 boxes:

<u>BOX #</u>	<u>DESCRIPTION</u>	<u>QUANTITY</u>
1	BATMAN™ FOREVER Cabinet	1
	Pairs of keys	4
	Owner's manual (CUS 252265)	1
	Power Cord	1
2	Control Panel	1
	Bolts, 1/4-20 x 2" Hex Head	4
	Washers, 1/4" Flat	4
	Lock washers, 1/4"	4
	Screw, #6 x 5/8" PPH	5

If you require assistance, call Lazer-Tron customer service at (510) 460-0873

- **Warning !!!! Failure to follow these instructions may cause injury or damage. Do not plug the game into a 120 VAC wall socket until you have completed the following inspection steps.**
- This game is wired for a power line voltage of **120 VAC, 60 Hz**. The lamps in this game are rated for 120 VAC. The power supply is set for 120 VAC but can be switched to 200-240 VAC. See the "READ ME FIRST" section of this manual for modifications or call Lazer-Tron's Customer Service for assistance. **(510) 460 0873**.
- Remove the pair of keys from the coin return slot. There will be 3 more sets of keys either in the cashbox or hanging inside the coin door.
- Refer to figure 1 on the next page for installation of the Control Panel box using the supplied 1/4-20 hardware.
- Hanging inside the front of the cabinet you will find a Monitor Adjusting board and 2 harnesses. Attach the Monitor Adjust board to the inside bottom of the Control Panel box using the 3 #6 x 5/8" screws provided. Connect the harnesses to their mating halves. Red controls the right player, white controls the left player.

Screw the "New Game" card on top of the BATMAN™ game against the front of the cleat using 2 of the #6 x 5/8" provided screws.

INSTALLATION, continued

- **Before you power up**, please inspect the BATMAN™ FOREVER game carefully to ensure that the game is complete and was delivered in good condition. Inspect all printed circuit boards for snug wire connections. Re-secure as necessary.
- Plug in the game. The power switch is located on the back of the game on the power supply. Turn on the power. Visually check if the Red LED on the Sega Titan board is on.
- On power up, a “beep” sound is followed by the audio attract sounds. Check for sound out of both speakers. Inspect wiring to speakers if necessary. Volume can be adjusted through the “BATMAN™ FOREVER” diagnostic menu screen.
- Refer to the Operator Adjustable Features of this manual for settings you may wish to adjust.
- Coin up and play the game. Follow instructions printed on the monitor bezel.

If you have any problems, read thoroughly the following pages before servicing or trouble shooting your BATMAN™ FOREVER game. Proceed to Test Mode & Troubleshooting sections.

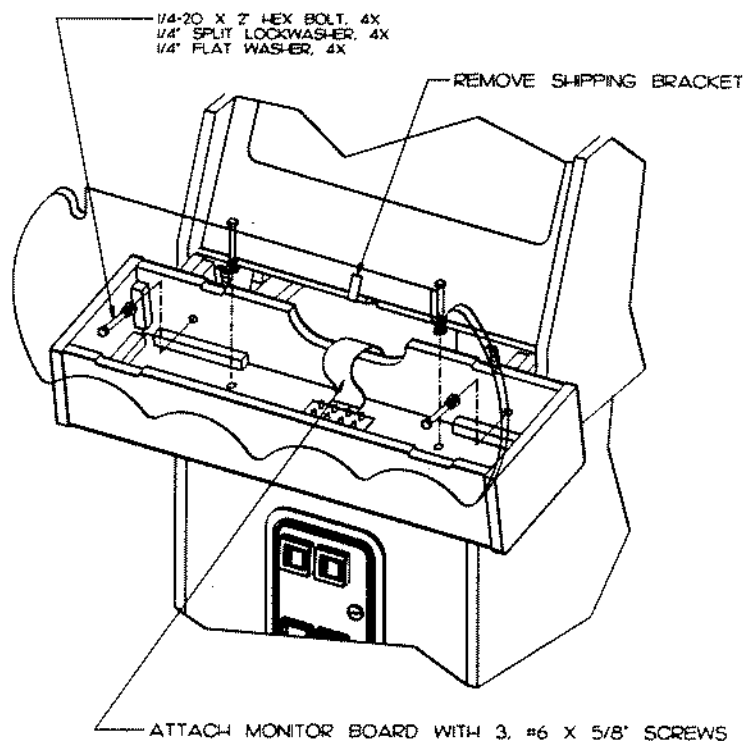

CONTROL PANEL INSTALLATION

TEST MODE & OPERATOR ADJUSTABLE FEATURES:

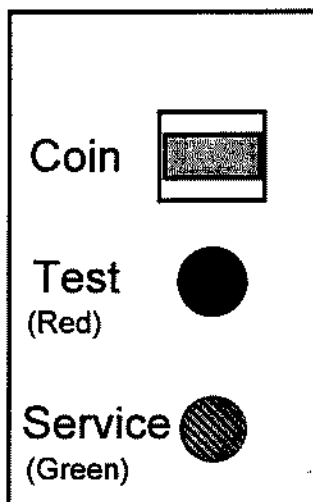

Software setups are selected by using the Red Test button and the Green Service button located in the cabinet behind the coin door.

Once in the BATMAN™ FOREVER section of the menus, selections are made using the joysticks and buttons.

BATMAN™ FOREVER is a video game. To this end, we have created a series of screens used to test and adjust the game. During this mode you will use the Test and Service buttons as input devices. To engage the test and adjustment screens, you must press the RED Test button anytime. Use the GREEN Service button to scroll through the choices. Use the red Test button to choose one. Each choice brings up another screen which may be accessed in the same manner. However, once in the BATMAN™ FOREVER series of screens, access is through the Control Panel joysticks and buttons.

MAIN MENU

MEMORY TEST
CRT TEST
INPUT TEST
CLOCK ADJUSTMENTS
SYSTEMS ASSIGNMENTS
COIN ASSIGNMENTS
SYSTEM BOOKKEEPING
BACKUP DATA CLEAR
EACH GAME TEST
BATMAN™ FOREVER
EXIT

ON SCREEN MENUS, continued

MEMORY TEST SCREEN

Used to verify all ROMs. System will automatically test IC8, 9, 10, 11, 24, 25, 27, 29, 30, 33, 34, & 37. Once started you must power down the game to stop this process.

CRT TEST SCREEN

Page 1 shows color bands (white, red, green & blue) which can be adjusted on the back of the monitor. See the monitor manual included with the game.

Page 2 is a cross hatch test screen.

INPUT TEST SCREEN

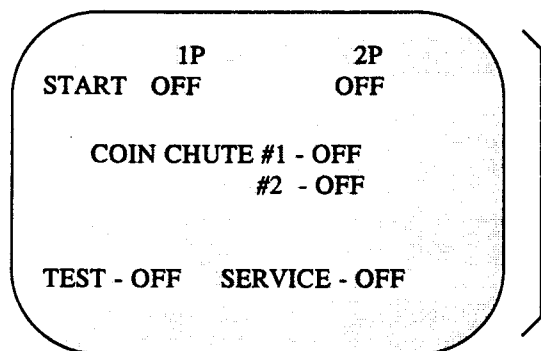

"OFF" changes to "ON" when each item is pressed

CLOCK ADJUSTMENTS SCREEN

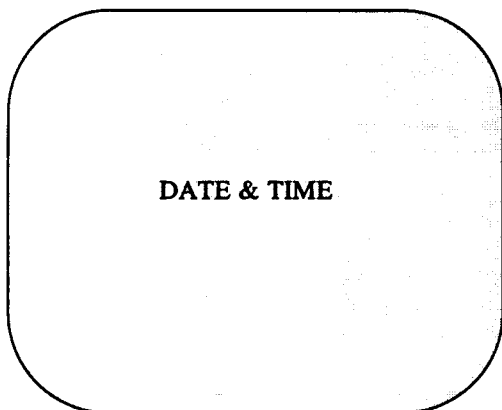

Scroll through each character to reset date & time. Scroll to "SET" and press the Test button to make change permanent.

ON SCREEN MENUS, continued

SYSTEMS ASSIGNMENTS SCREEN

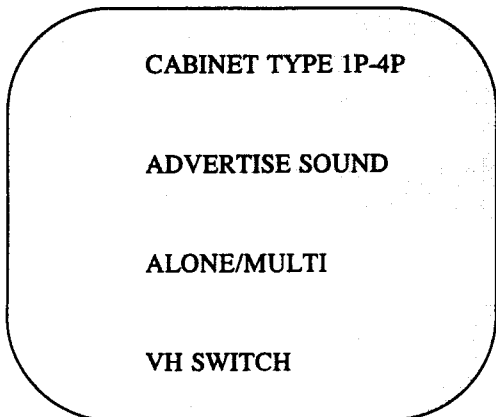

Must be 2P

Sound is set to play for 2 minutes then be silent until any button is pressed.

Must be ALONE.

Must be horizontal

COIN ASSIGNMENTS SCREEN

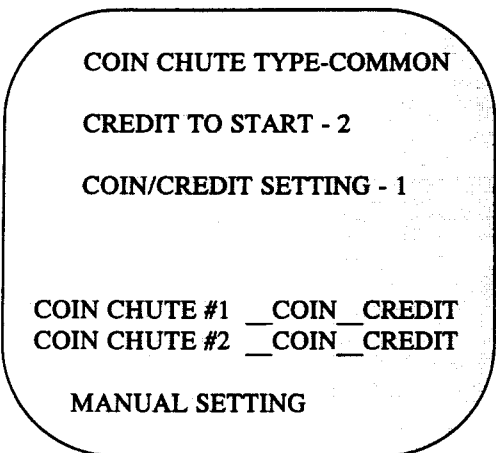

Must be Common

Toggles between 1 and 2. 2 is 50¢ to play.

Toggles from 1 to 25 and FREE PLAY. 1 is 25¢ to continue. After setting this you may make manual settings or accept factory defaults.

} Changes as you increase the COIN/CREDIT setting

Allows changes to the coin & credit settings for coin chutes 1 and 2.

SYSTEM BOOKKEEPING SCREEN #1

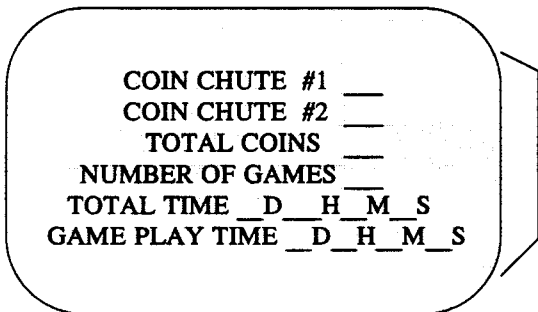

Shows current totals

SERIOUS COIN!

ON SCREEN MENUS, continued

SYSTEM BOOKKEEPING SCREEN #2

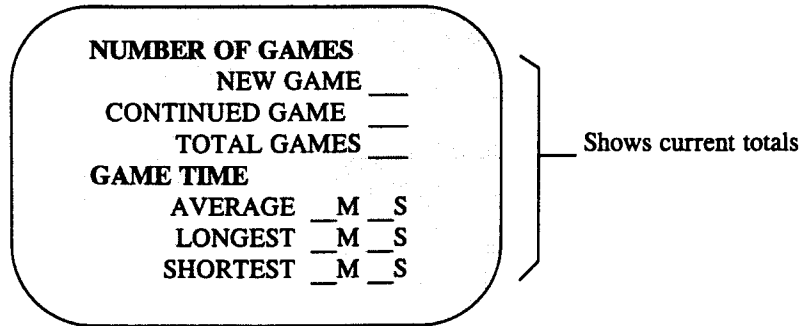

BACKUP DATA CLEAR SCREEN

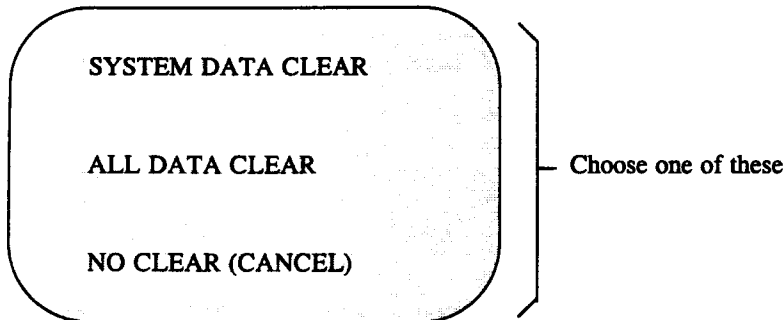

EACH GAME TEST SCREEN

BATMAN™ FOREVER MAIN MENU SCREEN

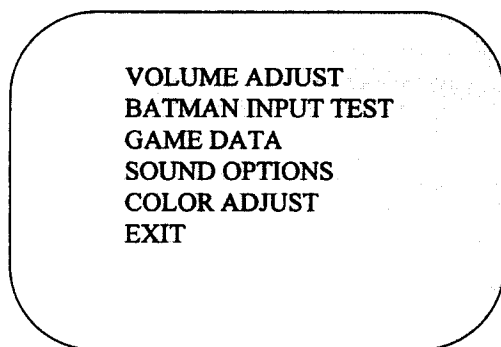

At this point selections are made using the joysticks and play buttons. Scroll down with joystick, select with start button.

ON SCREEN MENUS, continued

VOLUME ADJUSTMENT SCREEN

VOLUME 0-255

Use left joystick to increase or decrease the volume

Press start button to return to Main Menu screen.

Changing volume affects all game sounds

BATMAN™ INPUT TEST SCREEN

Player 1 Start	OFF/ON	
Player 2 Start	OFF/ON	
Coin Chute #1	OFF/ON	
Coin Chute #2	OFF/ON	
	PLAYER 1	PLAYER 2
Joystick - Left	OFF/ON	OFF/ON
Joystick - Right	OFF/ON	OFF/ON
Joystick - Up	OFF/ON	OFF/ON
Joystick - Down	OFF/ON	OFF/ON
JUMP Button	OFF/ON	OFF/ON
PUNCH/GADGETS Button	OFF/ON	OFF/ON
KICK Button	OFF/ON	OFF/ON

Return to Main Menu

As controls are tested "OFF" will change to "ON" then back to "OFF".

ON SCREEN MENUS, continued

GAME DATA SCREEN

SET DIFFICULTY
VIEW BOOKKEEPING
RESET HIGH SCORES
RESET BOOKKEEPING
EXIT

Easy/Medium/Hard

Scroll with joystick, select with
start button

VIEW BOOKKEEPING SCREEN

Batman Played	_____
Robin Played	_____
Batman Time	____:____
Robin Time	____:____
Paid Games	_____
Free Games	_____
Continued Games	_____
Games Completed	_____

SOUND OPTIONS SCREEN

SOUND #
SOUND NAME
VOLUME _____
EXIT

Changing this will change all volume

Scroll with joystick, select with
start button

COLOR ADJUSTMENT SCREEN

RED
GREEN
BLUE
BLACK
WHITE
EXIT

TROUBLESHOOTING

SYSTEM OVERVIEW:

The game consists of a RGB monitor, a Sega Titan board, a Acclaim ROM board and a Acclaim RAX Sound board. On power up you should hear one beep which signifies all boards are OK. If this is not the case or you experience problems during play refer to the following chart.

TROUBLESHOOTING CHART:

SYMPTOM	POSSIBLE CAUSES	CORRECTIONS
1. No coin-up, test, service, or button input.	A. Blown fuse or fuses. B. Bad connection C. ROM Board D. Incorrect voltage.	A. Replace fuse or fuses. B. Check harness and cable connections. Check plug to wall. C. Check to see if connectors are seated D. Check power supply voltage for 120V.
2. No sounds.	A. Volume too low. B. +12V fuse blown. C. Bad connection on Sound Board D. Titan PCB failure	A. Turn up volume via BATMAN™ FOREVER Volume Adjust screen B. Replace fuse. C. Check cable connections to J2 & J6.. D. Refer to Titan PCB Troubleshooting section below
3. Marquee is dim or dark.	A. One or both bulbs are burned out B. Wires are loose.	A. Replace with 40W incandescent bulbs. B. Check wire nuts at light sockets.
4. Colors are not correct and appear in odd patterns.	A. Monitor has become magnitized.	A. Degauss the monitor.
5. Batman or Robin don't respond correctly to controls	A. Connections on joystick and/or play buttons are loose.	A. Tighten all connections. Check switches with a meter and replace if necessary.
6. One long tone followed by 1-4 short tones.	A. Bad SRAM on Sound Board.	A. Replace U37, U38
7. Two long tones.	A. Bad EPROM on Sound Board.	A. Check socket. B. Replace U52
8. Three long tones followed by 1-4 short tones.	A. Bad U48 ROM on Sound Board.	A. Check U48 socket. B. Replace U48.
9. Three long tones followed by 5-8 short tones.	A. Bad U49 ROM on Sound Board.	A. Check U49 socket. B. Replace U49.
10. Four long followed by 1-4 short tones.	A. Bad U50 ROM on Sound Board.	A. Check U50 socket. B. Replace U50.
11. Four long tones followed by 5-8 short tones.	A. Bad U51 ROM on Sound Board.	A. Check U51 socket. B. Replace U51.

TROUBLESHOOTING, continued

SEGA TITAN PCB TROUBLESHOOTING

The TITAN PCB is a microprocessor-based board that contains the circuitry for the game inputs and outputs. Make sure the power is OFF when removing or reseating any connectors or socketed IC's.

1. Check the red LED on the board.
2. Visually check the PCB for any unseated socketed components.
3. Visually check the PCB for any burned or charred components.
4. Check the Jamma connector for a secure fit.
5. If after checking the above, your board is still not working, call your local distributor about replacing the board.

SPARE PARTS LIST

ELECTRICAL

HRD200092	Coin Counter
HRD200666	40W Clear Incandescent Bulb
HRD200668	Light Fixture, Dual
HRD201600	Speaker, 4 ohm, 50W, 5 1/4"
OEM190100	Monitor, 25" RGB
OEM190124	Joystick, 8 Way
OEM190125	Coin Door, Double Mini Frame
PS160051	Power Supply
SWT140007	Red Test Button
SWT140008	Green Service Button
SWT140019	Push-button Switch, 1 Player
SWT140020	Push-button Switch, 2 Player
SWT140050	Push-button Switch, Yellow
WIR180061	Power Cord

DECALS

CUS252250	Marquee
CUS252251	Control Panel
CUS252252L	Left Side
CUS252252R	Right Side
CUS252253	Switch Panel
CUS252254	Game Header
CUS252258	Bezel, Inner Monitor
CUS252259	Bezel, Outer Monitor

MECHANICAL & HARDWARE

CUS252255	Marquee Plastic, Inner
CUS252257	Glass
CUS252263	Marquee Plastic, Outer
CUS252265	Owner's Manual
CUS252270	Threaded Rod
CUS252273	Top Panel
CUS252274	Door, Upper Rear
CUS252275	Door, Lower Rear
CUS252282	Bracket, ROM Board
HRD200764	Grill, Speaker

PC BOARD ASSEMBLIES

OEM190128	Sega Controller Board
FB800095	RAX Main Sound Board
FB800096	Titan ROM Board

APPENDIX A

ASSEMBLIES

- Figure 2 PCB Layout
Figure 3 Overall Cabinet Assembly

HARNESSES

- CUS 252290 Harness, Jamma M350
CUS 252291 Harness, Player 1 Control Panel M350
CUS 252292 Harness, Player 2 Control Panel M350
CUS 252293 Harness, Service Panel with Meter M350
CUS 252295 Harness, AC Power M350
CUS 252296 Harness, 15" 40 Pin Ribbon M350
CUS 252302 Harness, Sound M350 & M360

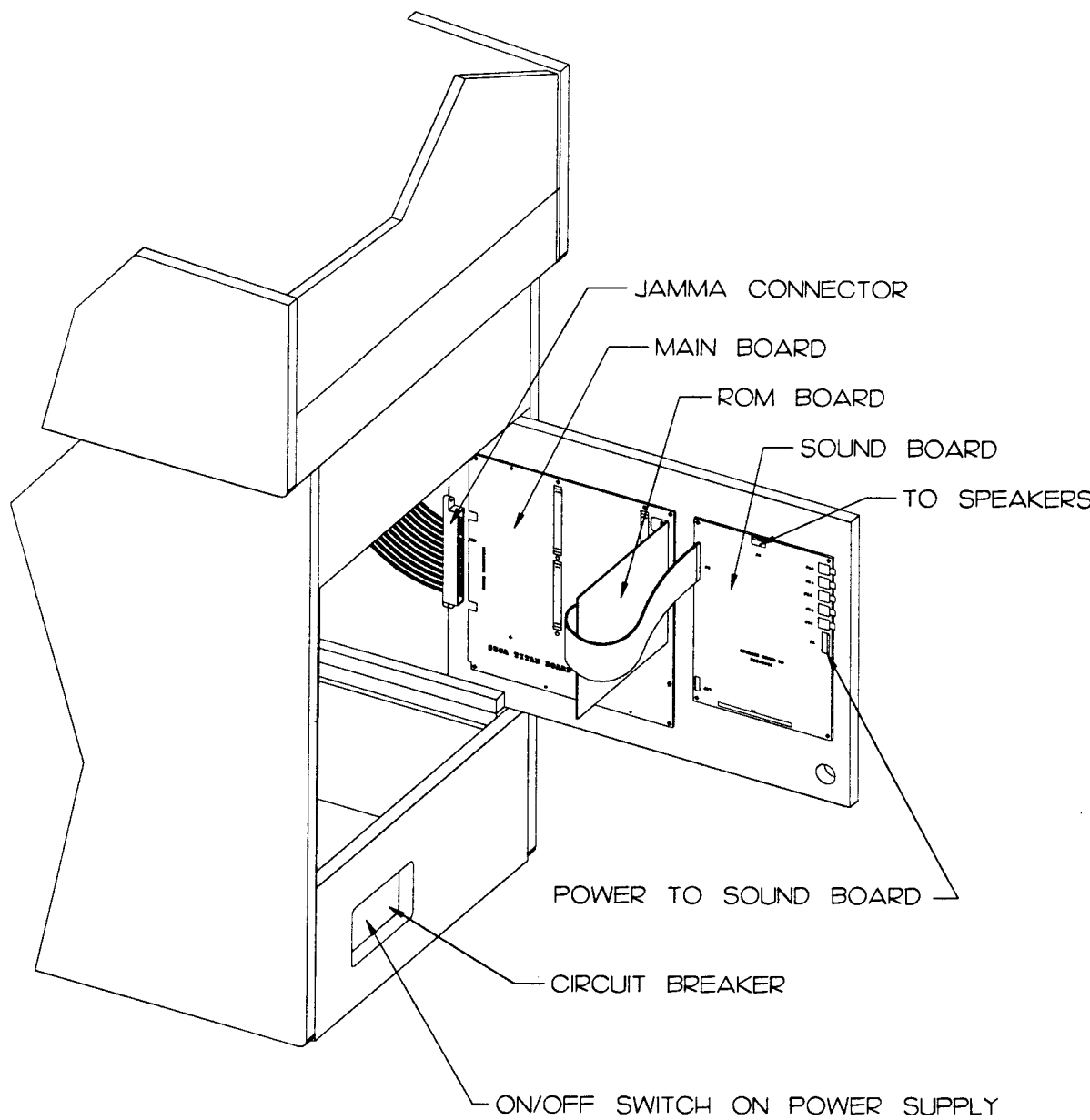

REAR OF CABINET

Figure 2

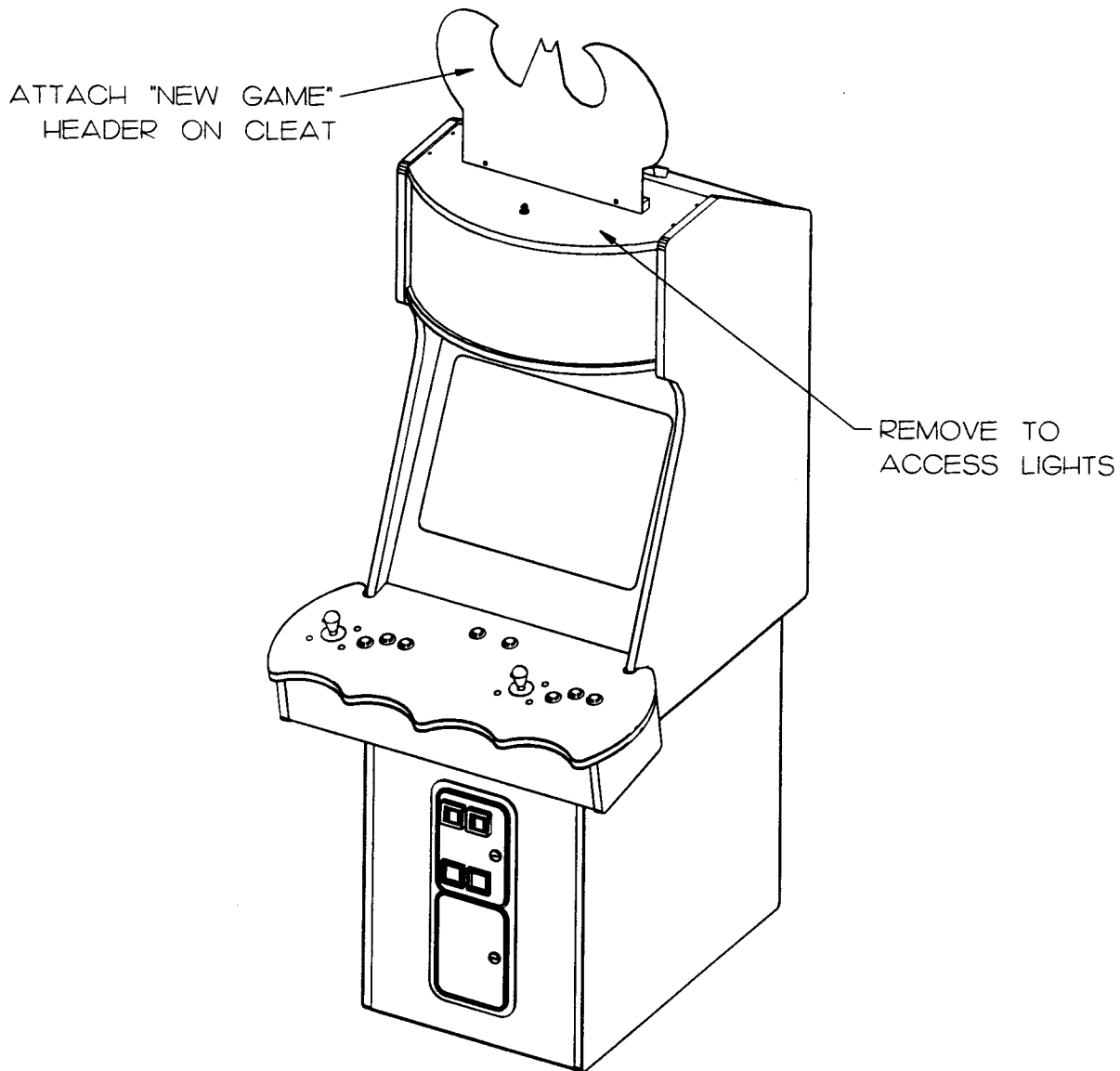

BATMAN CABINET

Figure 3

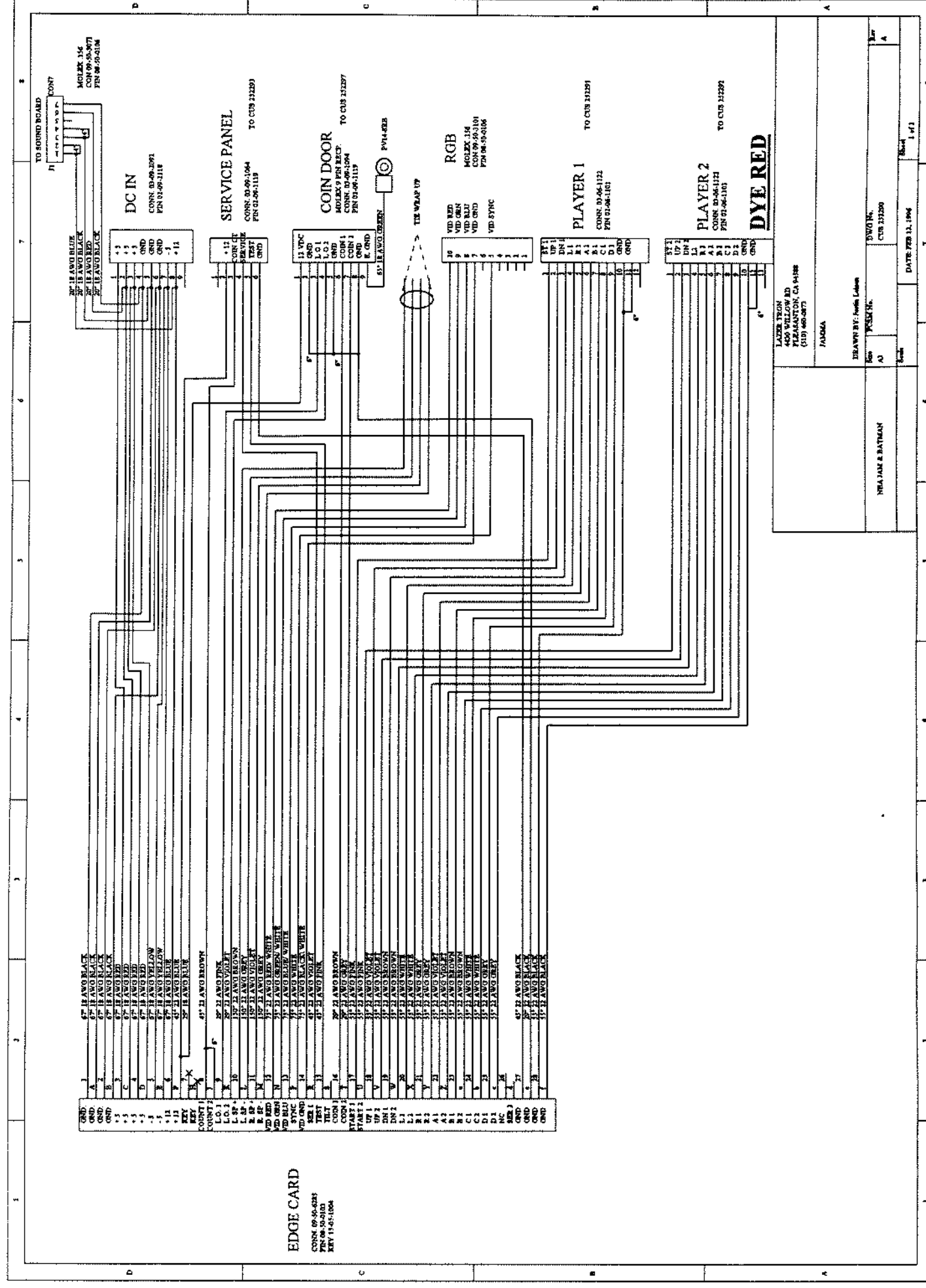

EDGE CARD
 CONS: 09-06-023
 PNC 06-00-010
 REV 14-01-104

DC IN
 CONS: 03-09-091
 PNC 01-06-118

SERVICE PANEL
 CONS: 03-09-104
 PNC 01-06-119 TO CUB 21229

COIN DOOR
 CONS: 03-09-104
 PNC 01-06-119 TO CUB 21227
 CONS: 03-09-094
 PNC 01-06-119

RGB
 MOLEX 134
 CONS: 09-06-010
 PNC 06-00-006

PLAYER 1
 CONS: 03-06-122
 PNC 01-06-103 TO CUB 21229

PLAYER 2
 CONS: 03-06-122
 PNC 01-06-103 TO CUB 21229

DYE RED

DRAWN BY: Fred Lohm
 440 WILLOW RD
 PLAZANTON, CA 91386
 (510) 465-0873
 FISHBA

DRAWING NO. DWG N.
 REV. REVISION
 PRA JAM & BATMAN
 DATE: FEB 13, 1996
 SHEET 1 OF 1

PLAYER 1
 CONN. 03-06-2122
 PIN 02-06-2101

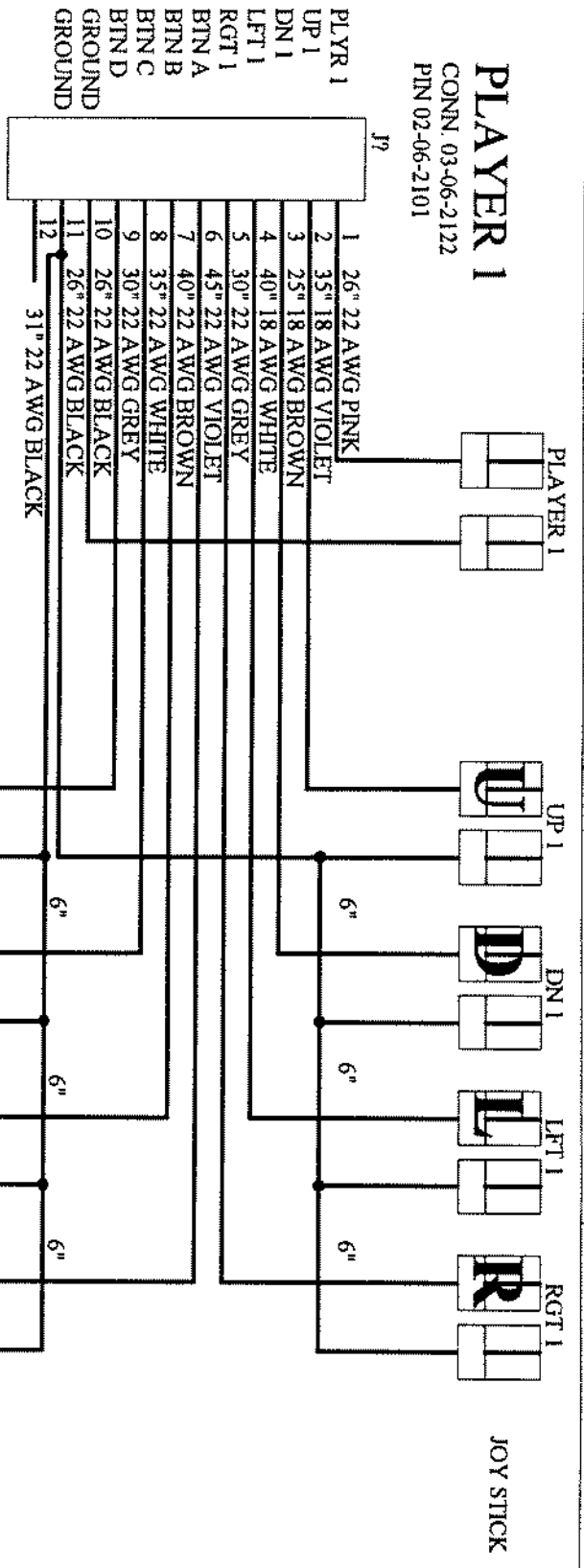

12 PIN CONN
 TO CUS 252290

NOTE:
 1) ALL SPADE CON ARE .205 / .187 X .032
 2) LABEL ALL SPADE CON.

BATMAN
 BTN A NOT USED
 BTN B JUMP
 BTN C PUNCH
 BTN D KICK

NBA JAM
 BTN A SHOOT
 BTN B PASS
 BTN C TURBO
 BTN D EXTREME

LAZER TRON
 4430 WILLOW RD
 PLEASANTON, CA 94588
 (510) 460-0873

PLAYER 1 CONTROL PANEL HARNESS
 DRAWN BY: Justin Leinen

A NBA JAM & BATMAN

Size A
 FCSM No.
 DWG No. CUS 252291

Scale
 DATE: FEB 23, 1996
 Sheet 1 of 1
 Rev B

PLAYER 2

CONN: 03-06-2122
PIN 02-06-2101

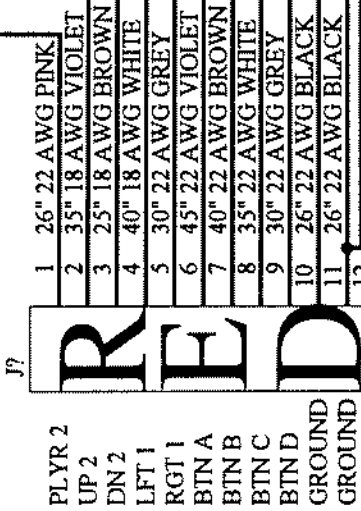

12 PIN CONN
TO CUS 252290

DYE RED

NOTE:

- 1) AL SPADE CON ARE .205 / .187 X .032
- 2) LABEL ALL SPADE CON.

BATMAN

- BTN A NOT USED
- BTN B JUMP
- BTN C PUNCH
- BTN D KICK

NBA JAM

- BTN A SHOOT
- BTN B PASS
- BTN C TURBO
- BTN D EXTREME

LAZER TRON
4430 WILLOW RD
PLEASANTON, CA 94588
(510)460-0873

PLAYER 2 CONTROL PANEL HARNESS

DRAWN BY: Justin Leinen

Size	FCSM No.	DWG No.	Rev
C		CUS 252292	B

Scale	DATE: FEB 23, 1996	Sheet
		1 of 1

CONN. 03-09-2062
PIN 02-09-2118

USE WIRES OFF OF METER

COIN
METER

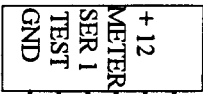

1
2 8" 18 AWG BLACK
3 8" 18 AWG BLACK
4 10" 22 AWG VIOLET
5 6" 22 AWG PINK
6 6" 22 AWG BLACK

TO CUS 252290

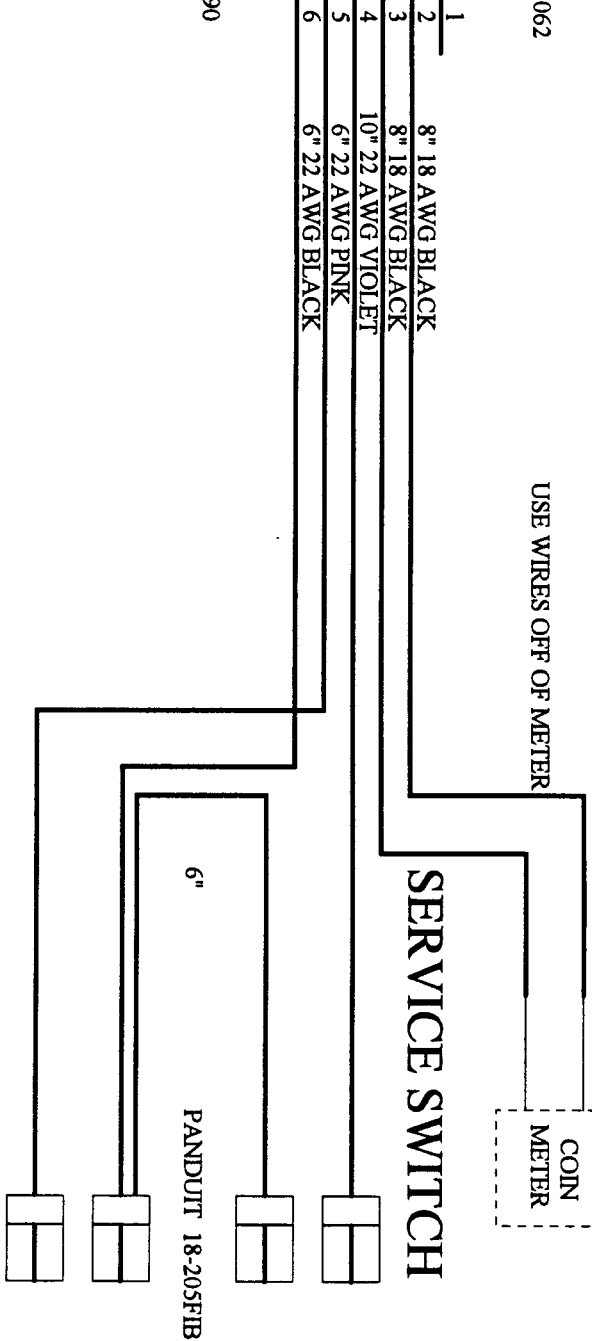

SERVICE SWITCH

PANDUIT 18-205FIB

TEST SWITCH

LAZER TRON
4430 WILLOW ROAD
PLEASANTON, CA 94588
(510) 460-0873

SERVICE PANEL HARNESS

DRAWN BY: Justin Leinen

NBA JAM & BATMAN

Size A
FCSM No.

DWG No.
CUS252293

Rev
A

DATE: FEB 12, 1996

Sheet
1 of 1

1

2

3

4

1

2

3

4

AC IN

CONN. 03-09-2032
PIN 02-09-2116

- 1 100" BLACK 18 AWG
- 2 100" GREEN 18 AWG
- 3 100" WHITE 18 AWG

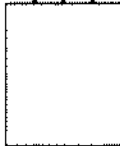

- 1 50" BLACK 18 AWG
- 2 50" GREEN 18 AWG
- 3 50" WHITE 18 AWG



MONITOR AC

CONN. 1-480700-0
PIN 350547-1



STRIP 1/2 INCH

LIGHT AC

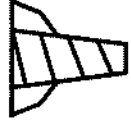

LAZER TRON
4430 WILLOW ROAD
PLEASANTON, CA 94588
(510) 460-0873

AC PWR

DRAWN BY: Justin Leinen

Size
A

FCSM No.

DWG No.
CUS 252295

Rev
A

Scale

Sheet

1 of 1

UP	1		UP
	2		1
	3		2
	4		3
	5		4
	6		5
	7		6
	8		7
	9		8
	10		9
	11		10
	12		11
	13		12
	14		13
	15		14
	16		15
	17		16
	18		17
	19		18
	20		19
	21		20
	22		21
	23		22
	24		23
	25		24
	26		25
	27		26
	28		27
	29		28
	30		29
	31		30
	32		31
	33		32
	34		33
	35		34
	36		35
	37		36
	38		37
	39		38
	40		39
40PIN			40PIN

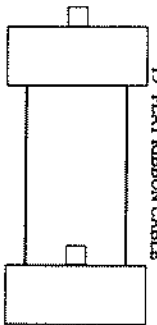

CONNECTOR, 40 PIN DIP, 0.10", WITH POLARIZING TAB

LAZER TRON
 4430 WELLOW ROAD
 PLEASANTON, CA 94588
 (510) 460-0873

15° 40 PIN RIBBON CABLE

DRAWN BY: Justin Letinen

NBA JAM & BATTMAN		Scale	
Size A	PCSM No.	DWG No. CUS252296	Rev B
DATE: FEB 21, 1996		Sheet 1 of 1	

MOLEX 9 PIN PLUG
 CON 03-09-2092
 PIN 02-09-2118

J7

- 1 29" 22 AWG BLUE
- 2 30" 22 AWG BLACK
- 3 18" 22 AWG PINK
- 4 22" 22 AWG VIOLET
- 5 18" 22 AWG BLACK
- 6 38.25" 22 AWG BROWN
- 7 40.25" 22 AWG GREY
- 8 38.25" 22 AWG BLACK
- 9 25" 22 AWG GREEN

9 PIN CONN

TO CUS 252290

8" LENGTH CLEAR PVC OR SPLIT CORRUGATED
 LOOM TUBING OVER THIS LENGTH

RING LUG

PN18-610R #8

PANDUIT DNF 18-110FIB

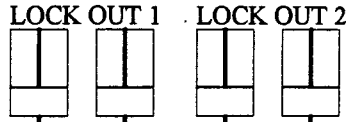
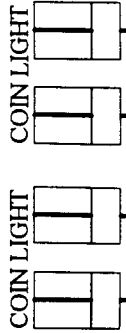

COIN SWT 1

COIN SWT 2

PANDUIT DNF 18-205FIB

HARNES BIULT BY COIN CONTROL MOUNTED IN COIN DOOR

LAZER TRON
 4430 WILLOW ROAD
 PLEASANTON, CA 94588
 (510) 460-0873

COIN DOOR HARNESS

DRAWN BY: Justin Leinen

Size A

FCSM No.

CUS252297

Rev

I

Scale

Sheet

DATE: JAN 10, 1996

1 of 1

BATMAN™ FOREVER KIT INSTALLATION

Refer to the previous sections of this manual for safety warnings, on screen menus, and troubleshooting of your BATMAN™ FOREVER game.

Acclaim ... SERIOUS COIN!

Sales: Acclaim Coin-operated entertainment, inc., 2593 Coast Avenue, Mountain View, CA 94943

(415) 528-2100 phone, (415) 528-2185 fax

Customer Service: Lazer-tron Corp., 4430 Willow Road, Pleasanton, CA 94588

(510) 460-0873 phone, (510) 460-0365 fax

P/N CUS252265 Rev A

Copyright © 1996 Acclaim entertainment, inc.

KIT PARTS LIST

<u>PART #</u>	<u>DESCRIPTION</u>	<u>QUANTITY</u>
HARNESSES		
CUS252287	Harness, Player 1 Control Panel	1
CUS252288	Harness, Player 2 Control Panel	1
CUS252289	Harness, JAMMA Kit	1
CUS252295	Harness, AC Power	1
CUS252296	Harness, 15" Ribbon	1
CUS252302	Harness, Sound	1
ARTWORK/DECALS		
CUS252254	Game Header	1
CUS252410	Decal, Buttons & Logos	1
CUS252411	Decal, Bezel	1
CUS252412	Decal, Control Panel	1
CUS252413	Decal, Marquee Insert	1
CUS252414	Decal, Side	2
CUS252429	Decal, Plain Black	1
CONTROL PANEL PARTS		
CUS252264	Pattern, Button Layout	1
HRD200824	Nut, 10-24 Kep	8
HRD201140	Bolt, 10-24 x 1 1/2" Black Carriage	8
OEM190124	Joystick	2
SWT140019	Pushbutton, One Player	1
SWT140020	Pushbutton, Two Player	1
SWT140050	Playbutton, Yellow	6
ELECTRONICS		
CUS252282	Bracket, SEGA ROM Board	1
FB800095	RAX Sound Board	1
FB800096	ROM Board	1
HRD200744	Screw, 6-32 x 3/8" PPH	2
HRD200809	Nut, 6-32 Kep	2
OEM190128	SEGA Controller Board	1
CUS252265	Manual	1

INSTALLATION INSTRUCTIONS

WARNING!! UNPLUG YOUR GAME BEFORE BEGINNING THIS INSTALLATION. FAILURE TO DO SO MAY RESULT IN INJURY TO YOURSELF AND/OR YOUR GAME.

ESD PRECAUTIONS!! The printed circuit boards in this kit are sensitive to electro-static discharge. Your body is capable of transferring enough current to damage components on the boards. To avoid this, wear a proper grounding strap or take necessary precautions before handling any of the printed circuit boards.

SPECIFICATIONS AND REQUIREMENTS

Power Supply Requirements

Minimum:

150W, +12VDC @ 4 amps, +5VDC @ 5 amps

For the best performance and sound we recommend:

200V, +12V @ 8 amps, +5VDC @ 20 amps.

Shipping Specifications

Size: 28 x 16 x 9

Weight: 14 pounds

PREPARING THE GAME CABINET

1. Unplug all harnesses from printed circuit boards, joysticks, pushbuttons, and other devices.
2. Remove printed circuit boards.
3. Remove buttons and joysticks from control panel.
4. Remove all old decals, overlays, and outer monitor bezel.
5. Clean all surfaces thoroughly with a good surface cleaner. Surfaces receiving new decals should also be cleaned with a degreaser like denatured alcohol.

ADDING NEW HOLES TO THE CONTROL PANEL

1. Cut the **BUTTON & JOYSTICK PATTERN**, #CUS252264 in half where shown to make two full-sized patterns.
2. Using the 1/8 scale drawing included on the pattern, locate each button layout as shown on your panel. This is a suggested spacing to give a comfortable distance between the players. Adjust as necessary for your particular cabinet.
3. Center punch the location of new holes and drill or punch the joystick positions to 1.25" diameter and all six play buttons to 1.12" diameter.
4. Locate and drill 2, 1.12" diameter holes approximately where shown for the 1 Player and 2 Player Start buttons.
5. If you will be using a clear plastic cover, cut those holes to match the control panel pattern.
6. Plug or fill any unused holes if desired.

INSTALLATION INSTRUCTIONS, continued

INSTALLATION OF:

Control Panel

1. The kit Control Panel decal is oversized to fit most 2 player games. Remove the backing and apply centered on your control panel. Take care to smooth out any bubbles as you press down firmly from the center out to the edges.
2. Trim excess from the edges.
3. Cut out the holes using the control panel as a guide for your knife.

4. Remove the backing from the words "JUMP", "PUNCH", & "KICK" and apply as shown on the pattern drawing. Leave enough clearance for the button bezel overlap.
5. Apply the Player 1 and Player 2 labels if desired. These are not necessary since the buttons are screened with characters.
6. If you will be using a plastic cover, install it now and cut holes to match.
7. Install the buttons and joysticks in their appropriate holes. Install the 1 Player button on the left-hand side of the Control Panel and the 2 Player button on the right.

Printed Circuit Boards

8. Mount the printed circuit boards on the inside of the game cabinet. An arrangement similar to figure 2 is recommended although the sliding tray is not needed.
9. Connect harnesses according to the Wiring Diagrams on the following pages.

Cabinet Decals & Bezel

10. Apply a large (6" x 16 1/2") Acclaim logo decal and a side BATMAN™ FOREVER decal to each side.
11. Apply one of the wedge shaped Acclaim decals to each side of the control panel.
12. Apply the coin/test/service decal next to your existing controls. Cut the decal into pieces if necessary to fit your arrangement. For the purposes of this game, the test button is red and the service button is green.
13. Cut the monitor bezel to fit your existing monitor and install with double backed tape in place of your old one.
14. Screw the "New Game" marquee to the top of the cabinet. If there is no cleat on the cabinet top attach one 16" long.
15. Install the backlit marquee in place of your old marquee. Trim to fit if necessary. Two 40 watt incandescent bulbs are recommended to light the marquee area.
16. Save any extra decals for future needs.

THE GAME IS NOW READY TO TURN ON AND TEST. To enter the Test Mode and On Screen Menus. press the red Test button anytime after power up. Turn now to the screen menus section in the beginning of this manual for further information.

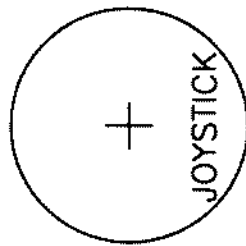
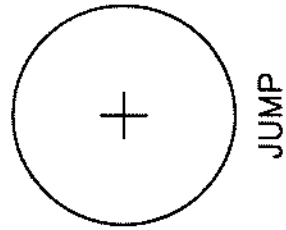
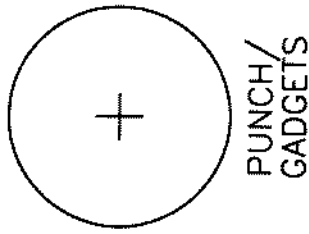
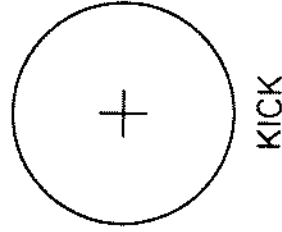
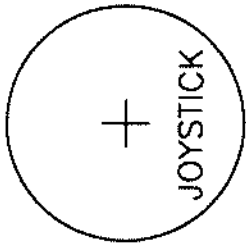
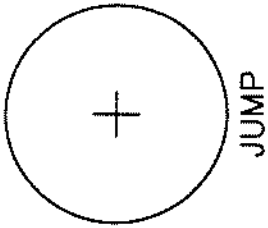
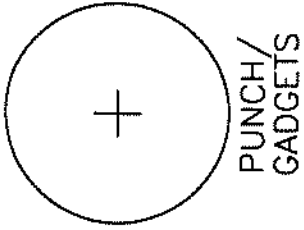
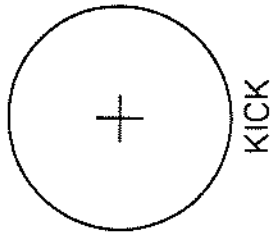

CUT HERE FOR 2 PATTERNS

CUT HERE FOR 2 PATTERNS

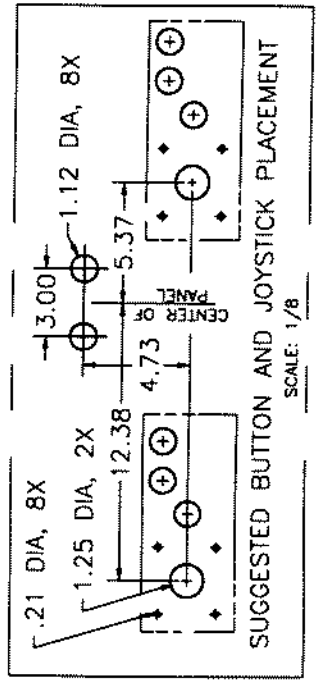

BUTTON & JOYSTICK LAYOUT, 1/1 SCALE

PLAYER 1

CONN. 03-06-2122
PIN 02-06-2101

J?

PLYR 1
UP 1
DN 1
RGT 1
LFT 1
BTN A
BTN B
BTN C
BTN D
GROUND
GROUND

- 1 50" 22 AWG PINK
- 2 50" 18 AWG VIOLET
- 3 50" 18 AWG BROWN
- 4 50" 18 AWG WHITE
- 5 50" 22 AWG GREY
- 6 50" 22 AWG VIOLET
- 7 50" 22 AWG BROWN
- 8 50" 22 AWG WHITE
- 9 50" 22 AWG GREY
- 10 50" 22 AWG BLACK
- 11 50" 22 AWG BLACK
- 12 50" 22 AWG BLACK

12 PIN CONN
TO CUS 252263

PLAYER 1

JOY STICK

BUTTONS

UP 1 RGT 1 LFT 1

BTN D BTN C BTN B BTN A

NOTE:
1) AL SPADE CON ARE .205 / .187 X .032

LAZER TRON
4430 WILLOW RD
PLEASANTON, CA 94588
(510) 460-0873

PLAYER 1 CONTROL PANEL HARNESS KIT

DRAWN BY: Justin Leinen

Size
A

FCSM No.

DWG No.
CUS 252287

Rev
A

Scale

DATE: JAN 10, 1996

Sheet

1 of 1

PLAYER 2

CONN. 03-06-2122
PIN 02-06-2101

1 2 3 4
PLAYER 2 UP 2 DN 2 RGT 2 LFT 2

JOY STICK

R
E
D

- 1 50" 22 AWG PINK
- 2 50" 18 AWG VIOLET
- 3 50" 18 AWG BROWN
- 4 50" 18 AWG WHITE
- 5 50" 22 AWG GREY
- 6 50" 22 AWG VIOLET
- 7 50" 22 AWG BROWN
- 8 50" 22 AWG WHITE
- 9 50" 22 AWG GREY
- 10 50" 22 AWG BLACK
- 11 50" 22 AWG BLACK
- 12 50" 22 AWG BLACK

12 PIN CONN
TO CUS 252298

DYE RED

BTND BTN C BTN B BTN A

BUTTONS

NOTE:
1) AL SPADE CON ARE .205 / .187 X .032

LAZER TRON
4430 WILLOW RD
PLEASANTON, CA 94588
(510)460-0873

PLAYER 2 CONTROL PANEL HARNESS KIT

DRAWN BY: Justin Leinen

Size C

FCSM No.

DWG No.

CUS 252288

Rev A

DATE: JAN 22, 1996

Sheet 1 of 1

1

2

3

4

A

B

C

D

A

B

C

D

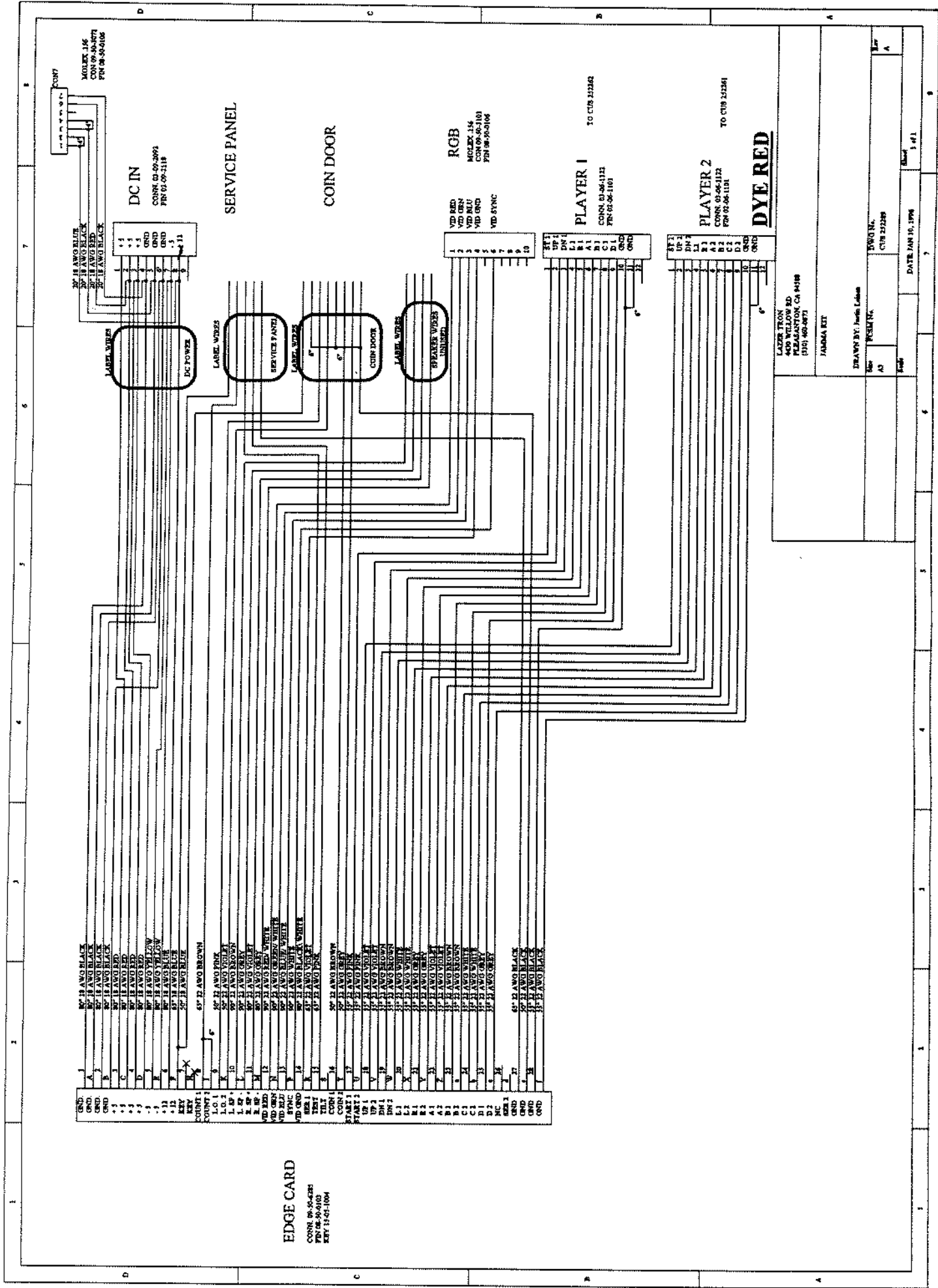

MOLEX 146
CONN. 01-06-1072
P/N 01-06-1018

DC IN
CONN. 01-06-2093
P/N 01-06-2118

SERVICE PANEL

COIN DOOR

ROB
MOLEX 214
CONN. 01-06-1101
P/N 01-06-1018

PLAYER 1
CONN. 01-06-1122
P/N 01-06-1101

PLAYER 2
CONN. 01-06-1122
P/N 01-06-1101

DYE RED

LAZER TRON
400 WELLOW RD
MERRINGTON, CA 94188
(510) 460-0873

FABRIMA KIT

DESIGNED BY: James Collins

Rev: A3

DATE: JAN 10, 1978

1 of 1

EDGE CARD
CONN. 01-06-4283
P/N 01-06-50103
REV. 12-01-1004

AC IN

CONN. 03-09-2032
PIN 02-09-2116

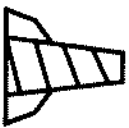

STRIP 1/2 INCH

LIGHT AC

- 1 100" BLACK 18 AWG
- 2 100" GREEN 18 AWG
- 3 100" WHITE 18 AWG

- 1 50" BLACK 18 AWG
- 2 50" GREEN 18 AWG
- 3 50" WHITE 18 AWG

MONITOR AC

CONN. 1-480700-0
PIN 350547-1

LAZER TRON
4430 WILLOW ROAD
PLEASANTON, CA 94588
(510) 460-0873

AC PWR

DRAWN BY: Justin Leinen

NBA JAM & BATMAN

Size
A

FCSM No.

DWG No.
CUS 252295

Rev
A

Scale

DATE: FEB 12, 1996

Sheet

1 of 1

1

2

3

4

1

2

3

4

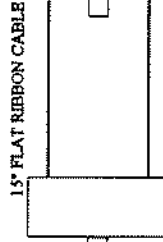
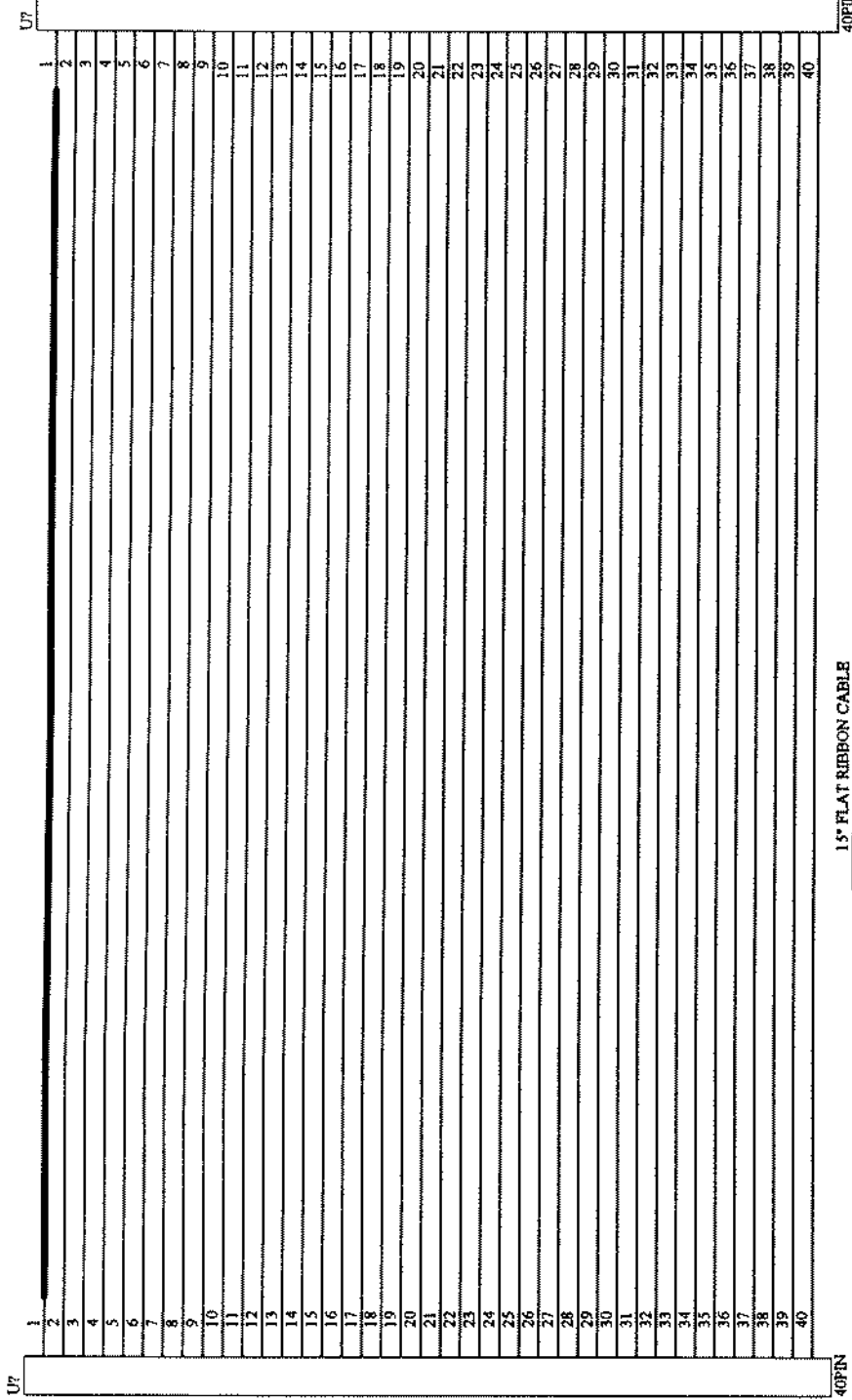

15" FLAT RIBBON CABLE

CONNECTOR, 40 PIN DEP. 0.10", WITH POLARIZING TAB

LAZER TRON
4430 WILLOW ROAD
PLEASANTON, CA 94588
(510) 460-0873

15" 40 PIN RIBBON CABLE

DRAWN BY: Justin Leinen

Size
A

FCSM No.

DWG No.
CUI252296

NBA JAM & BATMAN

Scale

DATE: FEB 21, 1996

Sheet
1 of 1

1 2 3 4

CONN. 09-50-3051
PIN 08-50-0106

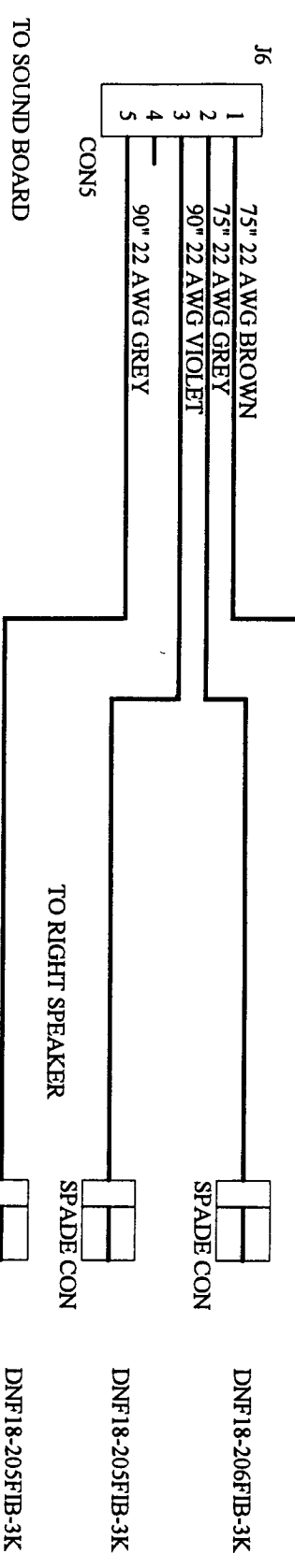

LAZER TRON
4430 WILLOW RD
PLEASANTON, CA 94588
(510)460-0873

SOUND HARNESS NBA-JAM

DRAWN BY: Justin Leinen

NBA JAM & BATMAN

A

B

C

D

Size	FCSM No.	DWG No.	Rev
C		CUS 252302	B

Scale	DATE: FEB 23, 1996	Sheet
		1 of 1

1 2 3 4

A

B

C

D