

namco[®]

MARIO KART



OPERATORS MANUAL

IT IS THE RESPONSIBILITY OF THE OPERATOR TO MAINTAIN CUSTOMER SAFETY
AT ALL TIMES, AND IT IS IMPERATIVE THAT THE DETAILS SET OUT IN THIS MANUAL
ARE FOLLOWED PRECISELY

Contents

OPERATORS MANUAL	1
GENERAL SAFETY CONSIDERATIONS	4
ALLGEMEINE SICHERHEITSHINWEISE	6
GENERELLE SIKKERHEDSOVERVEJELSER	8
CONSIDERACIONES GENERALES DE SEGURIDAD.	10
CONSIGNES GENERALES DE SECURITE	12
ΕΞΕΤΑΣΗ ΓΕΝΙΚΗΣ ΑΣΦΑΛΕΙΑΣ	14
CONSIDERAZIONI GENERALI SULLA SICUREZZA	16
VANLIGE SIKKERHETSTILTAK	18
ALGEMENE VEILIGHEIDSOVERWEGINGEN	20
AVISOS DE PERIGO	22
ALLMÄNNA SÄKERHETSBEAKTANDEN	24
YLEISET TURVALLISUUNÄKÖKODAT	26
1. SPECIFICATIONS	28
2. MAIN COMPONENTS	29
3. HOW TO PLAY	30
4. MOVING THE MACHINE	33
5. INSTALLATION	33
5-1 Removing the Header Assy	37
5-2 Fitting the Seat Base Assemblies.	38
5-3 Linking Two Cabinets	39
5-4 Game Initialization	40
5-5 Adjusting the Level Adjuster	41
6. ADJUSTMENTS	42
6-1 Adjustment Switches	43
6-2 Test Mode	44
6-2-1 Coin Assignment	45
6-2-2 Clock Setting	47
6-2-3 Network Setting	47
6-2-4 Game Test Menu	48
6-2-4-1 Game Options	49
6-2-4-2 I/O Test	50
(a) GO TO [I/F] INITIALIZE	50
(b) Switch Test	51
(c) Lamp Test	52
(d) Camera Check	53
Namcam2 camera adjustment method	54
6-2-4-3 Monitor Test	55
6-2-4-4 Sound Setting	56
6-2-4-5 Setting the Business Closing Time (CLOSE SETTING)	57
6-2-4-6 Book Keeping	58
6-2-4-7 Others	59

7.	MAINTENANCE	60
7-1	Self Test	62
7-2	Error Displays	63
7-2-1	Errors related to the Steering Assy.	63
7-2-2	Errors related to the Camera Assy.	64
7-2-3	Errors related to Communications.	64
7-3	Replacing the Fluorescent Tube	65
7-4	Replacing the Pushbutton Switches	66
7-5	Replacing the Camera Assy	68
7-6	Replacing the Steering PC Board Fuse	70
7-7	Removing the Steering PC Board	71
7-8	Removing the Steering Assy	72
7-9	Replacing the Steering Potentiometer	73
7-10	Replacing the Steering Motor or Drive Belt	74
7-11	Removing the Steering Wheel	75
7-12	Removing the Pedal Assy	76
7-12-1	Replacing the Pedal Potentiometer	77
7-13	Removing the Monitor	78
7-14	Removing the FCA PC Board	81
7-15	Removing the TRIFORCE PC Board	82
7-16	Removing the Sound PC Boards	83
8.	PARTS	84
8-1	Monitor Cabinet	84
8-2	Seat Base Assembly	86
8-3	Header Assembly	87
8-4	Steering Assembly	88
8-5	Accelerator/Brake Pedal Assembly	89
8-6	Service Bracket Assembly	90
9.	DISPOSAL OF THE MACHINE	91
10.	SCHEMATIC	92



No part of this publication may be reproduced by any mechanical, photographic or electronic process, or in the form of phonographic recording, nor may it be stored in a retrieval system, transmitted or otherwise copied for private use, without permission from **NAMCO EUROPE LIMITED**.

While the information contained in this manual is given in good faith and was accurate at the time of printing, NAMCO EUROPE LIMITED reserve the right to make changes and alterations without notice.

This equipment has been manufactured in accordance with European Directives, and has been tested and complies with the directives 89/336/EEC and 72/23/EEC by the application of EN55014-1, EN55014-2 and EN60335-2-82 standards and as such bears the CE marking. Any changes or modifications to this equipment must be in accordance with the European Directives. Any unauthorised changes to this equipment may contravene such directives.

Under some conditions of extreme external interference, e.g. radio transmissions, electrostatic discharge or mains born transients, some degradation of performance may occur. However the equipment will recover normal performance once the source of interference has ceased or been removed.

Following abnormally high surges on the mains supply, the video monitor may need to be manually reset by turning the equipment OFF and back ON.

If the game processor resets due to an interruption of the mains voltage, any credits established will be lost.

This equipment is not a machine as defined by the machinery directive 89/392/EEC.

SAFETY WARNING

In order to use this equipment safely, be sure to read this Operators Manual carefully before installation, adjustment or use of this equipment.

Whenever the owner of this equipment entrusts dis-assembly, installation, adjustment or routine maintenance to another person, the owner should ensure that that person read the appropriate precautions and relevant sections of this manual before starting work.

In order that no accidents occur when the equipment is in operation, strictly follow the notes on safety as described below.

This manual along with the Installation Manual (where applicable) form an integral part of the equipment and must be available to the operating or service personnel at all times.

This equipment is for indoor use only and should only be used for the purpose intended.

Namco Europe Ltd. bears no responsibility for accidents, injury or damage resulting from unauthorized changes to, or improper use of this equipment.











SAFETY NOTES

The following safety notes are used throughout this manual. Familiarize yourself with each of these notes and it's meaning before installing, servicing or making adjustments to this equipment.

WARNING  Warning denotes a hazard that could result in injury or death. Do not proceed beyond a warning note until the indicated conditions are fully understood and met.

CAUTION  Caution denotes a hazard that could result in damage to the equipment. Do not proceed beyond a caution note until the indicated conditions are fully understood and met.

GENERAL SAFETY CONSIDERATIONS

-  **Only operate this equipment after checking that it has been installed correctly and in accordance with this manual.**
-  **Parts of this equipment move during game play, so there are places where the distance between the stationary section and moveable section changes. There are warning notices to keep hands and feet clear of moving parts, however if the operator feels that a person is in any danger, he should warn that person accordingly.**
-  **The warning notices must always be kept in good condition and replaced if worn, so that customers can read them clearly.**
-  **Installation, service, adjustment or routine maintenance should be carried out by suitably qualified persons only.**
-  **For continued protection against fire hazard, replace fuses with the same type and rating. The use of other fuses or material is prohibited.**
-  **The power supply inside the monitor will remain hot and have areas of high voltage even though the equipment has been tuned OFF, and there is the possibility of burns or electric shock. Be careful not to touch these areas.**
-  **To prevent possible electric shock due to failure, this equipment **MUST** be fitted with a securely connected EARTHED plug.**
-  **If at any time the mains lead becomes damaged, it must be replaced immediately.**
-  **Do not turn the power switch ON until the equipment has ben installed correctly.**
-  Before connecting the machine to the mains supply, ensure that the equipment is set for the correct voltage and that the correct fuse are fitted.

NOTES ON INSTALLATION



NEVER turn the power to the machine **ON** until installation has been completed.



In order to prevent possible electric shocks, be sure that the equipment is connected to the mains with a securely connected earthed plug.



So that customers are not injured by the movement of the equipment, ensure that there is at least 500mm separation between other equipment or walls.



In order to avoid damage to the equipment due to mis-operation, ensure that the voltage of the mains supply is 230volts AC.

Note: If the location of this equipment has a polished floor, it is recommended that rubber pads are fitted under the level adjusters to prevent the equipment sliding on the floor when in use.

Note: In order to gain access to the Power Supply and CPU assemblies, ensure that the rear of the equipment is separated from a wall or other equipment by at least 500mm

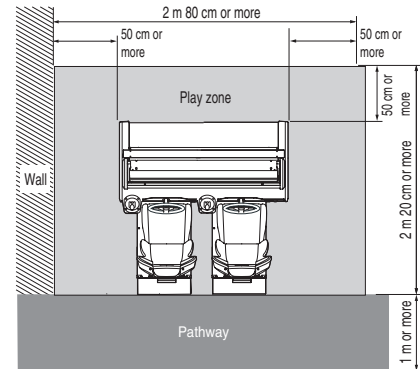

MOVING THE EQUIPMENT



This equipment is fitted with castors to make it easier to move. Take care when moving the equipment on an inclined surface.



The Header Assembly has a forward centre of gravity, so it is important that at least **two people** are used to fit or remove the Header Assembly.



The fitting position of the Header Assembly is high, and it is important that a means of reaching the height safely, without stretching, is available. (e.g. Steps, Step Stool etc.)



The overall height of the equipment, with the Header Assembly fitted, is 2050mm. Take care of any overhead obstructions. (e.g. Light Fittings, Electric Cables etc.)

REMOVING AND REPLACING PARTS



Adjustments or maintenance on this equipment should be carried out by suitably qualified personnel only.



Do not make any alteration to this equipment without prior approval. Doing so could cause unforeseeable danger.



Only parts specified by Namco Europe Ltd. should be used when replacing parts. (Including screws)



Ensure that the power to the equipment is turned OFF before commencing any maintenance work. (Trouble shooting, repairs etc.)



If performing work not described in this manual, contact your distributor for instructions, as no responsibility will be accepted for damage or injury.



Parts of the Power Supply and Monitor remain hot and carry high voltage even after switching OFF and could cause burns or electric shock. Take care not to touch these parts accidentally.



Make sure that the equipment is switched OFF before connecting or disconnecting any plugs or connectors.



When moving the mains connector from the equipment, or the mains plug from the wall outlet, always grasp the plug and not the cable.



Dieses Dokument darf in keiner Weise vervielfältigt werden. Jegliche Tonaufnahmen sowie die Speicherung auf Datenträger (Suchsysteme), die Weitergabe oder sonstiges Kopieren für den gewerblichen und privaten Gebrauch sind untersagt und bedürfen der vorherigen Genehmigung durch NAMCO EUROPE LIMITED.

Die Informationen in diesem Handbuch entsprechen den Tatsachen bei Drucklegung. NAMCO EUROPE LIMITED behält sich jedoch das Recht zu Änderungen ohne vorherige Bekanntgabe vor.

Dieses Gerät trägt das CE-Zeichen und wurde gemäß den EU-Richtlinien produziert. Es erfüllt die Richtlinien 89/336/EEC und 72/23/EEC und Standards EN 55014-1, EN55014-2 und EN60335-2-82 (s. Deckblatt des Handbuchs). Alle Veränderungen an diesem Gerät müssen in Übereinstimmung mit den EU-Richtlinien erfolgen. Nicht genehmigte Veränderungen an diesem Gerät verstoßen gegen diese Richtlinien.

Extreme äußere Störungen, wie z.B. durch Radiobetrieb, elektrostatische Entladung oder zeitweilige Netzschwankungen können zu einer Leistungsminderung führen. Sobald diese Faktoren jedoch ausgeschaltet oder beseitigt wurden, erreicht das Gerät seine normale Leistung.

Achtung! Falls der Spielprozessor auf Grund von Netzunterbrechungen oder Abnahme der Netzspannung aussetzt, kann es zum Verlust von Spielkrediten kommen.

Dieses Gerät fällt nicht unter die Maschinen-Richtlinie 89/392/EEC

SICHERHEITSHINWEISE

Um einen ordnungsgemäßen Betrieb dieses Gerätes zu gewährleisten, muß vor Aufstellung, Inbetriebnahme und Gebrauch das Handbuch sorgfältig gelesen werden.

Sobald der Besitzer dieses Gerätes die Demontage, Aufstellung, Inbetriebnahme oder den Service einer anderen Person überträgt, muß er sicherstellen, daß diese Person vor Arbeitsbeginn die nötigen Sicherheitshinweise und die dazugehörigen Kapitel des Handbuchs liest und versteht.

Um jegliche Unfälle während des Betriebes zu vermeiden, müssen obige Hinweise strikt befolgt werden.

Dieses Handbuch sowie das spezielle Geräte-Handbuch (wenn vorhanden) gehören zum Gerät und müssen dem Betreiber und Wartungspersonal stets zugänglich sein

Dieses Gerät ist ausschließlich für den gewerblichen Gebrauch in geschlossenen Räumen bestimmt und darf nur dort betrieben werden.

NAMCO EUROPE Ltd. übernimmt keinerlei Haftung für Unfälle, Verletzungen oder Beschädigungen, die auf nicht genehmigte Veränderungen oder unsachgemäßen Betrieb des Gerätes zurückzuführen sind.

SICHERHEITSHINWEISE

Folgende Sicherheitsbegriffe werden im gesamten Handbuch benutzt. Machen Sie sich daher bitte vor Inbetriebnahme, Wartung und Durchführung von Einstellungen am Gerät mit diesen Warnhinweisen vertraut.

WARNUNG  **WARNUNG bezeichnet eine Gefahrenquelle für Leib und Leben. Erscheint dieser Warnhinweis, darf erst weitergearbeitet werden, wenn die entsprechenden Erklärungen vollständig verstanden und befolgt wurden.**

VORSICHT  **VORSICHT bezeichnet eine Gefahrenquelle für die Beschädigung des Gerätes. Erscheint dieser Warnhinweis, darf erst weitergearbeitet werden, wenn die entsprechenden Erklärungen vollständig verstanden und befolgt wurden.**

ALLGEMEINE SICHERHEITSHINWEISE

 **Das Gerät darf nur betrieben werden, nachdem es vorschriftsmäßig und in Übereinstimmung mit dem Handbuch aufgestellt wurde.**

 **Das Gerät bewegt sich während des Spielbetriebes, somit verändert sich der Abstand zwischen feststehenden und beweglichen Teilen. Warnschilder verweisen darauf, für Hände und Füße einen gebührenden Sicherheitsabstand einzuhalten. Sobald eine Person in Gefahr ist, muß der Betreiber sie warnen.**

 **Die Warnschilder müssen in gutem Zustand sein und ersetzt werden, wenn sie nicht mehr gut lesbar sind.**

 **Aufstellung, Service, Einstellungen und Wartung dürfen nur von dafür qualifiziertem Fachpersonal durchgeführt werden.**

 **Zur Vermeidung von Feuer, defekte Sicherungen nur durch vorgeschriebene Sicherungen ersetzen. Die Verwendung von andersartigen Sicherungen oder unterschiedlichem Material ist untersagt.**

 **Das Netzteil im Monitor bleibt nach Ausschalten des Gerätes noch heiß und führt weiterhin Hochspannung. Daher besteht die Gefahr von Verbrennungen und Elektroschlägen. Diese Bereiche dürfen nicht berührt werden.**

 **Zur Vermeidung von Elektroschlägen muß dieses Gerät mit einem ordnungsgemäß geerdeten Netzstecker versehen sein.**

 **Bei Beschädigungen des Netzteiles muß dieses umgehend ersetzt werden.**

 **Gerät erst nach abgeschlossener Aufstellung einschalten.**

 **Vor Einstecken des Netzsteckers bitte sicherstellen, daß Netzspannung und Gerätespannung übereinstimmen, und die vorgeschriebenen Sicherungen verwendet wurden.**

HINWEISE ZUR AUFSTELLUNG



NIEMALS das Gerät einschalten bevor die Aufstellung völlig abgeschlossen ist.



Zur Vermeidung von Elektroschlägen muß das Gerät mit einem ordnungsgemäß geerdetem Netzstecker an die Stromversorgung angeschlossen werden.



Um zu vermeiden, daß Kunden durch die Gerätebewegungen verletzt werden, muß ein Sicherheitsabstand zu anderen Geräten und Wänden von mindestens 50cm eingehalten werden.



Zur Vermeidung von Beschädigungen durch Fehlbetrieb am Gerät sicherstellen, daß die Netzspannung 230 Volt beträgt.

Hinweis: Ist das Gerät für einen Aufstellplatz mit glattem Fußboden bestimmt, müssen die Standbeine mit Gummiplättchen unterlegt werden, damit das Gerät fest steht und nicht auf dem Boden hin- und herrutscht.

Hinweis: Zu Reparaturzwecken am Netzteil und den CPU-Komponenten muß die Rückseite des Gerätes mindestens 50cm von anderen Geräten und der Wand entfernt sein.

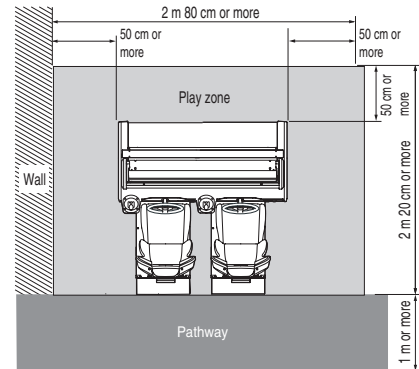

Zum leichteren Transport ist das Gerät mit Rollen ausgerüstet. Daher besondere Vorsicht auf abschüssigem Boden



Der Schwerpunkt des Aufsatzes liegt sehr weit vorn. Daher werden für den Ab- und Aufbau des Aufsatzes mindestens 2 Personen benötigt.



Der Aufsatz wird in großer Höhe montiert. Daher muß aus Sicherheitsgründen eine Steighilfe, wie z. B. eine Leiter, ein Tritt oder ähnliches, verwendet werden.



Die Gesamthöhe des Gerätes beträgt 2.05m. Daher Vorsicht bei tiefer hängenden Beleuchtungskörpern.

AUS- UND EINBAU VON KOMPONENTEN UND TEILEN



Aufstellung, Service, Einstellung und Wartung dürfen nur von dafür qualifiziertem Fachpersonal durchgeführt werden.



Es dürfen keinerlei Veränderungen ohne vorherige Genehmigung am Gerät vorgenommen werden. Zuwiderhandlungen stellen eine Gefahrenquelle dar.



Für die Reparatur dürfen nur Originalersatzteile (incl. Schrauben) von NAMCO EUROPE LTD. verwendet werden.



Vor Beginn aller Wartungsarbeiten (Fehlersuche, Reparaturen etc.) muß der Netzstecker gezogen werden.



Bei Arbeiten, die nicht in diesem Handbuch beschrieben werden, muß vorher der Händler zu Rate gezogen werden, da sonst keinerlei Haftung bei Beschädigungen und Verletzungen übernommen wird.



Teile des Netzteiles und Bildschirms bleiben nach Abschalten noch heiß und führen Hochspannung. Dies kann zu Verbrennungen oder einem Elektroschlag führen. Diese Teile dürfen nicht berührt werden.



Vor der Montage oder dem Entfernen von Steckverbindungen und Steckern muß das Gerät ausgeschaltet werden.



Bei Ziehen des Gerätesteckers oder des Netzsteckers aus der Wandsteckdose stets den Stecker greifen und nicht das Kabel.



Denne udgivelse må ikke reproducere af nogen som helst mekanisk, fotografisk eller elektrisk proces eller i form af indspilning, den må heller ikke lagres i et eftersøgningsystem transmitteres eller kopieres til nogen form for offentlig benyttelse uden tilladelse fra **Namco Europe Limited**.

Da informationerne i denne manual er givet med god tro og var korrekt på udgivningstidspunktet, forbeholder Namco Europe Limited sig retten til, at foretage ændringer og forandringer uden varsel.

Denne maskine er fremstillet i overensstemmelse med Det Europæiske fællesskabs direktiver og er blevet testet og fuldendt med direktiverne 89/336/EEC og 72/23/EEC standarder (se manualens forside) og som sådan bærer CE mærket. Enhver form for ændring eller modifikation af denne maskine skal være i overensstemmelse med Det Europæiske fællesskabs direktiver.

I tilfælde af forbigående ekstreme eksterne forstyrrelser, så som radio udsendelser, elektronisk afgivelse eller forstyrrelser på ledningsnettet, kan nedbrydning forekomme. Maskinen vil dog køre normalt så snart forstyrrelsen ophører eller bliver fjernet.

Bemærk:- Hvis spilleprocessoren resetter p.g.a. en forstyrrelse eller reduktion af hovedstrømmen kan de etablerede kreditter gå tabt.

Dette spil er ikke en maskine defineret af maskin direktivet 89/392/EEC -

SIKKERHEDS ADVARSEL

For at betjene denne maskine sikkert, læs da denne brugemanual grundigt før installation, justering eller brug af maskinen. Når som helst ejeren af denne maskine overlader demontering, installation, justeringer eller daglig vedligehold til en anden person, skal ejeren sikre sig at denne person læser de sikkerhedsregler og relevante punkter i denne manual før arbejdet begynder.

For at undgå ulykker når maskinen er i gang, følg nøje de sikkerhedsregler der er beskrevet herunder. Denne manual sammen med installations manualen er en uøselig del af udstyret og skal altid være til rådighed for det arbejdende og servicepersonale.

Denne maskine er kun til indendørs brug og bør kun bruges til det beregnede formål.

Namco Ltd. bærer intet ansvar for ulykker eller skader som er et resultat af uautoriserede ændringer eller fejlagtig brug af denne maskine.











SIKKERHEDSREGLER

De følgende sikkerhedsregler er brugt helt igennem denne manual. Gør dig bekendt med hver enkelt af dem og meningen heraf før installation, servicering eller justering af denne maskine.

ADVARSEL  **Advarsel betegner en episode der kan resultere i skader eller død. Begiv dig ikke forbi et advarselsskilt før de indikerede betingelser er fuldstændig forstået.**

FORSIGTIG  **Forsigtig betegner en episode der kan resultere i ødelæggelse af maskinen. Begiv dig ikke forbi et advarselsskilt før de indikerede betingelser er fuldstændig forstået.**

GENERELLE SIKKERHEDSOVERVEJELSER

-  **Betjen kun maskinen efter at have tjekket, at den er korrekt installeret og er i overensstemmelse med manualen.**
-  **Dele af denne maskine er i bevægelse når den kører så der er steder hvor afstanden mellem den stationære og den bevægende sektion ændrer sig. Der er advarselsskilt om, at holde hænder og fødder væk fra de bevægelige dele, dog skal lederen straks advare en person han føler der er i fare.**
-  **Advarselsskiltene skal altid være i god stand og erstattes hvis de er slidt, så kunden tydeligt kan læse dem.**
-  **Installations service, justeringer eller daglig vedligehold bør kun udføres af en kvalificeret person.**
-  **For fortsat beskyttelse mod brandfare, sikres at hoved sikringerne kun erstattes med samme type kapacitet. Brug af anden kapacitet eller materiale er forbudt.**
-  **Strømforsyningen inde i monitoren vil forblive varm og have områder med høj spænding selvom maskinen har været slukket og der er fare for brandskader eller elektrisk stød. Pas på med at røre disse områder.**
-  **For at undgå elektrisk stød p.g.a. en fejl skal denne maskine være forbundet med et sikkert jordstik.**
-  **Hvis hoved ledningerne på noget tidspunkt bliver beskadiget skal de strakt erstattes.**
-  **Tænd ikke for strømmen før maskinen er korrekt installeret.**
-  **Før tilslutning af maskinen til hovedstrømmen sikres, at maskinen er indstillet til den rette spænding.**

PUNKTER OM INSTALLATION

 **Tænd aldrig for strømmen til maskinen før installation er fuldført.**

 For at undgå mulige elektriske stød sikres, at maskinen er forbundet til hovedstrømmen med sikkert monterede jordstik.

 For at kunder ikke kommer til skade ved spillets bevægelser sikres, at der er mindst 50cm afstand til andre maskiner og vægge.

 For at undgå skader på maskinen p.g.a. fejlbetjening sikres, at spændingen på hovedstrømmen er 230 volt AC.

BEMÆRK : Hvis denne maskine placeres på et poleret gulv, anbefales det at ligge gummimåtter under justeringsfødderne for at undgå at maskinen glider på gulvet.

BEMÆRK : For at få adgang til strømforsyningen og CPU justeringer sikres, at bagsiden af hoved kabinettet står adskilt fra andre maskiner eller væggen med mindst 50cm.

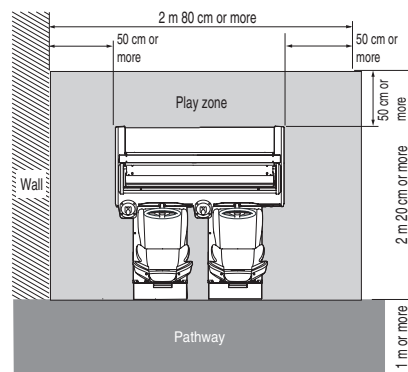

 **Maskinen er smurt med olie for at gøre den lettere bevægelig. Pas på når maskinen flyttes på en skrå overflade.**

 **Hoved sektionens forreste center er meget tung, det er derfor vigtigt, at mindst 2 personer benyttes til at montere el. flytte hoved sektionen.**

 **Monterins højden af hoved sektionen er meget høj og det er vigtigt, at have hjælpemidler til at nå sikkert uden at skulle strække sig. (fek.s. trapper, trappestole el. lign.).**

 **Den fulde højde af hoved sektionen er 2.05m. Pas på øvre forhindringer f.eks. lys inventar**

AT FJERNE OG UDSKIFTE SEKTIONER OG DELE.

 **Justeringer eller vedligehold af denne maskine bør kun udføres af kvalificeret personale.**

 **Skift ikke noget på maskinen uden godkendelse, det kan føre til uforudset fare.**

 **Der bør kun bruges dele specificeret af Namco Europe Limited når der skiftes eller repareres dele (inklusiv skruer).**

 **Sørg for, at strømmen til maskinen er slukket før der foretages nogen form for arbejde (fejlfinding, reparation etc.)**

 **Hvis der foretages arbejde der ikke er beskrevet i denne manual, kontakt da din leverandør for at få kyndig vejledning, da intet ansvar vil blive accepteret ved skader.**

 **Dele af strømforsyningen og monitoren forbliver varme eller bærer høj spænding selv efter maskinen er slukket, det kan føre til forbrændinger eller elektriske stød. Pas på ikke at røre disse dele ved et uheld.**

 **Læg mærke til at maskinen er slukket før samlinger eller stik tages ud eller sættes i.**

 **Når hovedsamlingen fjernes fra maskinen eller hovedstikket fjernes fra væggen, tag da altid ved stikket, ikke ledningen.**



No se permite la reproducción total ni parcial de esta publicación por ningún medio mecánico, fotográfico o electrónico, grabaciones fonográficas, ni su almacenamiento informático, su transmisión o su copia, ya sea para uso público o privado, sin permiso de NAMCO EUROPE LIMITED.

Si bien la información contenida en este manual se da de buena fe y es correcta en el momento de su impresión, NAMCO EUROPE LIMITED se reserva el derecho de hacer cambios y alteraciones sin previo aviso.

Esta máquina ha sido fabricada según las directrices de la Comunidad Europea, ha sido probada, y se ajusta a las directrices 89/336/EEC y 72/23/EEC, mediante la aplicación de los estándares EN55014-1, EN55014-2 y EN60335-2-82 (véase cubierta del manual) y por ende lleva el sello de la C.E. Cualquier cambio o modificación que se haga a esta máquina ha de ajustarse a las directrices de la Comunidad Europea. Cualquier cambio no autorizado hecho al producto pudiera contravenir estas directrices.

Bajo ciertas condiciones de extrema interferencia externa, p. ej. transmisiones de radio, descargas electrostáticas u oscilaciones de la red eléctrica puede tener lugar un descenso del rendimiento. No obstante, la máquina recuperará su rendimiento normal una vez que la fuente de interferencias sea retirada o cese de producirlas.

Nota: Si el procesador de juegos se reinicializa a causa de caídas o interrupciones en la alimentación eléctrica, se perderán todos los créditos.

Este juego no se ajusta a la definición de máquina de la Normativa de Maquinaria 89/392/EEC

AVISOS DE SEGURIDAD.

Para utilizar esta máquina con seguridad, lea cuidadosamente este Manual de Operador antes de proceder a la instalación, ajuste o uso de esta máquina.

Cada vez que el propietario de esta máquina confíe a terceros su desmontaje, instalación, ajuste o mantenimiento rutinario deberá asegurarse de que tales personas lean las precauciones adecuadas y las secciones relevantes de este manual antes de comenzar su trabajo.

Para que no ocurra accidente alguno mientras la máquina se encuentre en funcionamiento, siga estrictamente las notas de seguridad tal como más adelante se describen.



Este manual, junto con el Manual de Instalación (cuando proceda), forma parte integral del equipo y debe estar a disposición del personal de mantenimiento y operación en todo momento.

Esta máquina es únicamente para ser usada en interiores, y sólo debe usarse para aquello para lo que ha sido creada.











Namco Ltd. queda exenta de cualquier responsabilidad por accidentes, heridas o daños causados por cambios no autorizados o uso indebido de esta máquina.

NOTAS DE SEGURIDAD.

En este manual se usan las notas siguientes. Familiarícese con cada una de ellas y su significado antes de instalar, revisar, o hacer ajustes en esta máquina.

- AVISO.**  **Aviso señala un riesgo que puede ocasionar lesiones o la muerte. Tras ver esta nota, no continúe hasta entender completamente y cumplir las condiciones exigidas.**
- PRECAUCIÓN.**  **Precaución señala un riesgo que puede ocasionar daños a la máquina. Tras ver esta nota, no continúe hasta entender completamente y cumplir las condiciones exigidas.**

CONSIDERACIONES GENERALES DE SEGURIDAD.

-  **Opere sólo con esta máquina tras comprobar que ha sido instalada correctamente y de acuerdo con este manual.**
-  **Algunas partes de esta máquina se mueven durante el juego; por tanto, hay lugares en que la distancia entre las secciones móviles y estáticas cambia. Existen notas de aviso indicando que se mantengan manos y pies alejados de las partes móviles. No obstante, si el operador cree que cualquier persona se encuentra en peligro, debe advertir de ello a dicha persona.**
-  **Las notas de aviso deben mantenerse siempre en buen estado y reemplazarse si estuvieran desgastadas para que los usuarios puedan leerlas con claridad.**
-  **Las revisiones de instalación, los ajustes, y el mantenimiento rutinario deberán llevarse a cabo sólo por personal cualificado.**
-  **Para asegurar una continua protección contra riesgo de incendios, asegúrese de que los fusibles eléctricos sean reemplazados solamente por otros del mismo tipo y especificaciones. El uso de otros fusibles o material está prohibido.**
-  **La fuente de alimentación del monitor se mantiene caliente, y tiene zonas de alto voltaje incluso cuando la máquina ha sido desconectada, existiendo el riesgo de quemaduras y descargas eléctricas. Tenga cuidado de no tocar estas zonas.**
-  **Para evitar posibles descargas eléctricas por cortes, esta máquina debe estar provista de un enchufe debidamente conectado, con TOMA DE TIERRA.**
-  **Si en cualquier momento el cable de alimentación se dañara, deberá ser reemplazado inmediatamente.**
-  **No encienda el interruptor de la máquina hasta que ésta haya sido correctamente instalada.**
-  **Antes de enchufar la máquina a la red eléctrica, asegúrese de que la máquina está preparada para el voltaje correcto, y de que se usan los fusibles adecuados.**

NOTAS DE INSTALACIÓN.



JAMÁS ENCIENDA la máquina antes de haber completado la instalación.



Para evitar posibles descargas eléctricas, asegúrese de que la máquina está conectada a la red con un enchufe provisto de toma de tierra.



Para que los usuarios no sufran lesiones debido al movimiento del juego, asegúrese de que hay al menos 500 mm de separación entre éste y otras máquinas o las paredes.



Para evitar daños a la máquina causados por operación incorrecta, asegúrese de que el voltaje de la red es de 230 voltios, corriente alterna.

Notas : Si el lugar donde se instalará la máquina tiene un piso pulido, se recomienda colocar tacos de goma bajo los ajustadores de nivel para evitar que la máquina se deslice por el suelo.

Notas : Para acceder a las unidades de Fuente de Alimentación y CPU, asegúrese de que la parte trasera del mueble principal está separada de muros u otras máquinas al menos 500 mm.

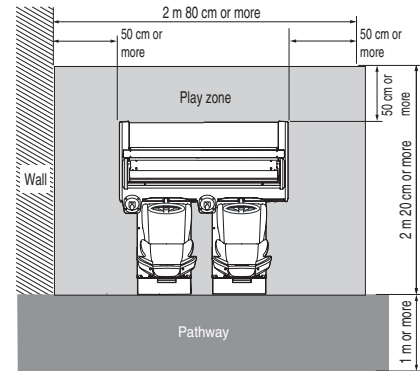

El juego tiene ruedecitas para hacer más fácil su traslado. Tenga cuidado al mover la máquina en una superficie inclinada.



La Unidad de Igualación tiene el centro de gravedad desplazado hacia adelante. Es importante que su montaje y desmontaje se haga por al menos dos personas.



La posición de la Unidad de Igualación es bastante alta, y es importante que haya un medio de alcanzar su altura con seguridad, sin estirarse (p. ej. una escalera, un taburete, etc.)



La altura total de la Unidad principal es de 2.05m. Tenga cuidado de que no haya obstáculos p. ej. luces.

RETIRAR Y REEMPLAZAR PARTES Y UNIDADES.



Las revisiones de instalación, los ajustes, y el mantenimiento rutinario deberán llevarse a cabo sólo por personal cualificado.



No realice alteraciones en esta máquina sin aprobación previa. De hacerlo así, pueden causar peligros imprevisibles.



Sólo deben usarse las partes especificadas por Namco Europe Ltd. para reparaciones o reemplazos (incluidos los tornillos).



Asegúrese de que la máquina está desconectada antes de comenzar cualquier trabajo de mantenimiento (reparaciones, resolución de problemas, etc.)



Al realizar trabajos no descritos en este manual, póngase en contacto con su distribuidor para recibir instrucciones. Se declina cualquier responsabilidad por daños o lesiones.



Hay partes de la fuente de alimentación y del monitor que se mantienen calientes o almacenan alto voltaje incluso tras desconectar la máquina, y pueden producir quemaduras o descargas eléctricas. Tenga cuidado de no tocar accidentalmente estas partes.



Asegúrese de que la máquina está apagada antes de conectar o desconectar cualquier enchufe o conector.



Al retirar el conector principal de la máquina, o la clavija de alimentación del enchufe de la red, agarre siempre la clavija y no el cable.



Aucun élément de cette publication ne sera reproduit, ni par procédé mécanique, photographique ou électronique, ni par un moyen d'enregistrement phonographique. Ces informations ne seront ni stockées grâce à un procédé de récupération, ni transmises ou autrement copiées pour un usage public ou privé, sans l'autorisation de **NAMCO EUROPE LIMITED**.

Malgré le fait que les informations contenues dans ce manuel soient données de bonne foi et étaient actualisées au moment de leur impression, NAMCO EUROPE LIMITED se réserve le droit de procéder à des changements ou à des modifications sans avis préliminaire.

Ce jeu a été fabriqué en respect des normes de la Communauté Européenne, après avoir été testé il répond aux normes 89/336/EEC et 72/23/EEC, en application des standards EN55014-1, EN55014-2 et EN60335-2-82 (voir la couverture du manuel), et comme tel il comporte l'autocollant de conformité avec les normes de la Communauté Européenne. Tout changement non autorisé sur ce produit pourrait contrevenir à ces normes.

Sous certaines conditions extrêmes d'interférence externe, par exemple des transmissions radio, des décharges électrostatiques ou bien de interférences passagères sur le réseau, certaines dégradations ou anomalies peuvent se produire. Le jeu retrouvera cependant son état normal de fonctionnement lorsque la cause de ces anomalies aura cessé ou se trouvera déplacée.

Note:-

Si le processeur du jeu se reprogramme suite à une interruption ou une réduction de l'alimentation, les crédits qu'il aurait pu contenir peuvent se trouver perdus.

Ce jeu n'est pas une machine, telle que définie par la norme sur les machines 89/392/EEC

MESURES DE SECURITE

Afin d'utiliser ce jeu en toute sécurité, bien lire ce manuel d'utilisation avant de procéder à son installation, son réglage ou son exploitation.

Si le propriétaire de ce jeu en confie la démontage, l'installation, le réglage ou la maintenance habituelle à une autre personne, il devra s'assurer que cette personne ait lu les conseils d'utilisation et les passages du manuel se rapportant à ce thème, avant qu'elle ne commence son travail.

Afin d'éviter tout accident pendant la durée d'exploitation de ce jeu, se conformer strictment aux conseils de sécurité décrits à la suite.

Ce manuel ainsi que le manuel d'installation du jeu (là où nécessaire) font partie des éléments nécessaires à l'installation de la machine et doivent être mis à la disposition de l'utilisateur et du personnel de maintenance à tout moment.

Ce jeu est uniquement destiné à un usage intérieur et devra être utilisé comme tel.

Namco Ltd. ne sera aucunement tenu responsable en cas d'accidents, de blessure ou de dommage quelconque résultant de modifications non autorisées ou d'usage impropre du jeu.











REMARQUES SUR LA SECURITE

Les termes de sécurité détaillés à la suite seront utilisés tout au long de la lecture de ce manuel. Il convient de vous familiariser avec chacun de ces termes ainsi que leur signification avant de procéder à l'installation, à la maintenance ou au réglage du jeu.

AVERTISSEMENT  Ce terme annonce un danger qui pourrait éventuellement avoir des conséquences dommageables ou mortelles. Ne pas passer outre ce signal jusqu'à ce que les conditions indiquées soient entièrement comprises et effectuées.

ATTENTION  Ce terme indique qu'un danger menace la machine. Ne pas passer outre ce signal jusqu'à ce que les conditions indiquées soient entièrement comprises et effectuées.

CONSIGNES GENERALES DE SECURITE

-  **Allumer l'appareil seulement après avoir vérifié qu'il a été correctement installé, et que les instructions du manuel ont été respectées.**
-  **Certaines pièces du jeu bougent quand jeu est en fonctionnement, il y a donc des endroits où la distance entre la zone stationnaire et la zone en mouvement change. Il existe des notes de mise en garde pour les mains et pieds sur les pièces en mouvement. Cependant si l'opérateur pense qu'une personne court un danger, il doit l'en avertir.**
-  **Les notes de mise en garde doivent constamment demeurer en bon état et être remplacées en cas de disparition, afin que le client puisse les lire clairement.**
-  **L'installation, le service, le réglage, ou la maintenance doivent être effectués uniquement par les personnes qualifiées.**
-  **Afin d'éviter un éventuel incendie, s'assurer que les fusibles soient remplacés par le même type de fusibles et au bon voltage. L'utilisation d'autres sortes de fusibles ou autres matériels est interdite.**
-  **L'alimentation à l'intérieur du moniteur reste chaude et comporte des zones de haute tension même si la machine est éteinte. Il existe donc un risque de brûlure ou d'électrocution. Attention à ne pas toucher ces endroits.**
-  **Pour prévenir une éventuelle électrocution due à un défaut matériel, ce jeu DOIT être muni d'une prise de TERRE connectée en toute sécurité**
-  **Si à tout moment les fils électriques sont endommagés, il faut les remplacer immédiatement**
-  **Ne pas mettre le jeu en mode de fonctionnement avant qu'il n'ait été correctement installé.**
-  **Avant de connecter la machine au réseau, s'assurer que la machine est installée sous la bonne tension et que les fusibles correspondent.**

NOTES D'INSTALLATION



NE JAMAIS mettre le jeu en marche avant que l'installation ne soit complètement effectuée.



Afin de prévenir une éventuelle électrocution, s'assurer que la machine est connectée au réseau avec une prise de terre reliée selon les normes de sécurité.



Afin que les clients ne soient pas blessés par les mouvements du jeu, s'assurer qu'il existe au moins 500 mm de séparation avec les autres jeux ou les murs.



Afin d'éviter que la machine ne soit abîmée suite à une mauvaise opération, s'assurer que la tension sur le réseau principal soit de 230 volts AC.

Note: Si l'endroit où doit être installée la machine à un sol poli, il est recommandé de poser des tampons feutrés sous les vérins pour éviter que le jeu ne glisse sur le sol.

Note: Afin de faciliter l'accès aux CPU et à l'alimentation, s'assurer qu'il y a un espace d'au moins 500 mm entre l'arrière du meuble et le mur ou tout autre jeu.

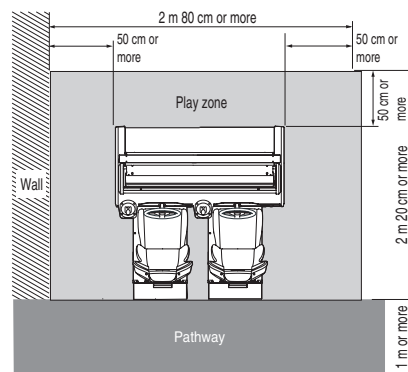

Le jeu est fourni avec des roulettes pour une meilleure mobilité. Prendre garde quand la machine est déplacée sur une surface inclinée.



Le centre de gravité de la partie supérieure du jeu est situé sur l'avant, il est donc indispensable que deux personnes au moins soient employées pour installer ou déplacer la partie supérieure.



L'installation de la partie supérieure du jeu s'effectue en hauteur, il est donc important d'utiliser un élévateur quelconque pour en effectuer le montage.



La hauteur totale de l'assemblage principal est de 2050 mm, prendre garde aux encombrements de la partie supérieure (ex : illuminations du bandeau).

DEPLACER ET REMPLACER LES UNITES ET LES PIECES DETACHEES.



L'installation, le service, le réglage, ou la maintenance doivent être effectués uniquement par les personnes qualifiées.



Ne pas apporter de modifications sur cette machine sans autorisation préalable, faute de quoi cela pourrait entraîner un danger.



Seules les pièces détachées Namco Europe Ltd. doivent être utilisées pour le remplacement ou la réparation de pièces (y compris les vis)



S'assurer que l'interrupteur soit sur OFF avant de commencer tout travail de maintenance (localisation d'une panne, réparations, etc.)



Si dans ce manuel il manque une information pour réaliser un quelconque travail, contacter votre distributeur, car aucune responsabilité ne sera acceptée en cas de dommage ou de blessure.



Les pièces de l'alimentation et du moniteur restent chaudes, à tension élevée même lorsque la machine est hors tension, elle pourrait occasionner des brûlures ou des électrocutions. Attention de ne pas toucher ces endroits accidentellement.



S'assurer que la machine soit hors tension avant de brancher ou débrancher toute prise ou connecteur.



Lorsque l'on manipule la prise au réseau de la machine, ou lorsque les prises principales doivent être débranchées, saisir toujours la prise, et non le câble.



Κανένα μέρος αυτής της έκδοσης δεν μπορεί να αναπαραχθεί με οποιοδήποτε μηχανικό, φωτογραφικό ή ηλεκτρονικό μέσο, ή με μορφή φωνητικής ηχογράφησης και ούτε να αποθηκευτεί με επανωρθωτικό σύστημα, να μεταδοθεί ή να αντιγραφεί για δημόσια ή ιδιωτική χρήση, χωρίς την άδεια της NAMCO EUROPE LIMITED.

Καθώς αυτές οι πληροφορίες σε αυτό το εγχειρίδιο έχουν δοθεί με καλή πίστη και ακριβώς την ώρα της τύπωσης, η εταιρεία NAMCO EUROPE LIMITED κρατάει το δικαίωμα να κάνει οποιοδήποτε αλλαγές χωρίς ειδοποίηση.

Τα μηχανήματα έχουν κατασκευαστεί σύμφωνα με τους όρους της Ευρωπαϊκής Κοινότητας, και έχουν ελεγχθεί σύμφωνα με τους νόμους 89/336/EOK και 72/23/EOK με την αίτηση των EN55014-1, EN55014-2 και EN60335-2-82 στάνταρτς (δες μπροστά στο εγχειρίδιο) και όλα έχουν το CE σήμα. Οποιαδήποτε αλλαγή ή μετατροπή σε αυτό το μηχάνημα πρέπει να είναι σύμφωνα με τους όρους της Ευρωπαϊκής Κοινότητας. Οποιοσδήποτε αλλαγές χωρίς άδεια σε αυτό το προϊόν μπορεί να παραβεί αυτούς τους όρους.

Σε κάποιες περιπτώσεις υπερβολικής εξωτερικής παρεμβολής, π.χ. ραδιοφωνικές μεταδόσεις, ηλεκτροστατικές μεταβολές ή παροδικές εμβολές, μπορεί να παρουσιαστούν κάποιες αθλιότητες στην παρουσίαση. Πάντως το μηχάνημα θα επανέλθει στην φυσιολογική παρουσίαση εφ' όσον η πηγή της παρεμβολής σταματήσει ή απομακρυνθεί.

Σημείωση: Εάν γίνει reset στον processor του μηχανήματος κατά τη διάρκεια της κύριας παροχής, πόντοι που έχουν κερδηθεί μπορεί να χαθούν.

Αυτό το παιχνίδι δεν είναι μηχάνημα όπως προσδιορίζεται από τους όρους Μηχανημάτων 89/392/EOK.

ΟΔΗΓΙΕΣ ΑΣΦΑΛΕΙΑΣ

Για την ασφαλή χρήση του μηχανήματος, πρέπει να διαβάσεις το εγχειρίδιο χρήσης προσεκτικά πριν την εγκατάσταση, τοποθέτηση ή χρήση του μηχανήματος.

Οποτεδήποτε ο ιδιοκτήτης αυτού του μηχανήματος ζητάει από κάποιο πρόσωπο να εγκαταστήσει, να κάνει οποιαδήποτε αλλαγή ή έλεγχο ρουτίνας στο μηχάνημα, πρέπει να είναι σίγουρος ότι έχει διαβάσει τις οδηγίες αυτού του εγχειριδίου πριν να αρχίσει να δουλεύει.

Προς αποφυγήν οποιοσδήποτε ατυχήματος κατά την λειτουργία του μηχανήματος, αυστηρώς ακολουθούνται οι οδηγίες ασφάλειας όπως δίνονται παρακάτω.

Αυτό το εγχειρίδιο σε συνδυασμό με το εγχειρίδιο εγκατάστασης (όπου διατίθεται) αποτελεί ένα ολοκληρωμένο μέρος των παροχών και πρέπει να είναι διαθέσιμο για την λειτουργία και το service οποιαδήποτε στιγμή.

Αυτό το μηχάνημα είναι για χρήση μόνο σε εσωτερικό χώρο και θα πρέπει να χρησιμοποιείται μόνο για τους λόγους για τους οποίους κατασκευάστηκε.

Η εταιρεία NAMCO Ltd δεν φέρει καμία ευθύνη για ατυχήματα, πληγές ή καταστροφές που μπορεί να προκληθούν από αλλαγές χωρίς άδεια σε ή εισαγωγείς αυτού του μηχανήματος.

ΣΗΜΕΙΩΣΕΙΣ ΑΣΦΑΛΕΙΑΣ

Οι ακόλουθες σημειώσεις ασφάλειας χρησιμοποιούνται μέσω αυτού του εγχειριδίου. Διάβασε αυτές προσεκτικά για να γίνει κατανοητό το νόημά τους πριν την εγκατάσταση, σέρβις ή οποιαδήποτε αλλαγή γίνει στο μηχάνημα.

ΠΡΟΕΙΔΟΠΟΙΗΣΗ



Η προειδοποίηση αφορά κίνδυνο ο οποίος μπορεί να είναι λόγος θανάτου. Να μην προχωρήσεις σε οποιαδήποτε κίνηση μέχρι αυτοί οι όροι γίνουν κατανοητοί.

ΠΡΟΣΟΧΗ



Η προσοχή αφορά κίνδυνο ο οποίος μπορεί να προκαλέσει πρόβλημα στο μηχάνημα. Να μην προχωρήσεις σε οποιαδήποτε κίνηση μέχρι αυτοί οι όροι γίνουν κατανοητοί.

ΕΞΕΤΑΣΗ ΓΕΝΙΚΗΣ ΑΣΦΑΛΕΙΑΣ

Αφού έχει κατανοηθεί αυτό το εγχειρίδιο, μόνο τότε να λειτουργήσει το μηχάνημα ή να γίνει έλεγχος εφ' όσον έχει γίνει η εγκατάσταση.

Μέρη του μηχανήματος μετακινούνται κατά την διάρκεια ενός παιχνιδιού, έτσι ώστε να υπάρχουν μέρη όπου η απόσταση μεταξύ του μέρους στάθμευσης και τόπου κίνησης να μπορεί να αλλάξει. Υπάρχουν προειδοποιήσεις να είναι τα χέρια και τα πόδια μακριά από τα μέρη που κινούνται, όμως ο ιδιοκτήτης πρέπει να ελέγχει εάν κάποιος κινδυνεύει να τον ειδοποιήσει και να τον απομακρύνει.

Οι προειδοποιήσεις πρέπει να μένουν καθαρές και σε καλή κατάσταση ώστε ο πελάτης να τις διαβάζει καθαρά.

Εγκατάσταση, μετατροπή ή έλεγχος ρουτίνας μπορεί να γίνεται μόνο από εξουσιοδοτημένα άτομα.

Για συνεχή προστασία από φωτιά, πρέπει οι ασφάλειες να αντικαθιστούνται με ίδιου τύπου. Η χρήση άλλων ασφαλειών ή αντικειμένων απαγορεύεται.

Το τροφοδοτικό στο εσωτερικό του μηχανήματος θα παραμείνει ζεστό και υπάρχουν περιοχές με υψηλή τάση παρ'όλο που το μηχάνημα δεν δουλεύει, και υπάρχει η πιθανότητα ηλεκτρικού σοκ. Προσοχή να μην ακουμπήσεις αυτές τις περιοχές.





Για την αποφυγή ηλεκτρικών σοκ λόγω βλάβης, το μηχάνημα ΠΡΕΠΕΙ να έχει πρώτα ενωθεί με γείωση.

Εάν κάποια στιγμή καταστραφεί η κύρια παροχή, πρέπει να αντικατασταθεί αμέσως.

Να μην ανάψει το μηχάνημα (switch ON) μέχρι να έχει εγκατασταθεί σωστά και πλήρως.

Πριν την παροχή ρεύματος στο μηχάνημα, να είσαι σίγουρος ότι τα voltage και όλες οι ασφάλειες είναι σωστά ενωμένα και τοποθετημένα.





ΣΗΜΕΙΩΣΕΙΣ ΓΙΑ ΤΗΝ ΕΓΚΑΤΑΣΤΑΣΗ

-  ΠΟΤΕ να μην ανάβει το μηχάνημα εάν δεν έχει ολοκληρωθεί η εγκατάσταση.
-  Για την αποφυγή ηλεκτρικών σοκ πρέπει το μηχάνημα να έχει γειωθεί.
-  Για την αποφυγή κινδύνου σε κάποιον παίκτη , πρέπει το μηχάνημα να έχει απόσταση τουλάχιστον 500mm από άλλο μηχάνημα ή τοίχο.
-  Για την αποφυγή βλάβης στο μηχάνημα λόγω λάθος λειτουργίας , πρέπει η παροχή να είναι 230volt AC..

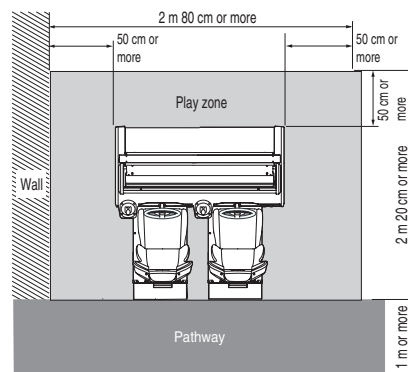







ΣΗΜΕΙΩΣΗ: Εάν το πάτωμα στο οποίο είναι τοποθετημένο το μηχάνημα γλιστράει, είναι καλό να μπει ένα κομμάτι μοκέτας για αποφυγή μετακίνησης του μηχανήματος εν ώρα λειτουργίας του.

ΣΗΜΕΙΩΣΗ: Για την εύκολη πρόσβαση στην κυρίως παροχή ή το CPU πρέπει η πίσω πόρτα του μηχανήματος να απέχει τουλάχιστον 500mm από τον τοίχο ή άλλο μηχάνημα.



-  Το μηχάνημα είναι εφοδιασμένο με καρούλια για την εύκολη μετακίνησή του.
-  Το επάνω μέρος του μηχανήματος έχει επιπλέον βάρος γιατί χρειάζονται δύο για την μεταφορά.
-  Η κεφαλή (καπάκι) του μηχανήματος είναι πολύ ψηλό και γιαυτό χρειάζεται προσοχή στην τοποθέτησή του , να μην χτυπήσει ή καταστραφεί.
-  Το συνολικό ύψος της κεφαλής είναι 2050mm . Φρόντισε να μην χτυπήσει σε λάμπες κ.λ.π.

ΑΠΟΜΑΚΡΥΝΣΗ ΚΑΙ ΑΝΤΙΚΑΤΑΣΤΑΣΗ ΜΕΡΩΝ - ΑΝΤΑΛΛΑΚΤΙΚΩΝ

-  Εγκατάσταση , μετατροπή ή έλεγχος ρουτίνας μπορεί να γίνεται μόνο από εξουσιοδοτημένα άτομα .
-  Δεν πρέπει να γίνονται μετατροπές στα μηχανήματα χωρίς έγκριση . Μπορεί να προκληθεί απρόβλεπτος κίνδυνος.
-  Μόνο μέρη που διευκρινίζονται από την εταιρεία NAMCO EUROPE Ltd μπορούν να χρησιμοποιηθούν για αντικατάσταση ή επιδιόρθωση. (συμπεριλαμβάνονται και οι βίδες)
-  Να είναι σίγουρα κλειστό το ρεύμα πριν οποιαδήποτε δουλειά στο μηχάνημα.
-  Εάν γίνει κάποια δουλειά στο μηχάνημα χωρίς να διευκρινίζεται στο εγχειρίδιο , να επικοινωνήσεις με τον αντιπρόσωπο για οδηγίες γιατί καμία ευθύνη δεν φέρουμε για καταστροφές ή βλάβες.
-  Μέρη του τροφοδοτικού ή του μόνιτορ παραμένουν ζεστά ή έχουν υψηλή τάση ακόμα και όταν σβήσει το μηχάνημα και μπορούν να προκαλέσουν κάψιμο ή λεκτροσόκ. Γιαυτό δεν πρέπει να έρχονται σε επαφή με χέρια .
-  Το μηχάνημα πρέπει να είναι σβηστό κατά την σύνδεση ή αποσύνδεση πρίζας ή κονέκτορα.
-  Κατά την απομάκρυνση των κεντρικών κονέκτορ από το μηχάνημα ή της κυρίας πρίζας , πρέπει να πιάνουμε το πλαστικό μέρος και όχι το καλώδιο.



Nessuna parte di questa pubblicazione può essere riprodotta con processo meccanico, fotografico o elettronico, nè sotto forma di registrazione fonografica, nè può essere memorizzata in un sistema di salvataggio, trasmessa o in altro modo copiata per uso pubblico o privato, senza l'autorizzazione di **NAMCO EUROPE LIMITED**.

Le informazioni contenute in questo manuale sono state date in buona fede ed erano accurate al momento della pubblicazione. Tuttavia NAMCO EUROPE LIMITED, si riserva il diritto di apporre cambiamenti e variazioni senza alcun preavviso.

Questo apparecchio è stato costruito in conformità alle Direttive della Comunità Europea, ed è stato provato e soddisfa le Direttive 89/336/EEC e 72/23/EEC per l'applicazione degli standards delle norme EN55014-1, EN55014-2 e EN60335-2-82 (vedi fronte del manuale), e per questo porta il marchio CE. Qualsiasi cambiamento o modifica di questo apparecchio deve essere in conformità con le Direttive della Comunità Europea.

In caso di condizioni di estrema interferenza dall'esterno, per esempio trasmissioni radio, scariche elettrostatiche o transistori sulla linea, può verificarsi un decadimento delle prestazioni. Comunque l'apparecchio ritornerà al rendimento normale quando la sorgente dell'interferenza avrà cessato di emettere o sarà stata rimossa.

Nota bene: se il processore del gioco "resetta" a causa di una interruzione o diminuzione del voltaggio di linea, un eventuale credito, già concesso, può essere annullato.

Questo gioco non è una macchina così come viene definita dalla Direttiva Macchine 89/392/EEC.

AVVERTENZE PER LA SICUREZZA

Allo scopo di usare questo apparecchio in sicurezza, leggere questo Manuale dell'operatore attentamente prima dell'installazione, regolazione o uso di questa macchina.

Tutte le volte che il proprietario di questo apparecchio affida lo smontaggio, l'installazione, la regolazione o la manutenzione ordinaria ad un'altra persona, il proprietario stesso deve assicurarsi che quella persona legga le precauzioni necessarie e i paragrafi importanti di questo manuale prima di iniziare a lavorare.

Perchè non succeda alcun incidente quando la macchina è operante, seguire rigorosamente le note sulla sicurezza come specificato più avanti.

Questo manuale insieme con il manuale di installazione (dove si può applicare) forma una parte integrante dell'apparecchio e deve essere disponibile sempre al personale operante e di servizio.

Questa macchina deve essere usata solo in interni e deve essere usata solo per gli scopi per cui è progettata.

Namco Europe Ltd non si assume responsabilità per incidenti, ferite o danni risultanti da cambiamenti non autorizzati o da uso improprio della macchina.

NOTE PER LA SICUREZZA

Le seguenti note sulla sicurezza sono usate dal principio alla fine di questo manuale. Valutare attentamente ciascuna di queste note ed il loro significato prima di installare, fare assistenza o regolazioni su questa macchina.

WARNING  "Warning" evidenzia un rischio di ferita o di morte. Non procedere oltre una nota "Warning" finchè le avvertenze specificate non siano completamente capite e conosciute.

CAUTION  "Caution" evidenzia un rischio di danneggiare la macchina. Non procedere oltre una nota "Caution" finchè le avvertenze specificate non siano completamente capite e conosciute.

CONSIDERAZIONI GENERALI SULLA SICUREZZA

 **Mettere in funzione l'apparecchio solo dopo aver controllato che l'installazione sia stata effettuata correttamente ed in conformità alle istruzioni del manuale.**

 **Parti di questa macchina si muovono durante il gioco, quindi ci sono posti dove le distanze tra la parte fissa e quella mobile cambiano. Ci sono avvisi "Warning" di tenere mani e piedi lontani dalle parti mobili, comunque se l'operatore crede che una persona sia in un qualche pericolo, deve avvisare quella persona.**

 **Gli avvisi "Warning" devono sempre essere conservati in buone condizioni e sostituiti se consumati, cosicché il cliente li possa leggere chiaramente.**

 **L'installazione, l'assistenza, le regolazioni e la manutenzione ordinaria devono essere eseguite solo da persone idonee e qualificate.**

 **Per una protezione costante contro il rischio di fuoco, assicurarsi che i fusibili sulle alimentazioni siano solo sostituiti con lo stesso tipo e caratteristiche. L'uso di altri fusibili o materiali è proibito.**

 **L'alimentatore all'interno del monitor rimane caldo ed ha zone di alto voltaggio anche se la macchina è stata spenta, c'è quindi la possibilità di bruciature o scosse elettriche. Fare attenzione a non toccare queste zone.**

 **Per prevenire possibili scosse elettriche dovute a difetti, questa macchina DEVE essere installata con un connettore sicuramente MESSO A TERRA.**

 **In caso il cavo di alimentazione di rete risultasse danneggiato deve essere sostituito immediatamente.**

 **Non accendere la macchina finchè la stessa non è stata installata completamente e correttamente.**

 **Prima di collegare la macchina alla rete, assicurarsi che la macchina sia preparata per il voltaggio corretto e che siano inseriti i fusibili adatti.**

NOTES D'INSTALLATION



NON ACCENDERE MAI la macchina finchè l'installazione non è stata completata.



Allo scopo di prevenire possibili scosse elettriche, la macchina deve essere obbligatoriamente collegata alla rete con un connettore messo a terra con connessioni sicure.



Perchè i clienti non siano feriti dal movimento del gioco, assicurarsi che ci siano almeno 500mm di distanza rispetto alle altre macchine o rispetto al muro.



Per evitare danni alla macchina durante la messa in opera, assicurarsi che il voltaggio della rete sia 230 volts AC.

Note: Il luogo di destinazione della macchina deve avere il pavimento liscio e si raccomanda di sistemare dei cuscinetti di gomma sotto i piedini di livellamento per prevenire lo scivolamento della macchina sul pavimento.

Note: Per garantire l'accesso all'alimentatore e alla scheda madre, assicurarsi che il retro del mobile principale sia separato dalla parete o da altre macchine di almeno 500mm.

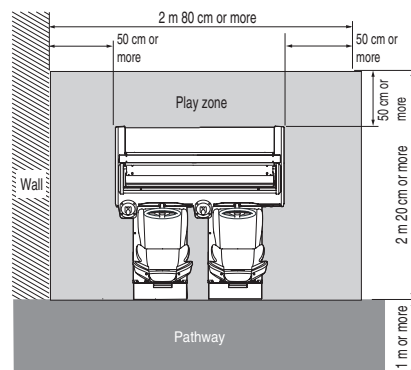

Il gioco è fornito di ruote per rendere più facile il suo spostamento. Fare attenzione quando si muove la macchina su una superficie inclinata.



La testata ha il baricentro spostato in avanti, è perciò importante che ci siano almeno 2 persone per montare o smontare la testata stessa.



La posizione di fissaggio della testata è molto alta, ed è importante che ci sia un mezzo disponibile per raggiungere tale altezza in sicurezza e senza allungamenti. (Ad esempio scalini, scale portatili etc.)



L'altezza totale della parte principale è 2050mm, fare attenzione ad eventuali ostacoli sopra la testata ovvero ad eventuali installazioni di luci.

RIMOZIONE E SOSTITUZIONE DI GRUPPI E PARTI STACCATE



L'installazione, l'assistenza, le regolazioni e la manutenzione ordinaria devono essere eseguite solo da persone idonee e qualificate.



Non apporre alcuna modifica alla macchina senza autorizzazione preventiva. Il fare questo può causare un pericolo non prevedibile.



Quando si rimpiazza o si riparano delle parti (incluse le viti) si possono usare solo parti approvate dalla Namco Europe Ltd.



Assicurarsi che la macchina sia SPENTA prima di incominciare qualsiasi lavoro di manutenzione (guasti, riparazioni etc.)



Se state per iniziare un lavoro non descritto in questo manuale, contattate il vostro distributore per istruzioni poichè non si accetta alcuna responsabilità per danni o ferite.



Parti dell'alimentatore e del monitor rimangono caldi o portano alta tensione anche dopo aver spento l'apparecchiatura e possono causare bruciate o scosse elettriche. Attenzione a non toccare queste parti accidentalmente.



Assicurarsi che la macchina abbia l'interruttore nella posizione OFF prima di inserire o disinserire qualsiasi connettore o spina.



Quando vengono rimossi i connettori principali dalla macchina oppure la spina dell'alimentazione dalla parete bisogna sempre afferrare il connettore e non il cavo.



Ingen del av denne utgivelsen må reproduseres av noen mekaniske, fotografiske eller elektroniske prosesser, eller i form av fotografiske opptak, og ikke kan det lagres i et gjenvinnbart system, sendt eller kopiert for offentlig eller privat bruk, uten tillatelse fra NAMCO EUROPE LIMITED.

Da informasjonen i denne manualen er gitt i god tru og var korrekt da den ble utgitt, tillegger NAMCO EUROPE LIMITED seg retten til å lage forandringer uten varsel.

Denne maskinen er produsert i samsvar med direktiver framsatt av det Europeiske samfunn. Maskinen er testet og samsvarer med direktivene 89/336/EEC og 72/23/EEC med anvendelse av EN55014-1, EN55014-2 og EN60335-2-82 standarder (se i begynnelsen av manualen), og derfor bærer CE merket. Hvilken som helst forandring eller modifisering må skje etter direktivene satt av det Europeiske samfunn. Uautoriserte forandringer på dette produktet, kan motstride disse direktivene.

Under noen forhold av ekstreme ytre forstyrrelser, f.eks radio sendere, elektronisk utladning eller transiente spenninger, kan man regne med noe senket ytelse. Men maskinen vil oppnå normal ytelse når kilden til forstyrrelsene opphører eller er fysisk fjernet.

Merk:- Hvis spilllets prosessor resettes p.g.a et kutt eller reduksjon av hovedspenningen kan oppsparte kreditt på spillet forsvinne.

Dette spillet er ikke en maskin som er definert ved Maskin direktivet 89/392/EEC.

Sikkerhets advarsel.

For å bruke denne maskinen uten noe form for fare, sørg for å lese denne manualen nøye før installasjon, justeringer eller bruk av maskinen.

Når eieren av denne maskinen overlater avmontering, installasjon, justering eller rutine vedlikehold til en annen person, skal eieren forsikre seg om at denne personen leser de passende forsiktighetsreglene og relevante deler av manualen før han starter på arbeidet.

For å forhindre at ulykker inntreffer når maskinen er i drift, følg strengt teksten om sikkerhet som beskrevet nedenfor.

Denne manualen sammen med installasjons manualen (hvor det er anvendelig) er en intrigert del av utstyret og må være tilgjengelig for drift- og servispersonell til alle tider.

Denne maskinen er bare for innendørs bruk og skal bare benyttes etter mente hensikter.

Namco Ltd. bærer intet ansvar ved ulykker, kvestelse eller skade som følger av uautoriserte forandringer, eller for uriktig bruk av maskinen.











Sikkerhets beskjeder.

Følgende sikkerhets punkter er brukt ut denne manualen. Gjør deg kjent med disse punktene og deres mening før installasjon, service eller du utfører noen innstillinger på denne maskinen.

ADVARSEL  Advarsel innebærer en risiko som kan føre til kvestelse eller død. Ikke fortsett utover advarslen før den er ordentlig forstått og mottiltak er igangsatt.

FORSIKTIG  Forsiktig innebærer en risiko som kan medføre skade på maskinen. Ikke fortsett utover advarslen før den er ordentlig forstått og mottiltak er igangsatt.

VANLIGE SIKKERHETSTILTAK

-  **Bruk bare denne maskinen etter å ha kontrollert at den er korrekt installert ifølge manualen.**
-  **Deler av denne maskinen er i bevegelse under spill, det er derfor plasser hvor avstanden mellom de stillestående deler og bevegelige deler forandres. Det er plassert skilt med advarsel for å holde hender og føtter borte fra bevegelige deler, men uansett skal operatøren varsle vedkommende hvis han føler at han er i noen form for fare.**
-  **Advarsel skiltene må bestandig holdes i skikket stand og eventuelt byttes ut hvis det oppstår skade på dem, slik at kunden uten vanskelighet kan lese dem.**
-  **Installasjon, service, justering eller rutine vedlikehold skal bare utføres av kvalifiserte personer.**
-  **For fortsatt beskyttelse mot brann, forsikre deg at hoved sikringen bare byttes ut med en av samme type og verdi. Bruk av andre sikringer eller materiale er forbudt.**
-  **Strømforsyningen inne i monitoren vill være varm og ha områder med høy spenning selv om maskinen har blitt slått av. og det er muligheter for skader og elektriske sjokk. Vær forsiktig så du ikke berører disse områdene.**
-  **For å forhindre mulige elektriske sjokk grunnet funksjonsfeil, må denne maskinen være ordentlig jordet.**
-  **Hvis ledningen til hoved strømforsyningen skades må den straks byttes ut.**
-  **Ikke slå på maskinen før den er korrekt installert.**
-  **Før du kopler maskinen til strømmettet, forsikre deg om at maskinen innstilt for den korrekte spenningen og de riktige sikringene benyttes.**

MERKNADER VED INSTALLASJON



Slå ALDRI på maskinens strømforsyning før installasjonen er fullført.



For å forhindre eventuelle elektriske sjokk, forsikre deg om at maskinen er koplet til et strømmnett med ordentlig jording.



For å forhindre at kundene blir skadet av spilllets bevegelige deler, forsikre deg om at det er minst 500mm avstand mellom andre maskiner eller vegger.



For å forhindre skade på maskinen p.g.a. feil bruk, sørg for at spenningen til hoved strømforsyningen er 230Volt AC.

MERKNADER: Hvis plassen hvor spillet skal plasseres har polerte gulv anbefales det at du benytter gummi sko under nivå justeringene, for å forhindre at maskinen kan flytte på seg.

MERKNADER: For å få adgang til strømforsyningen og CPU-kort, forsikre deg om at bakparten av hoved kabinettet er skilt fra vegger eller andre maskiner med minst 500mm.

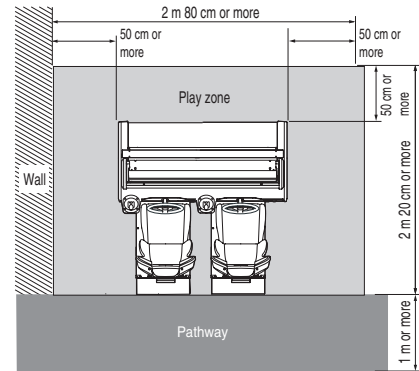

Spillet har montert hjul for å gjøre det letter å flytte på. Hver forsiktig når det skal flyttes på en hellende overflate.



Hoved enheten i spillet har tyngdepunktet i fronten, så det er viktig at minst 2 personer blir brukt til å montere eller flytte denne enheten.



Monterings posisjonen til hoved enheten er veldig høy, og det er viktig at denne høyden nås sikkert, uten at man må strekke seg. Benytt deg av hjelpemiddel. (f.eks sto, krakk, gardintrapp osv)



Den totale høyden på hoved enheten er 2050mm. vær forsiktig med høye hindringer som f.eks lysrør.



Installasjon, service,justering eller rutine skal bare utføres av kvalifiserte personer



Ikke lag noen forandringer på denne maskinen uten godkjenning. Dette kan medføre uforutsette farer.



Bare deler spesifisert av Namco Europe Ltd. skal benyttes ved utskifting eller reparasjon av deler (dette reparasjon osv.)



Forsikre deg om at strømmen er slått av før du påbegynner noe som heist vedlikeholdsarbeid (feilsøking, reparasjon osv.)



Hvis du utfører arbeid som ikke er beskrevet i denne manualen, ta kontakt med din distributor for instruksjon da ikke noeansvar vill bli akseptert for skade på maskin eller på personer.



Deler av strømforsyningen og monioren er fortsatt varm eller bærer høye spenninger selv etter strømmen er slått av og kan forårsake skader eller elektriske sjokk. Forsikre deg om at du ikke berører disse delene.



Forsikre deg om at maskinen er slått av før du koplek sammen eller tar fra hverandre pluggen eller koplekninger.



Når du fjerner hoved koplekningen fra maskinen, eller hoved pluggen fra støpselet, ta bestandig tak i pluggen og ikke ledningen.



Niets uit deze publikatie mag worden gereproduceerd door enig mechanisch, fotografisch of elektronisch proces, of in de vorm van een fonografische opname, noch mag het opgeslagen worden in een retrieval systeem, doorgezonden of anderszins gekopieerd voor publiek of privégebruik, zonder toestemming van Namco Europe Limited.

Ofschoon de informatie in deze handleiding in goed vertrouwen is gegeven en nauwkeurig was ten tijde van het drukken, houdt Namco zich het recht voor om veranderingen en aanpassingen te maken zonder bericht.

Deze machine is geproduceerd volgens Richtlijnen van de Europese Gemeenschap, en is getest en is in overeenstemming met de Richtlijnen 89/336/EEC en 72/23/EEC door de toepassing van de standaards EN55014-1, EN55014-2 en EN60335-2-82 (zie voorin de handleiding) en draagt als zodanig het CE-merk. Enige veranderingen of aanpassingen aan deze machine dienen in overeenstemming te zijn met de Richtlijnen van de Europese Gemeenschap. Enige ongeautoriseerde veranderingen aan dit produkt kunnen in strijd zijn met deze Richtlijnen.

Onder sommige omstandigheden van extreme externe storingen, bijv. radiotransmissies, electrostatische ontladingen of pieken op het net, kan prestatieruggang optreden. De machine zal echter normaal presteren zodra de storingsbron gestopt of verwijderd is.

Let op: - als de spelprocessor reset a.g.v. een onderbreking of vermindering van de netstroom, dan kunnen opgebouwde credits verloren gaan.

Dit spel is niet een machine zoals omschreven in de Machinery Directive 89/392/EEC.

Veiligheidsopmerkingen

Om deze machine veilig te kunnen gebruiken, dient vóór installatie, aanpassing of gebruik van deze machine, de Bedieningshandleiding zorgvuldig gelezen te worden.

Telkens wanneer de eigenaar van deze machine de demontage, installatie, aanpassing of routine-onderhoud toevertrouwd aan een andere persoon, dient de eigenaar er voor te zorgen dat deze persoon de juiste voorzorgsmaatregelen en relevante gedeeltes uit de handleiding leest voordat hij begint.

Om er voor te zorgen dat geen ongelukken gebeuren als de machine gebruikt wordt, dienen onderstaande veiligheidsaanwijzingen zorgvuldig opgevolgd te worden.

Deze handleiding maakt samen met de installatiehandleiding (waar van toepassing) een integraal deel uit van de apparatuur en moet te allen tijde ter beschikking staan van exploitatie- en onderhoudspersoneel.

Deze machine is alleen bedoeld voor gebruik binnenshuis en dient alleen gebruikt te worden voor bedoelde doeleinden.

Namco Ltd. is niet verantwoordelijk voor ongelukken, letsel of schade die voortkomt uit ongeoorloofde veranderingen aan of onjuist gebruik van deze machine.

Veiligheidsopmerkingen

De volgende veiligheidsopmerkingen worden overal in deze handleiding gebruikt. Maak uzelf vertrouwd met deze opmerkingen en hun betekenis vóór installatie, het plegen van onderhoud of het aanbrengen van aanpassingen aan deze machine.

WAARSCHUWING



Waarschuwing geeft een gevaar aan dat zou kunnen resulteren in letsel of de dood. Ga niet verder dan een waarschuwingsofmerking totdat de aangegeven omstandigheden volledig begrepen zijn en hieraan voldaan is.

VOORZICHTIG



Voorzichtig geeft een gevaar aan dat zou kunnen resulteren in schade aan de machine. Ga niet verder dan een voorzichtigheidsopmerking totdat de aangegeven omstandigheden volledig begrepen zijn en hieraan voldaan is

ALGEMENE VEILIGHEIDSOVERWEGINGEN



Stel deze machine alleen in gebruik nadat gecontroleerd is of de machine correct en overeenkomstig de handleiding is geïnstalleerd.



Gedeeltes van deze machine bewegen tijdens het spel, waardoor er plaatsen zijn waar de afstand tussen het stilstaande gedeelte en de bewegende sectie verandert. Er zijn waarschuwingstickers om handen en voeten van bewegende delen af te houden; als de exploitant echter van mening is dat iemand in gevaar is, dan dient hij deze persoon dienovereenkomstig te waarschuwen.



Als zich een fout of probleem voordoet met de machine, dan dient de machine onmiddellijk stopgezet en het probleem verholpen te worden voordat de machine verder gebruikt wordt.



Installatie, service, aanpassingen of routine-onderhoud dient alleen uitgevoerd te worden door hierin bekwame personen.



Om blijvende bescherming tegen brandgevaar te garanderen, dient ervoor gezorgd te worden dat de netzekeringen alleen vervangen worden door zekeringen van hetzelfde type en dezelfde sterkte. Het gebruik van andere zekeringen of ander materiaal is verboden.



De voeding in de monitor blijft warm en er kunnen componenten elektrisch geladen blijven ondanks dat de machine UITgeschakeld is, waardoor er brandwonden of elektrische schokken kunnen worden opgelopen. Ben voorzichtig en raak deze delen niet aan.



Om mogelijke elektrische schokken a.g.v. storingen te voorkomen, MOET deze machine voorzien zijn van een goed vastzittende aardstekker.



Mocht het netsnoer op enig moment beschadigd worden, dan moet deze onmiddellijk vervangen worden.



Zet de machine niet AAN totdat deze correct is geïnstalleerd.



Voordat de machine op het lichtnet wordt aangesloten, dient gecontroleerd te worden of de machine op het correcte voltage staat afgesteld en of de correcte zekeringen zijn aangebracht.

Opmerkingen aangaande Installatie



Sluit de machine nooit aan op de stroomtoevoer totdat de installatie is voltooid.



Om mogelijke elektrische schokken te voorkomen, dient ervoor gezorgd te worden dat de machine middels een goed vastzittende aardstekker op het lichtnet is aangesloten.



Om ervoor te zorgen dat klanten niet gewond raken door de beweging van het spel, dient ervoor gezorgd te worden dat er minimaal 500mm ruimte is tussen andere machines of muren.



Om schade aan de machine door verkeerd gebruik te voorkomen, dient ervoor gezorgd te worden dat het voltage van het lichtnet 230volts AC bedraagt.

OPMERKING: Als de machine op een gladde ondergrond wordt gebruikt, is het raadzaam rubber matjes onder de stelvoetjes te bevestigen om te voorkomen dat de machine over de vloer gaat glijden.

OPMERKING: Om toegang te krijgen tot de voeding- en de CPU-assemblies, dient ervoor gezorgd te worden dat de achterkant van het kabinet minimaal 500mm verwijderd is van de muur of andere machines.

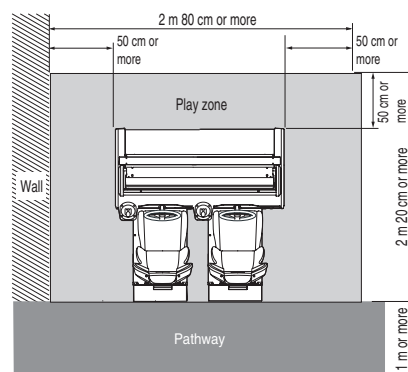

Het spel is voorzien van wieltjes, waardoor het gemakkelijker is om te verplaatsen. Wees voorzichtig als de machine op een hellend vlak gereden wordt.



Het zwaartepunt van de Header Assembly ligt aan diens voorkant, waardoor het belangrijk is dat minimaal 2 personen de Header Assembly aanbrengen of verwijderen.



De Header Assembly moet op een hoge positie geplaatst worden en het is dus belangrijk dat deze hoogte veilig kan worden bereikt zonder veel te strekken. (bijv. middels een trap of een kruk)



De hoogte van het hoofdgedeelte is 2050mm: kijk dus uit voor obstakels zoals lampen.

Verwijderen en vervangen van Assemblies en onderdelen



Installatie, service, aanpassingen of routine-onderhoud dient alleen uitgevoerd te worden door hierin bekwame personen.



Maak geen veranderingen aan deze machine zonder goedkeuring vooraf. Dit kan onvoorzien gevaar opleveren.



Alleen onderdelen die door Namco Europe Ltd. zijn gespecificeerd dienen gebruikt te worden bij het vervangen of repareren van onderdelen (incl. schroeven).



Zorg ervoor dat de machine UITgeschakeld is voordat er enig onderhoudswerk wordt verricht (troubleshooting, reparaties etc.)



Bij het verrichten van werkzaamheden die niet in deze handleiding staan beschreven, dient voor instructies altijd contact opgenomen te worden met de verdeler aangezien geen verantwoording wordt genomen voor schade of letsel.



Delen van de voeding en de monitor blijven warm of behouden hoogspanning zelfs nadat de machine UITgeschakeld is en zouden verbrandingen of elektrische schokken kunnen veroorzaken. Ben voorzichtig en raak deze delen niet per ongeluk aan.



Zorg ervoor dat de machine is UITgeschakeld voordat pluggen of connectors ingestoken of uitgetrokken worden.



Als het netsnoer uit de machine of uit het stopcontact verwijderd wordt, dient altijd de stekker vastgepakt te worden en niet het snoer.



Nenhuma parte desta publicação poderá ser reproduzida por processos mecanográficos, fotográficos, electrónicos ou ainda sob a forma de gravação sonora nem tão pouco poderá ser gravada através de sistemas informáticos transmissíveis ou de outra forma copiados para uso público ou privado sem autorização expressa da NAMCO EUROPA LIMITADA.

A informação contida neste manual foi fornecida de boa fé, sendo rigorosa na altura da sua publicação. A NAMCO EUROPA LIMITADA, reserva-se o direito de proceder a mudanças e alterações sem qualquer aviso prévio.

Esta máquina foi fabricada de acordo com as Directivas Comunitárias Europeias e tem sido testada em conformidade com as seguintes Directivas: 89/336/EEC e 72/23/EEC através dos requerimentos normativos, EN55014-1, EN55014-2 e EN60335-2-82 (ver capa frontal do manual) e como tal sustenta o certificado de marca de CE. Quaisqueres alterações ou modificações efectuadas nesta máquina deverão ser em conformidade com as Directivas da Comunidade Europeia. Quaisqueres alterações não autorizadas a este equipamento poderão infringir tais Directivas.

O funcionamento normal desta máquina, poderá ser afectado debaixo de algumas condições extremas de interferências externas tais como; transmissões via radio, descargas electroestáticas e passagens de corrente na rede de alimentação. Contudo o seu funcionamento normal será restabelecido logo que a fonte de interferências tenha cessado ou tenha sido neutralizada.

Nota :- Se o processador de jogo for inicializado devido a uma interrupção ou quebra da corrente principal, quaisquer creditos obtidos poderão desaparecer.

Este jogo por si só não constitui uma máquina tal como defenido pelas Directivas de Maquinaria de 89/392/EEC8.

AVISOS DE SEGURANÇA

Afim de usar esta máquina com segurança, certifique-se que lê este manual de operador atentamente antes de proceder á montagem e afinação ou uso da mesma.

Sempre que o proprietário desta máquina confiar a desmontagem, instalação, afinação ou manutenção preventiva da mesma a outra pessoa, deverá este assegurar - se que a pessoa em questão lê as precauções apropriadas e capitulos relevantes deste manual antes de iniciar o trabalho.

Afim de evitar qualquer tipo de acidente quando a máquina estiver em funcionamento, deverá seguir rigorosamente os procedimentos de segurança descritos abaixo.

Este manual juntamente com o manual de instalação (aonde aplicavel), contituem parte integrante do equipamento e deverão estar sempre disponiveis ao operador e pessoal tecnico de assistência.

Esta máquina destina-se a ser operada em espaços interiores apenas e a sua utilização deve circunscrever-se somente aos fins previstos.

A Namco Ltd. declina qualquer responsabilidade por acidentes, ferimentos ou danos resultantes de modificações não autorizadas ou uso indevido desta máquina.

AVISOS DE SEGURANÇA

Os seguintes avisos de segurança são usados através de todo o manual. Familiarize-se com cada um destes avisos e respectivos significados antes de instalar, assistir ou efectuar qualquer afinação nesta máquina.

PERIGO



Perigo revela uma situação anormal que poderá resultar em ferimentos ou morte. Não avance para além de um aviso de Perigo sem que todas as condições indicadas estejam completamente esclarecidas e resolvidas.

CAUTELA



Cautela revela uma situação anormal que poderá resultar em danos materiais para a máquina. Não avance para além de um aviso de Cautela sem que todas as condições indicadas estejam completamente esclarecidas e resolvidas.

AVISOS DE PERIGO



Esta máquina só deverá ser colocada em funcionamento após ter sido verificado que se encontra instalada correctamente e de acordo com o manual de instruções.



Algumas partes componentes desta máquina movem-se durante a acção de jogo, porconsequente existem lugares aonde a distância entre a secção fixa e móvel altera-se. Existem avisos para manter as mãos e os pés afastados da zona de perigo móvel, contudo caso o operador se aperceba de alguma pessoa em perigo, deverá avisar a mesma em conformidade.



Os avisos de perigo devem ser sempre mantidos em boas condições de leitura de forma a permitir uma leitura clara por parte do utilizador, caso se encontrem danificados deverão ser substituídos.



A montagem, assistência e afinações ou manutenção de rotina desta máquina, deverão ser somente executadas por tecnicos ou pessoas devidamente qualificadas para o efeito.



Afim de garantir uma protecção anti - fogo permanente nesta máquina, certifique-se que os fusíveis de protecção são sempre substituídos por fusíveis de igual valor ou calibre aos de origem. O uso de outro tipo de fusíveis ou material é proibido.



A fonte de alimentação do monitor encontrar-se-à quente, tendo zonas de alta voltagem, mesmo após a máquina ter sido desligada. Deste facto poderá resultar a ocorrência de queimaduras ou choques electricos. Seja cuidadoso para evitar contacto com estas zonas.



Esta máquina deve estar sempre equipada com uma ficha com circuito de protecção à Terra, afim de evitar possiveis choques electricos, caso surja uma falha no sistema.



Se a qualquer altura o cabo de alimentação principal ficar danificado, deverá ser imediatamente substituído.







Não ligar a máquina sem que esta tenha sido correctamente instalada.



Antes de ligar a máquina à tomada da rede de alimentação principal, certifique-se de que a máquina está preparada para a voltagem correspondente e de que também se encontra protegida com os fusíveis apropriados.





NOTAS SOBRE A INSTALAÇÃO

-  **NUNCA** ligar a maquina sem que a instalação esteja completamente finalizada.
-  Afim de evitar possiveis choques electricos, certifique-se que a maquina está ligada à rede de alimentação com uma ficha protegida com circuito de terra.
-  Afim de evitar ferimentos pessoais nos clientes, provocados pelo movimento da maquina, certifique-se que existe pelo menos 500mm de separação entre outras maquinas ou paredes.
-  Afim de evitar danos na maquina causados por falhas de operação, certifique-se que a voltagem da rede de alimentação principal é de 230volt AC.

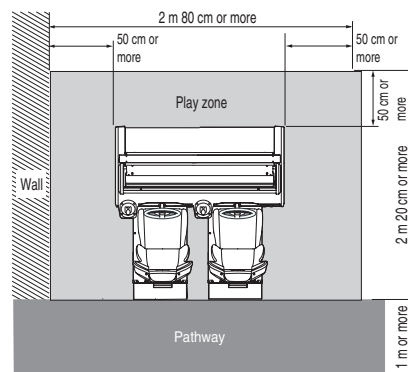







NOTAS : Se esta maquina estiver colocada sobre um chão polido, recomenda-se a utilização de tapetes de borracha debaixo dos pés niveladores, afim de prevenir a maquina de deslizar no chão.

NOTAS : Quando precisar de aceder à fonte de alimentação e às placas (CPU), certifique-se que a parte trazeira do móvel central está separada da parede ou de outras maquinas pelo menos 500mm afim de ganhar espaço de manobra.



-  Esta maquina está equipada com rodas afim de facilitar a sua deslocação tenha cuidado ao mover a maquina num plano inclinado.
-  O bloco Superior (Cabeça) tem o centro de gravidade para a frente, por conseguinte é importante que pelo menos sejam utilizadas duas pessoas para montar ou desmontar este Bloco Superior.
-  A posição do bloco superior quando montado na maquina é muito alta. Torna-se importante ter meios seguros de alcance, tais como; escadotes ou escadas afim de evitar riscos desnecessários.
-  A altura total do bloco principal, é de 2050mm, tenha cuidado com qualquer tipo de obstruções existentes em altura como por exemplo; calhas electricas ou candeiros.

SUBSTITUIÇÃO E MONTAGEM DE PEÇAS

-  A montagem, assistência e afinações ou manutenção de rotina desta maquina, deverão ser somente executadas por tecnicos ou pessoas devidamente qualificadas para o efeito.
-  Não faça qualquer tipo de alteração prévia nesta maquina sem aprovação prévia. Se tal acontecer poderá provocar danos e perigos imprevisíveis.
-  A substituição ou reparação de peças deverá ser feita apenas com peças de origem ou especificadas pela "Namco Europa Ltd." (incluindo parafusos)
-  Certifique-se que a maquina se encontra desligada sempre que iniciar qualquer tipo de trabalho de manutenção. (identificação de avarias, reparação etc.)
-  Caso esteja a efectuar um trabalho não descrito neste manual, certifique-se que contacta o seu distribuidor para obter instruções, caso contrário não serão aceites responsabilidades por danos causados ou ferimentos.
-  Algumas zonas da fonte de alimentação e do monitor ficam quentes e transportam correntes de alta voltagem, mesmo depois de a maquina ter sido desligada, podendo causar queimaduras e choques electricos. Tome cuidado para não tocar acidentalmente estas zonas.
-  Certifique-se que a maquina está desligada antes de ligar ou desligar qualquer tipo de fichas ou junções.
-  Quando desligar a ficha principal da maquina ou a ficha do cabo de alimentação das tomadas da parede, deverá sempre agarrar na ficha e nunca puxar pelo cabo da mesma.



Ingen del av denna publikation får reproduceras, varken fotografiskt, elektroniskt eller i någon form av ljudinspelning. Det får inte heller lagras i något återvinningssystem, översändas eller på annat sätt kopieras för offentlig eller privat användning, utan tillstånd från NAMCO EUROPE LIMITED.

Eftersom informationen i denna manual lämnas ut i god tro och var korrekt när den trycktes, reserverar sig NAMCO EUROPE LIMITED för ändringar.

Denna maskin har tillverkats enligt direktiv från europeiska unionen, är testad och uppfyller direktiven enligt 89/336EEC och 72/23/EEC med tillämpning av EN55014-1, EN55014-2 och EN60335-2-82 standard (se manualens framsida) och bär därmed också CE-märket. Varje förändring eller modifiering av denna maskin måste ske i överens-stämmelse med EU-direktiven. En förändring i denna produkt, som inte är auktoriserad, kan strida mot dessa direktiv.

Under vissa omständigheter när det gäller extrema externa störningar, t ex radiosändningar, elektrostatiske urladdningar eller nätburna strömstörningar, kan resultera i en något nedsatt funktion. Maskinen kommer dock att återgå till normal funktion, så snart störningen har upphört eller avlägsnats

OBS! Om spelprocessorn startar om till följd av ett avbrott eller reducering av strömmen kan registrerade krediter gå förlorade.

Detta spel är inte en maskin enligt definitionen i Maskindirektivet 89/392/EEC

SÄKERHETS VARNING

För att maskinen ska kunna användas på ett säkert sätt, ska manualen läsas noggrant före installation, användning eller justering.

Om ägaren till maskinen anförtror någon annan person att montera isär, installera, justera maskinen eller utföra rutinunderhåll, ska ägaren försäkra sig om att denna person läser om försiktighetsåtgärder och tillämpliga delar av denna manual innan arbetet påbörjas.

För att förhindra att någon olycka händer när maskinen är igång, måste säkerhetspunkterna beskrivna nedan följas strikt.

Denna manual tillsammans med installationsmanualen (när tillämpligt) utgör en integrerad del av utrustningen och måste vara ständigt tillgänglig för operatörer och service personal.

Maskinen är avsedd för inomhusbruk och ska endast användas för detta ändamål.

Namco Ltd. bär inget ansvar för olyckor eller skador som orsakats av icke auktoriserade ändringar i maskinen eller felaktigt användande av densamma.

SÄKERHETSANVISNINGAR

Säkerhetsanvisningarna nedan används genomgående i manualen. Gör dig förtrogen med varje anvisning och dess innebörd innan installation, service eller justeringar görs på denna maskin.

VARNING













"Varning" anger en fara som skulle kunna skada eller förorsaka dödsfall. Fortsätt inte vid en sådan varningsanvisning innan de påvisade förhållandena är förstådda och åtgärdade i sin helhet.

OBSERVERA







"OBSERVERA" anger en fara som skulle kunna förorsaka skada på maskinen. Fortsätt inte vid en sådan varningsanvisning innan de påvisade förhållandena är förstådda och åtgärdade i sin helhet.

ALLMÄNNA SÄKERHETSBEAKTANDEN

-  Sätt inte igång maskinen utan att ha kontrollerat att den är korrekt installerad och i överensstämmelse med manualen.
-  Eftersom delar av maskinen rör sig under spel finns det ställen där avståndet mellan den stationära delen och den rörliga ändras. Det finns varningsanvisningar om att hålla händer och fötter borta från rörliga delar, men skulle operatören anse att en person är i någon som helst fara, ska personen ifråga varnas.
-  Varningsanvisningarna måste alltid hållas i gott skick och ersättas när de blir slitna, så att kunderna kan läsa dem tydligt.
-  Installation, service, justeringar eller rutinunderhåll ska endast utföras av en för ändamålet kvalificerad person.
-  För kontinuerligt skydd mot brandfara, ska man försäkra sig om att huvudsäkringarna endast ersätts med samma typ och specifikationer. Användandet av andra säkringar eller material är förbjuden.
-  Strömförsörjningen inne i monitorn håller sig varm och har områden med hög spänning, även när maskinen stängts av och det finns risk för brännskada eller elektriska stötar. Var försiktig och vidrör aldrig sådana områden.
-  För att förhindra en eventuell elektrisk stöt förorsakad av fel, MÅSTE maskinen vara försedd med säkert ansluten JORDAD kontakt.
-  Om strömförsörjningskabeln på något sätt skadas, måste den bytas ut omedelbart.
-  Vrid inte strömbrytaren till ON innan maskinen är korrekt installerad.
-  Innan strömmen sätts på till maskinen, måste man försäkra sig om att den är inställd på rätt spänning och att rätt säkringar är isatta.





ATT BEAKTA VID INSTALLATION

-  Sätt aldrig på strömmen på maskinen innan installationen är klar.
-  För att förhindra elektriska chocker, försäkra dig om att maskinen kopplas till strömförsörjning med jordad kontakt
-  För att undvika skador av spelets rörelser, försäkra dig om att det finns ett avstånd på minst 500 mm till annan maskin eller vägg.
-  För att undvika skador på maskinen p g a felaktigt handhavande, försäkra dig om att strömstyrkan är 230 volt AC.

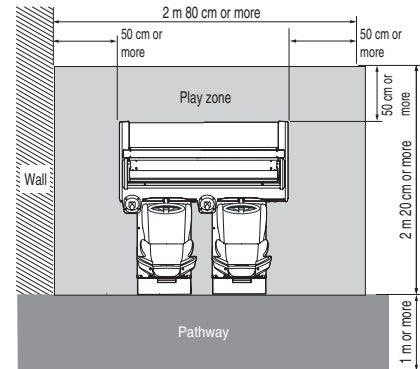







OBSERVERA: Om maskinen är placerad på ett polerat golv, rekommenderas att placera gummbrickor under nivåjusteringen för att förhindra att maskinen glider på golvet.

OBSERVERA: För att kunna komma åt strömförsörjningen och CPU, se till att baksidan av huvudkabinettet är placerat minst 500 mm från vägg eller annan maskin.



-  Spellet är försett med hjul för att underlätta förflyttningar. Var försiktig om spelet ska flyttas på en sluttande yta.
-  Toppskylten har tyngdpunkten framtill, därför är det viktigt att minst 2 personer sätter dit eller tar bort den.
-  Toppskyltens placering är mycket högt upp och det är viktigt att sådana hjälpmedel används så att man når upp utan att sträcka sig (t ex trappstege, pall osv).
-  Den totala höjden är 2050mm, tänk på eventuella högt placerade hinder, t ex lampor.

ATT TA BORT ELLER BYTA UT ENHETER OCH DELAR

-  Justeringar och underhåll på denna maskin skall endast utföras av kvalificerad personal.
-  Gör inga ändringar på denna maskin utan ett godkännande i förväg. Detta kan förorsaka oförutsägbar fara.
-  Endast delar som är specificerade av Namco Europe Ltd. ska användas vid utbyten eller reparation av delar (inklusive skruvar).
-  Försäkra dig om att strömmen är avstängd innan underhållsarbete påbörjas (felsökning, reparationer etc.)
-  Om arbete ska utföras som inte är beskrivet i denna manual, är det viktigt att kontakta återförsäljaren för instruktioner eftersom inget ansvar accepteras för åverkan eller personskador.
-  Delar av strömförsörjningen och monitorn är varma och strömbärande även efter strömmen stängts av och kan orsaka brännskador eller elektriska stötar.
-  Försäkra dig om att maskinen är avstängd innan kontakter sätts i eller tas ur.
-  När kontakten tas ur maskinen eller ur väggen, ta alltid tag i kontakten och inte i sladden.



Tästä julkaisusta ei saa ottaa missään muodossa kopioita yksityis- tai julkiseen käyttöön ilman **NAMCO EUROPE LIMITED**:in lupaa.

Tässä ohjekirjassa olevat tiedot pitävät julkaisuhetkellä paikkansa. NAMCO EUROPE LIMITED:illä on kuitenkin oikeus muutoksiin ilman erillistä ilmoitusta.

Tämä laite on valmistettu EC direktiivien mukaisesti. Se on testattu ja todettu noudattavan seuraavia direktiivejä: 89/336/EEC ja 72/23/EEC (EN55014-1, EN55014-2 ja EN 60335-2-82 standardit). Näin ollen tämä laite on varustettu CE-merkinnällä. Kaikki tähän laitteeseen kohdistetut muutokset on tehtävä EC- direktiivien mukaisesti. Mikä tahansa valtuuttamattoman huoltomiehen tekemä muutos voi olla direktiivien vastainen.

Laitteen toiminta voi häiriintyä määrättyissä olosuhteissa, jotka johtuvat äärimmäisistä ulkoisista sähköhäiriöistä, kuten radiolähetys, elektrostaattinen purkaus tai vahvavirrasta syntynyt häiriö. Toiminta normalisoituu kuitenkin heti, kun ulkoinen sähköhäiriö on poistettu.

Huom:- Jos peliprosessori resetoituu sähkökatkoksen tai vastaavan johdosta, voivat kaikki pelivaraukset hävitä.

Tämä laite ei ole 89/392/EEC direktiivien mukainen kone.

Turvallisuusvaroitukset

Tämän laitteen turvallinen käyttö edellyttää käyttöohjekirjan huolellista lukemista ennen laitteen asennusta, säätöä tai käyttöä. Jos tämän laitteen omistaja antaa jollekin toiselle osapuolelle tehtäväksi purkaa, asentaa, säätää tai muuten huoltaa laitetta, on omistajan varmistettava siitä, että toinen osapuoli on lukenut ja ymmärtänyt käyttöohjekirjan oleelliset osat ennen työhön ryhtymistä.

Turvallisuusohjeita on seurattava tarkoin vahinkojen välttämiseksi laitteen ollessa käytössä .

Tämä ohje sekä mahdollinen asennusohje muodostavat laitteiston oleellisen osan ja on siksi aina oltava huolto- ja käyttöhenkilökunnan käytettävissä.

Tämä laite on tarkoitettu vain sisätiläkäyttöön. Sitä ei saa käyttää muihin tarkoituksiin.

Namco Ltd ei vastaa niistä onnettomuuksista, loukaantumisista tai vahingoista, jotka johtuvat laitteeseen ilman Namco Ltd:n lupaa tehdyistä muutoksista laitteen vääristä käytöstä.











Turvallisuusohjeet

Tässä käyttöohjekirjassa on käytetty seuraavia turvallisuuteen liittyviä huomautuksia. Tutustu jokaiseen näistä. Älä asenna, huolla tai säädä laitteistoa, ennen kuin olet täysin ymmärtänyt mitä ne tarkoittavat.

VAARA  "Vaara" tarkoittaa uhkaa, joka voi johtaa loukkantumiseen tai kuolemaan, Älä koskaan ohita Vaara-merkintää, ennenkuin ohjeissa esitetyt olosuhteet on ymmärretty täysin.

VAROITUS  "Varoitus" tarkoittaa uhkaa, joka voi johtaa laitteen vioittumiseen. Älä koskaan ohita Vaara-merkintää, ennenkuin ohjeissa esitetyt olosuhteet on ymmärretty täysin.

YLEISET TURVALLISUUNÄKÖKODAT

-  **Varmista, että laite on asennettu oikein ja ohjekirjan mukaisesti ennen käyttöönottoa.**
-  **Laite sisältää toimiessaan liikkuvia osia. On paikkoja, jossa liikkuvien osien ja paikalla pysyvien osien välimatka muuttuu. Tällaisissa paikoissa on varoitustaulut, joissa kehoitetaan pitämään käsiä ja jalkoja poissa liikkuvista osista. Jos käyttäjä on sitä mieltä, että joku henkilö on vaarassa, on käyttäjän velvollisuus varoittaa vaarassa olijaa.**
-  **Varoitustaulut on pidettävä hyvässä kunnossa. Jos ne ovat kuluneet, ne on ehdottomasti vaihdettava, jotta asiakkaalla olisi mahdollisuus lukea niitä selvästi.**
-  **Vain riittävän ammattipätevyyden omaava henkilö saa suorittaa asennus-, huolto-, säätö- tai muita laitteeseen kohdistuvia rutiinitoimenpiteitä.**
-  **Jotta palovaaraa ei syntyisi, saa pääsulakkeita vaihtaa vain samankokoisiin sulakkeisiin. Muiden sulakkeiden tai materiaalin käyttö on ehdottomasti kielletty.**
-  **Monitorin sisällä oleva virtalähde pysyy kuumana ja siinä on alueita, joissa on korkeajännite vaikka laite on kytketty pois päältä. Palovammojen tai sähköiskun saaminen on mahdollista. Älä koske näihin alueisiin.**
-  **Sähköiskujen välttämiseksi vikatapauksissa, laite on ehdottomasti kytkettävä maadoitetulla johdolla maadoitettuun pistorasiaan.**
-  **Vioittunut verkkojohto on välittömästi vaihdettava.**
-  **Älä kytke laitetta päälle, ennen kuin se on oikein asennettu.**
-  **Varmista ennen verkkoon kytkemistä, että virtalähteen jännitteen asetus on asetettu oikealle jännitteelle ja että siinä on oikeat sulakkeet.**

ASENNUSHUOMIOITA



Älä koskaan kytke laitetta päälle ennen kuin asennus on suoritettu loppuun.



Tämän laitteen virtalähde on kytkettävä maadoitetulla johdolla maadoitettuun pistorasiaan, jotta sähköiskun vaaraa ei olisi.



Varmista, että laitteen ja seinän tai toisen laitteen välissä on vähintään 500 mm, jotta asiakkaat eivät loukkaannu laitteen liikkumisesta johtuen.



Varmista, että virtalähteen jännite on 230 V AC, jotta ei laite vioitu.

Huomio: Jos tämä laite sijoitetaan liukkaalle esim. vahatulle lattialle, suositellaan laitettavaksi kumityynytt säätöjalkoihin liikkumisen estämiseksi.

Huomio: Varmista, että takaosan taakse jää vähintään 500 mm tilaa, jotta virtalähteeseen ja CPU-korttiin pääsee käsiksi.

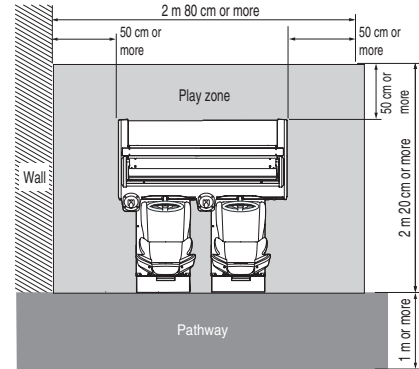

Laite on varustettu kääntyvillä pyörillä. Tämä on pidettävä mielessä, kun laitetta siirretään kaltevalle alustalle.



Yläosan painopiste on yläosan etuosassa. Tästä syystä on yläosaa asennettaessa tai poistettaessa oltava vähintään kaksi henkilöä.



Yläosan asennusasento on erittäin korkealla. On tärkeää, että tarvittavalle korkeudelle päästään vaivattomasti ilman venyttämistä. (esim. käytä tukevia tuoleja tai tikkaita)



Laitteen kokonaiskorkeus on yli 2050mm. Varmista, ettei katossa ole esteitä. esim. valaisimia.



Vain riittävän ammattipätevyuden omaava henkilö saa suorittaa asennus-, huolto-, säätö- tai muita laitteeseen kohdistuvia rutiinitoimenpiteitä.



Tälle laitteelle ei saa tehdä mitään hyväksymättömiä muutoksia. Se voi aiheuttaa ennalta-arvaamattomia vaaroja.



Vain Namco Europe Ltd:n määrittelemiä varaosia saa käyttää vaihtaessasi tai korjatessasi osia. (sisältäen ruuvit).



Varmista, että laite on kytketty POIS PÄÄLTÄ ennen työn aloittamista.



Ota yhteyttä maahantuojaan ohjeita varten, jos joudut tekemään työtehtäviä, joita ei ole esitelty huoltokirjassa, muuten vastuuta vioista tai loukkaantumisista ei ole.



Virtalähde ja monitori pysyvät kuumina ja niissä on alueita, joissa on korkeajännite vaikka laite on kytketty pois päältä. Palovammojen tai sähköiskun saaminen on mahdollista. Älä koske näihin laitteisiin.



Varmista, että laite on kytketty POIS PÄÄLTÄ ennen johtojen kytkemistä tai irrottamista.



Irrottaessasi verkkojohdon seinästä tai laitteesta, ota kiinni itse pistokkeesta, ei johdosta.

1. SPECIFICATIONS

POWER SUPPLY:-	230v / 500watts AC
AMBIENT OPERATING TEMPERATURE	+5°C to +25°C
MONITOR:-	Pantronic 29" Flat Screen w/o Remote
COIN ACCEPTOR:-	Mars 340 CashFlow - 4 Channel Dispense
DIMENSIONS:-	
Assembled	1760(w) x 1750(d) x 2050(h)
Monitor Cabinet	1760(w) x 860(d) x 1590(h)
Seat Assembly (ea)	445(w) x 890(d) x 1250(h)
Header Assembly	1300(w) x 310(d) x 460(h)
WEIGHT:-	
Assembled	495kg
Monitor Cabinet	369kg
Seat Assembly	53kg (ea)
Header Assembly	20kg
ACCESSORIES:-	
	Keys: (Cash Door) 2
	(Coin Door) 2
	(Back Door) 2
	IEC Mains Lead 1
	Operators Manual 1
	Monitor Manual 1
	CashFlow Documents 1
	M5 Security Wrench 1
	Potentiometer (Pedal 1kΩ 40°) .. 1
	Potentiometer (Steering 5kΩ)..... 1

2. MAIN COMPONENTS

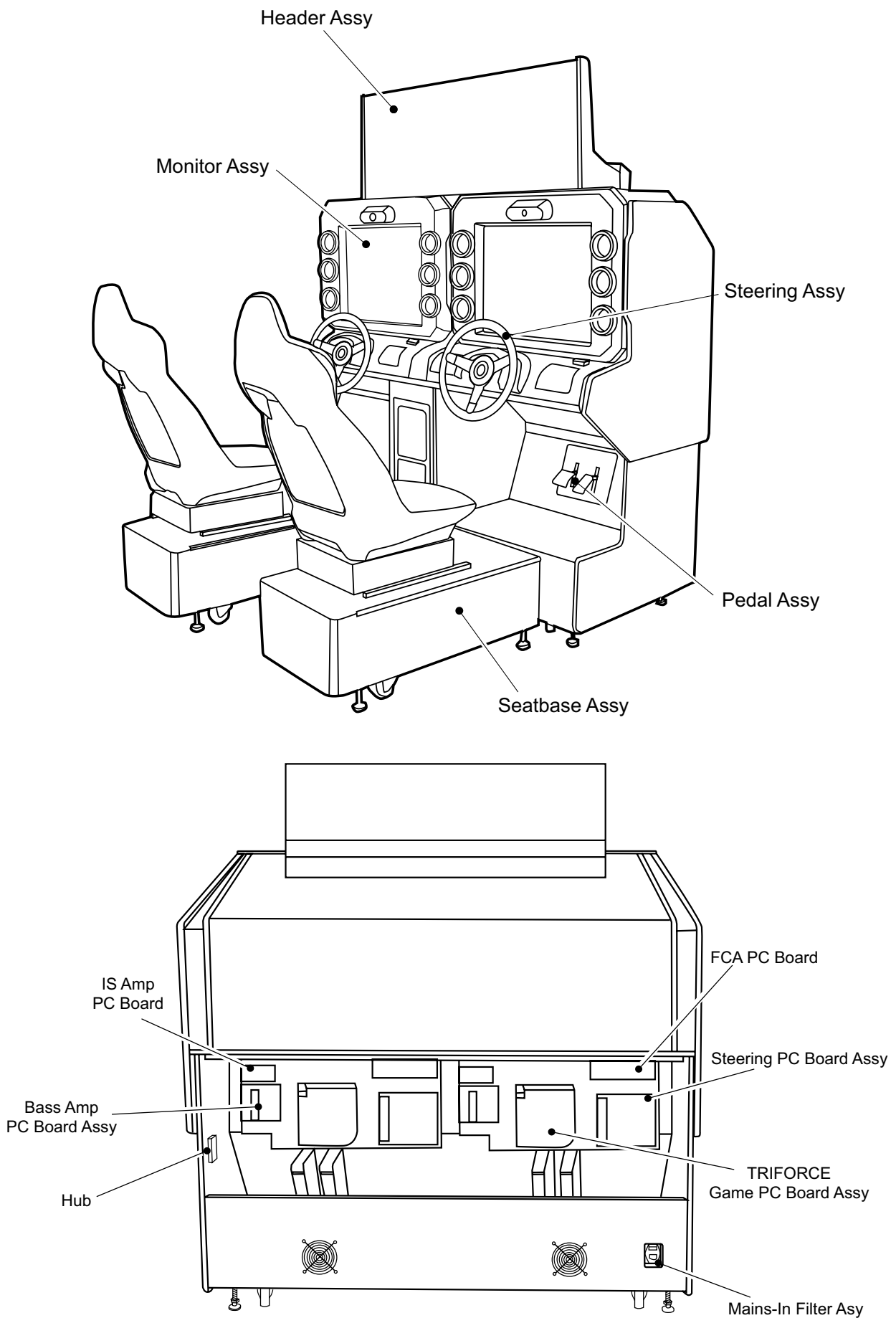

3 HOW TO PLAY



- If people are conducting the following actions, warn them of potential danger.
 - Two people are in the seat and playing the game.
 - A person other than the player is operating the steering wheel.
 - A person is touching the seat rail or slide section.



- If a player becomes sick due to game images or stimulation by lights, have the person stop playing the game immediately and let him/her rest.



- In rare cases, stimulation by lights or video images can cause convulsions or a loss of consciousness. If this happens, advise the person to see a doctor for medical examination as soon as possible. When pre-school children play, request their parents or guardians to observe the children.

This action racing game machine allows communication-linked Versus Race game play when two to four units are connected.

In the game, a player operates the kart driven by a game character and participates in a race. A player uses a pre-selected item to obstruct rivals in order to win the race. When a player wins a game, he/she gets a new item.

The ultimate purpose of the game is to collect many useful items by winning races and continue winning by using collected items.

General description of the game

• About game modes

- Versus Race mode: In this mode, the player competes with other players in a communication-linked game. Up to four players can play in this mode. A winning player obtains an item.
- Grand Prix mode: This is a single-player mode. The player competes in each of the six Cup races in order. Each time the player wins, he/she obtains an item.
- Time Attack mode: This is a single-player mode. The player races against time on a course with no rival karts.

• Versus Race mode

- When a player inserts the required number of coins, the screen displays a message "Please wait!" At this point, the player's entry in a Versus Race is registered. The other communicating units display "Waiting for entry!" and wait for players to join. When the Versus Race game is entered by one or more players, the game starts in the Versus Race mode.
- When all participating players select their characters, the namcam2 (camera) captures the facial images of players and displays them on their respective screens.
- After images are captured, the machine units display the "Select Stage" screen. After all players enter their choices, a stage is decided by a majority vote. (If the number of votes is the same between two stages, the easier stage is selected.)

Then, the machines display the “Select Course” screen. A course is selected in the same way as the stage. There are six stages and four courses for the Versus Race game.

- After a course is selected, three items are selected by the slot drawing.
 - When items are selected by all players, the race starts. The purpose of the game is to win the race by using the three selected items skillfully.
 - The winner receives a new item as a prize and the game ends.
-
- **Grand Prix mode**
 - When no other players join while the message “Please wait!” is shown on the screen or when the entry to the Versus Race game is cancelled, the machine enters a single-player game mode. Then, the namcam2 captures the facial image of the player.
 - After an image is captured, the screen displays a message “Select game mode.” If the player chooses “Grand Prix,” the game starts in the Grand Prix mode.
 - When the screen displays a message “Which Cup will you challenge?”, the player enters a choice. When the screen displays “Which Round will you challenge?”, the player enters a choice. There are six Cup races in the Grand Prix mode. Each Cup race consists of four rounds and one Challenge game. After a player clears Round 4, he/she can play a Challenge game. When the player wins the Challenge game, the player earns the Cup championship. In the initial game, a player can select only Round 1 of five Cup races. The sixth Cup race can be selected only when the player wins all other five Cup races.
 - In the Grand Prix mode, a player uses three preset items in the race.
 - When items to be used are determined, the race starts. The purpose of the game is to cross the finish line ahead of all others by using the three selected items skillfully. When a player wins a race and clears a Round, he/she obtains a new item.
 - When a player clears a Round, the screen displays “Do you want to challenge next round?” If the player chooses “YES” and inserts coins required for a Continue play, a race starts in the next round. If the player cannot clear this round, the screen displays “Continue?” When “YES” is selected and the required number of coins are inserted, a race starts in the same round.
 - When a player chooses “NO,” the game ends. • When a player wins all six Cup races, an ending scene is shown on the screen.
-
- **Time Attack mode**
 - If a player chooses “Time Attack” on the “Select game mode” screen, a game starts in the Time Attack mode.
 - When a course to be played is determined, the race starts. The purpose of the game in the Time Attack mode is to go around the course a specified number of times in the shortest time possible. A player can use three Dash Mushroom items.

- If the player ranks within the top ten positions after the Time Attack game, a ranking chart is displayed and the player's name is recorded on the ranking table.
- After the Time Attack game, the screen displays "Continue?" When "YES" is selected, the player selects a course again and plays a new game in the Time Attack mode.

4. MOVING THE MACHINE

This equipment is fitted with castors to make it easier to move. Take care when moving the equipment on an inclined floor.

The overall height of this equipment is 2050mm. Take care of any overhead obstructions. (e.g. Light Fittings, Electric Cables etc.)

Before moving, ensure that the game is separated into 4 parts: Header Assy, Monitor Cabinet and Seat Assemblies

5. INSTALLATION

Notes on Installation



NEVER turn the power to the machine ON until installation has been completed



In order to prevent possible electric shocks, be sure that the machine is connected to the mains supply with a securely connected earthed plug.



So that customers are not injured, ensure that there is at least 500mm separation between other machines or walls.



In order to avoid damage to the machine due to mis-operation, ensure that the voltage of the mains supply is 230volts AC.

- NOTE
- If the location site of this machine has a polished floor, it is recommended that rubber pads are fitted under the level adjusters to prevent the machine sliding on the floor.
 - In order to gain access to the Power Supply and CPU assemblies, ensure that the rear of the machine is separated from a wall or other machine by at least 500mm



GB

**This machine is designed for INDOOR USE ONLY.
Do not install in the following places.**

1. **Outdoors**
2. **Direct Sunlight, places with excessive humidity or dust, places where there is water leakage, near air-conditioning or heating equipment, places with excessive heat or cold temperature.**
3. **Places where it would be in the way of emergency exits or fire extinguishing equipment.**
4. **Unstable places or places with excessive vibration.**
5. **Places that are not level.**
6. **This machine must not be cleaned with a water jet, or installed in an area where a water jet could be used.**

D

**DIESES GERÄT IST NUR FÜR DIE GEWERBLICHE AUFSTELLUNG IN
GESCHLOSSENEN RÄUMEN BESTIMMT. DAS GERÄT DARF AN FOLGENDEN
PLÄTZEN NICHT AUFGESTELLT WERDEN**

1. **Im Freien.**
2. **In direktem Sonnenschein, an extrem feuchten und staubigen Plätzen, an Plätzen mit Wasseranschlüssen und möglichen Leckagen, nahe Klima- und Heizungsanlagen, an Plätzen mit extrem hohen oder niedrigen Temperaturen.**
3. **In der Nähe von Notausgängen oder Feuerlöschgeräten.**
4. **An unstablen Plätzen oder Plätzen mit übermäßiger Vibration.**
5. **An Plätzen, die nicht eben sind.**
6. **Diese Maschine darf nicht mit einem Wasserstrahl gereinigt oder in einem Bereich installiert werden, in dem Wasserstrahlen verwendet werden.**

DK

**DENNE MASKINE ER KUN DESIGNET TIL INDENDØRSBRUG
INSTALLER IKKE MASKINEN PÅ FØLGENDE STEDER**

1. **Udendørs**
2. **Direkte sollys, steder med høj fugtighed el. støv, steder med vand udslip, i nærheden af air-condition eller varme udstyr, steder med usædvanlig høj el. kold temperatur.**
3. **Steder hvor den vil stå i vejen for nødudgange eller brandslukningsudstyr.**
4. **Ustabile steder eller steder med for store vibrationer.**
5. **Steder der ikke er plane.**
6. **Maskinen må ikke renses med en vandstråle eller monteres et sted hvor det er muligt at bruge en vandstråle.**

E

**ESTA MÁQUINA ESTA DISEÑADA ÚNICAMENTE PARA USO EN INTERIORES. NO
INSTALE LA MÁQUINA EN LOS SIGUIENTES LUGARES.**

1. **Exteriores.**
2. **Bajo luz solar directa, en lugares con polvo o humedad excesiva, lugares donde hay filtraciones de agua, cerca de aparatos de calefacción o de aire acondicionado, lugares con temperatura ambiente muy alta o muy baja.**
3. **Lugares donde la máquina obstruya salidas de emergencia o equipos de extinción de incendios.**
4. **Suelos inestables o lugares con vibraciones excesivas.**
5. **Lugares con suelos no nivelados.**
6. **Esta máquina no deberá ser lavada con agua a presión. Tampoco deberá instalarse en áreas donde puedan haber chorros de agua.**

F

**CETTE MACHINE EST DESTINEE UNIQUEMENT A UN USAGE INTERIEUR
NE PAS INSTALLER LA MACHINE DANS LES ENDROITS SUIVANTS**

1. A l'extérieur.
2. Directement exposée au soleil, aux endroits excessivement humides ou poussiéreux, aux endroits où il y a des risques de fuite d'eau, près de ventilateurs ou source de chaleur, aux endroits très chauds ou froids.
3. Dans des zones de proximité des sorties de secours ou d'accès aux équipements d'extinction du feu.
4. Dans des emplacements instables ou soumis à de fortes vibrations.
5. Dans des endroits dénivelés.
6. Ne nettoyez pas cette machine sous un jet d'eau et ne l'installez pas à un endroit où l'on risque d'employer des jets d'eau.

GR

**ΤΟ ΜΗΧΑΝΗΜΑ ΕΙΝΑΙ ΣΧΕΔΙΑΣΜΕΝΟ ΓΙΑ ΧΡΗΣΗ ΣΕ ΕΣΩΤΕΡΙΚΟ ΧΩΡΟ ΜΟΝΟ
ΜΗΝ ΤΟΠΟΘΕΤΗΣΕΤΕ ΤΟ ΜΗΧΑΝΗΜΑ ΣΤΟΥΣ ΑΚΟΛΟΥΘΟΥΣ ΧΩΡΟΥΣ**

1. Εξωτερικά
2. Απευθείας στον ήλιο, σε μέρη όπου υπάρχει υγρασία ή σκόνη, μέρη όπου υπάρχει άφθονο νερό, κοντά σε air-condition ή άλλου είδους θέρμανση, μέρη με υπερβολική υψηλή ή χαμηλή θερμοκρασία.
3. Σε μέρη όπου εμποδίζουν μέσα ανάγκης π.χ. πυροσβεστήρες ή άλλα.
4. Μη σταθερά μέρη ή μέρη με πολλούς κραδασμούς.
5. Μέρη που δεν είναι επίπεδα.

I

**QUESTA MACCHINA E' PROGETTATA PER ESSERE USATA ESCLUSIVAMENTE IN
AMBIENTI INTERNI. NON INSTALLARE LA MACCHINA NEI SEGUENTI LUOGHI.**

1. In ambienti esterni.
2. Alla luce diretta del sole, in posti con eccessiva umidità o polvere, in luoghi dove ci siano infiltrazioni d'acqua, vicino ad apparecchi di condizionamento d'aria oppure riscaldamento, in posti eccessivamente caldi o freddi.
3. In luoghi dove potrebbe esserci un'uscita di emergenza o un'attrezzatura per lo spegnimento del fuoco.
4. In posti non stabili o con eccessive vibrazioni.
5. In luoghi non piani.
6. La macchina non deve essere pulita con un getto d'acqua, né installata in un'area in cui si utilizza un getto d'acqua.

N

**DENNE MASKINEN ER BARE KONSTRUERT FOR INNENDØRS BRUK
IKKE INSTALLER MASKINEN PÅ FØLGENDE Plasser.**

1. Utendørs
2. Konstant sollys, plasser med mye fuktighet og støv, plasser hvor det er vannlekasje, nære luft kjølere eller varme elementer, plasser med overdreven høy eller lav temperatur.
3. Plasser hvor det vill stå i veien for nødutganger eller brannslukking utstyr.
4. Ustabile plasser eller plasser med overdreven vibrasjon.
5. Plasser som ikke er i vater.
6. La macchina non deve essere pulita con un getto d'acqua, né installata in un'area in cui si utilizza un getto d'acqua.



**DEZE MACHINE IS ALLEEN VOOR GEBRUIK BINNENSHUIS ONTWERPEN
INSTALLLEER DE MACHINE NIET OP DE VOLGENDE PLAATSEN**

1. Buiten
2. In direct zonlicht, op plaatsen met een zeer hoge vochtigheidsgraad of met veel stof, op plaatsen waar een waterlek is, dichtbij airco's of verwarmingsapparatuur, op plaatsen met een zeer hoge of koude temperatuur.
3. Op plaatsen waar nooduitgangen of blusapparatuur worden geblokkeerd.
4. Op onstabiele plaatsen of plaatsen waar grote trillingen voorkomen.
5. Op plaatsen die niet vlak zijn.
6. Deze machine mag niet gereinigd worden met een waterstraal of geïnstalleerd worden op een plaats waar een waterstraal gebruikt kan worden.



**ESTA MAQUINA FOI CONCEBIDA PARA UTILIZAÇÃO EM ESPACOS
INTERIORES APENAS NÃO INSTALAR A MAQUINAS NOS SEGUINTE LOCAIS:-**

1. Exteriores.
2. Luz solar directa, locais com humidade excessiva ou pó, locais aonde existam fugas de água perto de ar condicionados ou equipamentos caloríficos e locais com temperaturas excessivamente quentes ou frias.
3. Locais aonde ficaria colocada no caminho de saidas de emergência ou equipamentos extintores de fogo.
4. Locais estruturalmente instáveis ou locais com vibrações excessivas.
5. Locais não nivelados.
6. Esta máquina não deve ser limpa com jato de água, ou instalada em área na qual possam ser usados jatos de água.



**DENNA MASKIN ÄR AVSEDD ENBART FÖR INOMHUSBRUK
INSTALLERA EJ MASKINEN PÅ FÖLJANDE STÄLLEN**

1. Utomhus
2. I direkt solsken, platser med extremt hög luftfuktighet eller damm, platser där det förekommer vattenläckage, nära luftkonditionering eller värmeelement, i extremt hög eller låg temperatur.
3. Platser där den skulle kunna vara i vägen för nödutgångar och brandsläckningsutrustning.
4. Instabila ställen eller där stark vibration förekommer.
5. Platser med nivåskillnad.
6. Denna maskin får inte rengöras med en vatten stråle, eller monterad inom ett område där en vatten stråle kan användas.



**TÄMÄ LAITE ON SUUNNITELTU VAIN SISÄKÄYTTÖÖN
ÄLÄ ASENNA LAITETTA SEURAAVIIN PAIKKOIHIN:**

1. Ulkotilaan
2. Suoraan aurinkovaloon, kosteisiin tai pölyisiin paikkoihin, vesivuotopaikkojen läheisyyteen, ilmanvaihto- tai lämmityslaitteen lähistölle tai paikkoihin, jossa on erittäin kuumaa tai kylmää.
3. Varauloskäytävien, muiden pakoteiden tai tulensammutusvälineiden eteen.
4. Epävakaisiin tai täriseviin paikkoihin.
5. Kaltevalle alustalle.
6. Tätä laitetta ei saa pestä suihkuttamalla sille vettä eikä sijoittaa sellaiseen paikkaan, missä se voi joutua alttiiksi vesisuihkuille.

5-1 Removing the Header Assy

 **The fitting position of the Header Assembly is high, and it is important that a means of reaching the height safely, without stretching, is available. (e.g. Steps, Step Stool etc.)**

1. Remove 6 off pozi head screws (3 each side).
2. Lift the header assembly sufficient to reach the connector.
3. Disconnect the connector and remove the Header assembly.

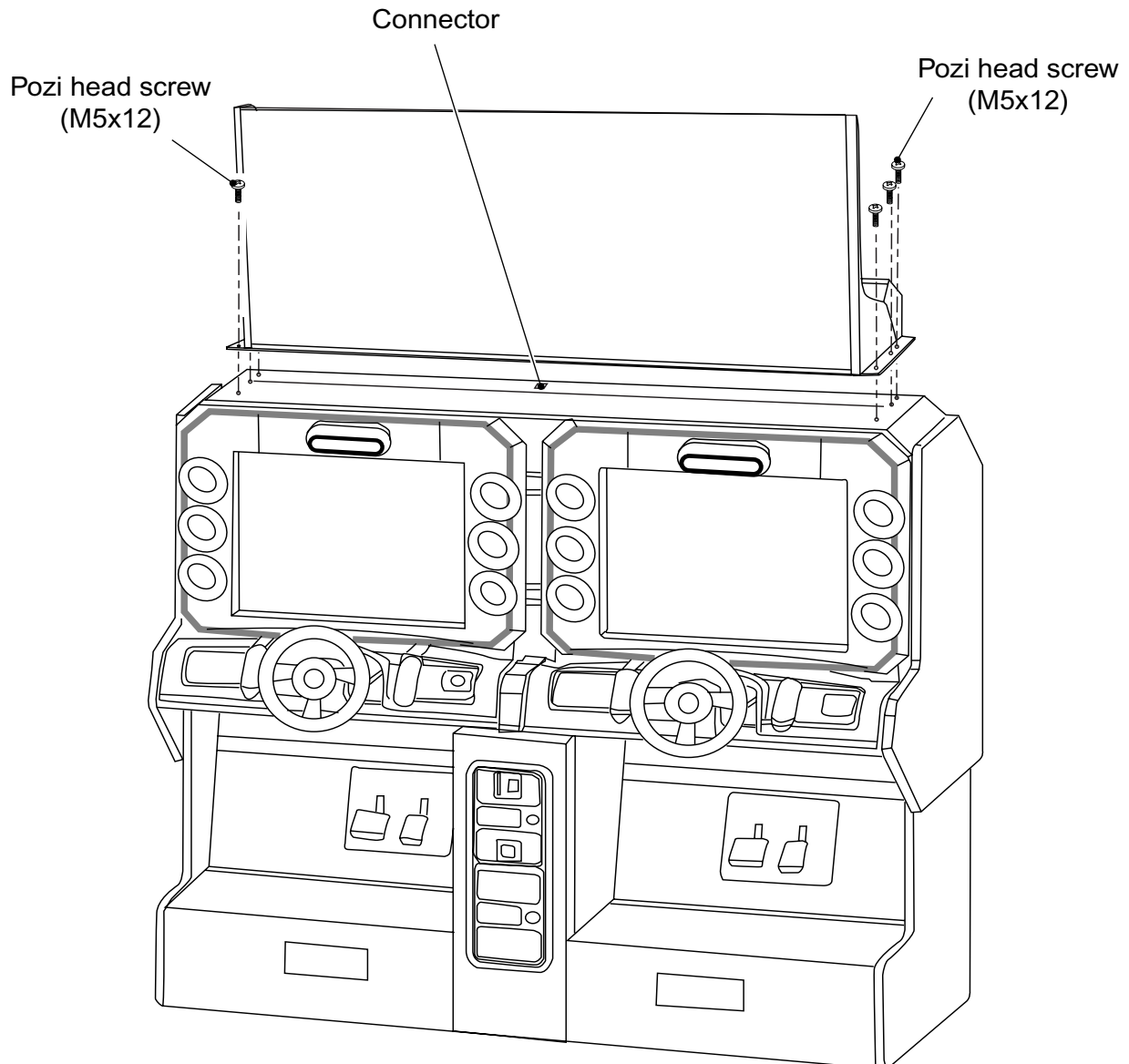

4. Reassemble in reverse order.

5-2 Fitting the Seat Base Assemblies.

1. Place the Seatbase assembly close to the Monitor Cabinet and connect the connector.
2. Place the Seatbase assembly between the Seat Brackets, taking care not to trap any wires.
3. Fit 6 off (3 each side) socket button head screws (M8x16), with flat and spring washers.
4. Repeat for each Seatbase assembly.

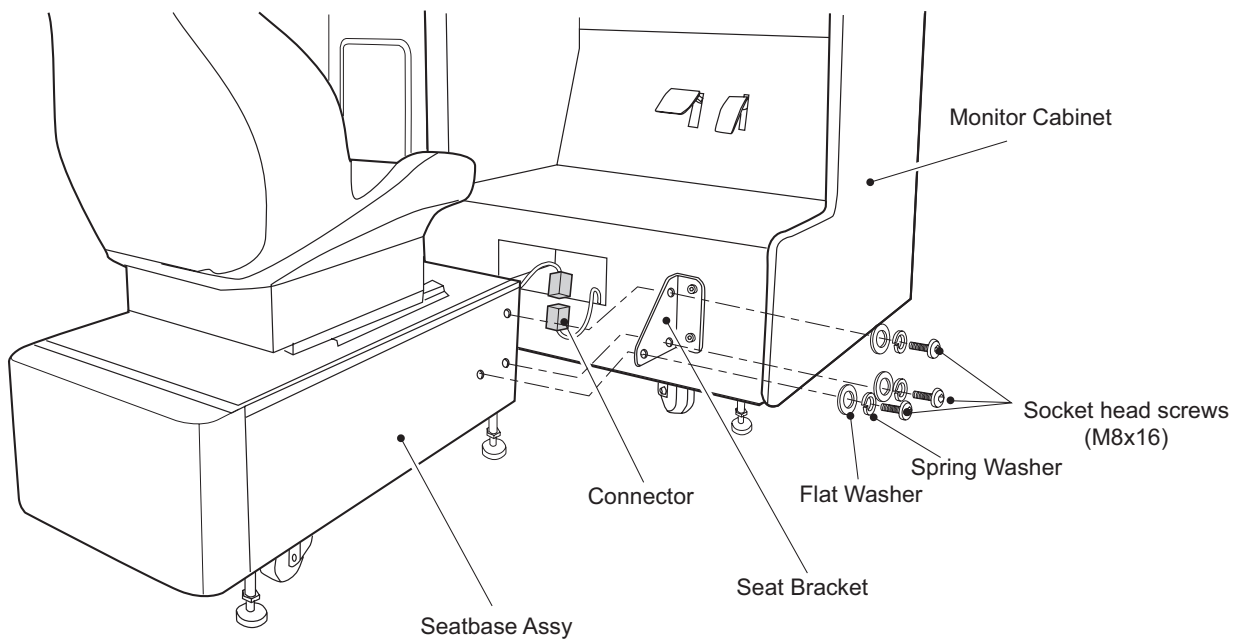

5-3 Linking Two Cabinets

1. Remove the rear doors from both cabinets.
2. Connect the Link Cable to the spare position in each Hub.
3. Enter Test Mode, Game Options (6-2-4-1), and ensure that the Game PCB ID is set as follows:
ID 1 for the Left Player on the Left Cabinet
ID 2 for the Right Player on the Left Cabinet
ID 3 for the Left Player on the Right Cabinet
ID 4 for the Right Player on the Right Cabinet.
4. Refit the rear doors.

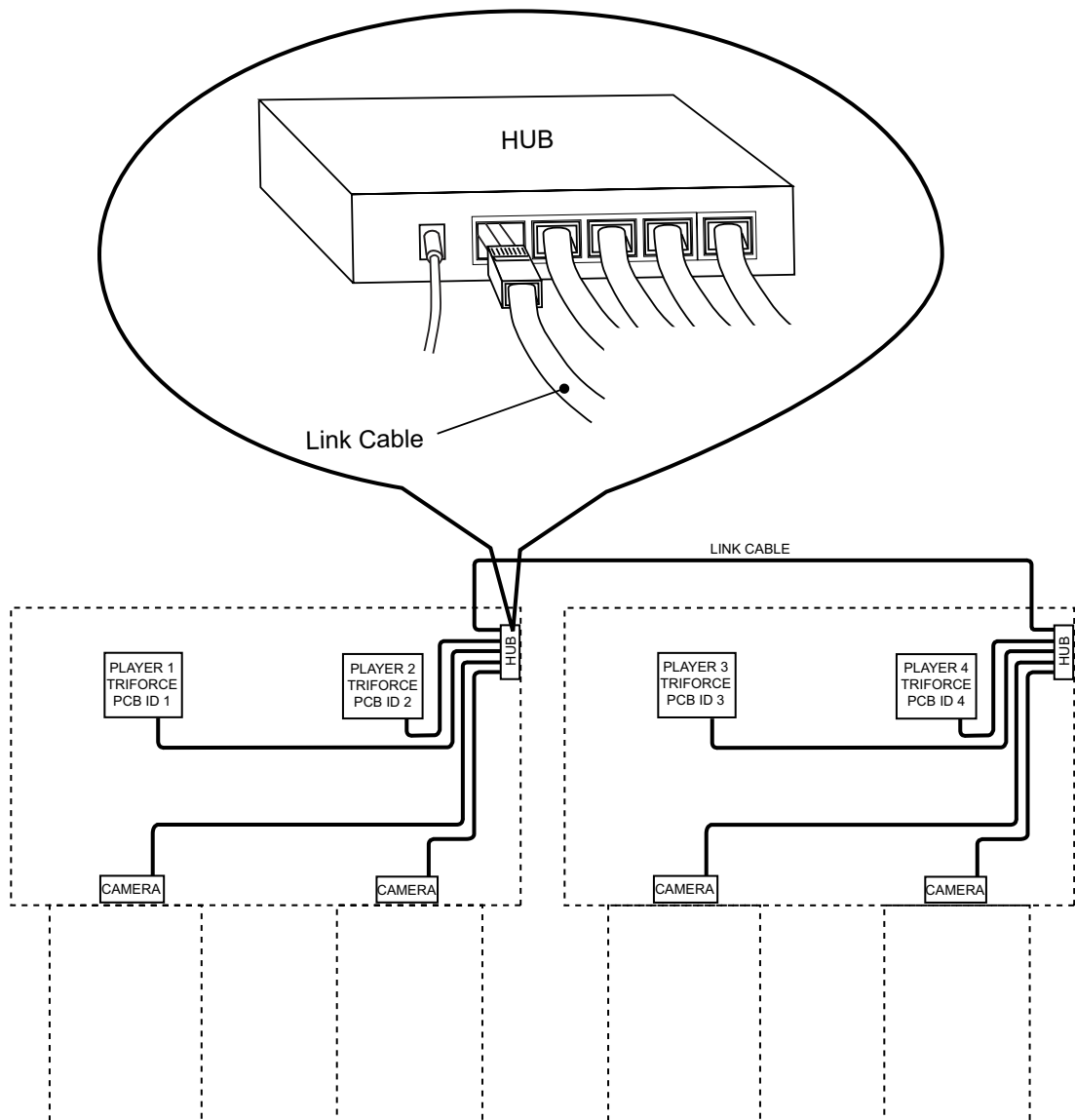

5-4 Game Initialization

- Be sure to perform the following initialization process before the game is played for the first time, and after replacing the Game PC Board, Steering Assy Potentiometer, Accelerator/Brake pedal potentiometers, or after initializing the backup data. The game will not play properly without executing the initialization.
 - After initializing potentiometers, conduct a switch test ([see 6-2-4-2\(b\) page 50](#)) to ensure that “OK” is shown when the steering wheel, accelerator pedal or, or brake pedal are operated.
1. While pressing the Service button, press the Test switch. The following screen is displayed.

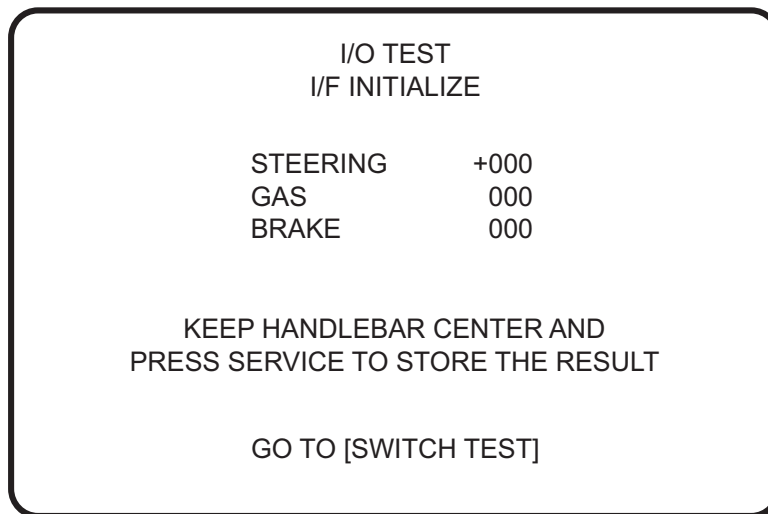

2. Ensure that the steering wheel is in the centre position. Remove your hands from the steering wheel, and ensure that your feet are removed from the accelerator and brake pedals. (Initialization will not be completed correctly if the steering wheel or accelerator/brake pedal is operated).
3. With the steering wheel and pedals as described above, press the Service switch. The potentiometers will be initialized.
4. After the initialization, the screen for the switch test ([see 6-2-4-2\(b\) page 50](#)) appears. Turn the steering wheel fully to the right and then to the left, and make sure that “RIGHT OK” and “LEFT OK” is displayed on the screen.
5. Fully depress the accelerator and brake pedals, and make sure that “OK” is displayed for both pedals.
6. Press and hold the Service switch, and press the Test switch to return to the I/O test screen.

5-5 Adjusting the Level Adjuster

1. When the game is in its final position, lower the twelve (12) Level adjusters (4 off Monitor Cabinet and 4 off each Seat Base Assy), with a spanner, so that all castors are raised from the floor by approximately 5mm. Tighten the lock nuts with a spanner to ensure that the Level Adjusters do not move.

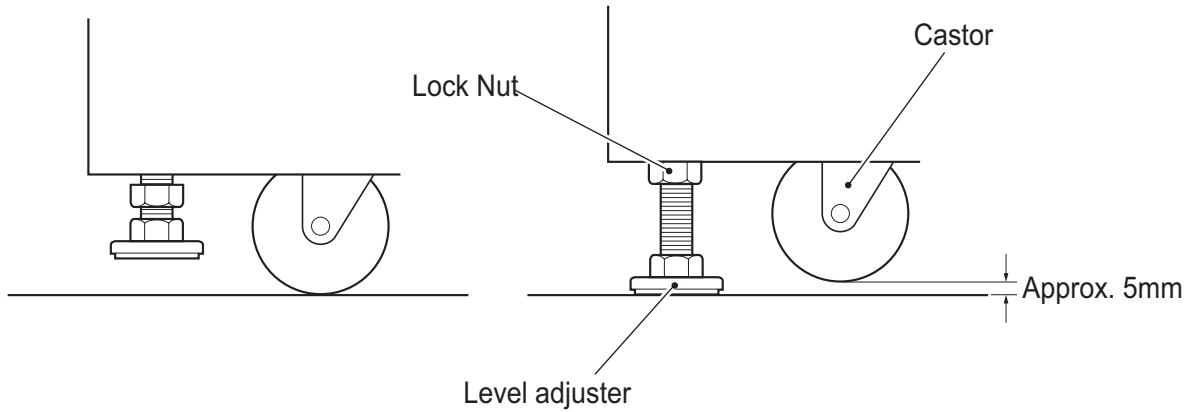

Note: If the site of this game has a smooth or polished floor, it is recommended that rubber pads are fitted under the Level Adjusters to prevent the game sliding on the floor when in use.

6. ADJUSTMENTS



- GB** Adjustment or maintenance on this machine should be carried out by qualified personnel only.
- D** Einstellungen und Wartung des Gerätes dürfen nur von dafür qualifiziertem Fachpersonal vorgenommen werden.
- DK** Justeringer eller vedligehold af denne maskine bør kun udføres af kvalificeret personale.
- E** Los ajustes y el mantenimiento de esta máquina deben ser realizados sólo por personal cualificado.
- F** L'installation, le service, le réglage, ou la maintenance doivent être effectués uniquement par les personnes qualifiées.
- GR** Μετατροπές ή επιδιορθώσεις στα μηχανήματα πρέπει να γίνονται μόνο από εξουσιοδοτημένα άτομα.
- I** Regolazioni e manutenzione su questa macchina devono essere fatti solo da personale specializzato.
- N** Justering eller vedlikehold på denne maskinen skall bare utføres av kvalifiserte personell.
- NL** Aanpassingen of onderhoud aan deze machine dient alleen uitgevoerd te worden door bekwaam personeel.
- P** Afinações ou manutenção nesta máquina, deverão ser efectuadas sómente por pessoal qualificado.
- S** Justeringar och underhåll på denna maskin skall endast utföras av kvalificerad personal.
- SF** Tätä laitetta saa säätää tai huoltaa vain siihen ammattipätevyyden omaava henkilökunta.

6-1 Adjustment Switches

The Adjustment switches are located inside the coin door.

1. Service Switch.
Press this switch to obtain game credits without incrementing the play meter.
2. Test Switch
Press this switch to enter test mode.
Test mode allows testing and the changing of game settings. ([Refer to section 6-2 "Test Mode" page 44](#))
3. The Test and Service switches are used to select and alter data within the Test Mode

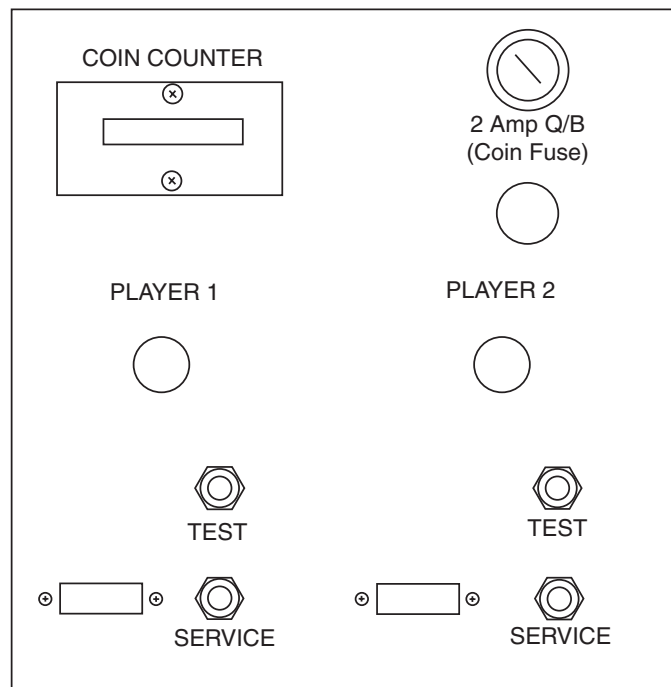

6-2 Test Mode

1. Open the coin door and press the respective test switch. The 'System Menu' screen will be displayed.
2. Press the Service button to step through the items available. The selected item is indicated by an arrow next to the item.
3. Press the Test button to enter the selected test.
4. Select 'EXIT' and press the Test button to return to the normal game mode.

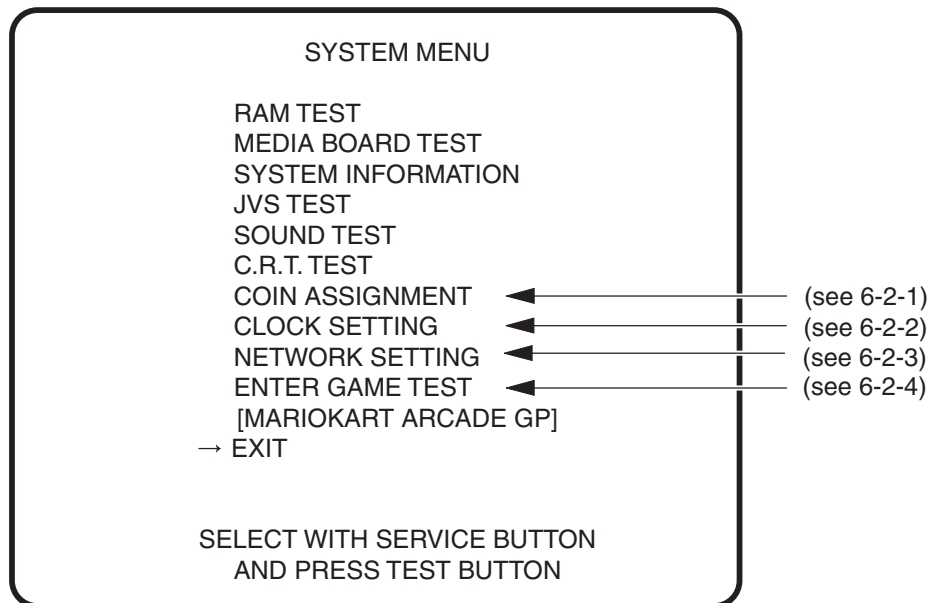

Note: Only 'COIN ASSIGNMENT' and ENTER GAME TEST' functions are used on this game.

- To prevent game malfunctions, do not change the setting of any item other than those described in the manual.
- Wait until the game being played on another linked position has ended. Starting the Test Mode in one game position may affect the game being played at other positions.
- When returning to game mode, be sure to complete the process for all positions within one minute; otherwise, the games may fail to communicate properly.
The communication status can be confirmed by checking the indication "Maximum of X units can be communicated" (X: indicates the number of units) in the upper left corner of the screen.

6-2-1 Coin Assignment

1. Select 'COIN ASSIGNMENT' on the 'System Menu' screen and press the test button to set the game cost and related settings. The following screen is displayed.

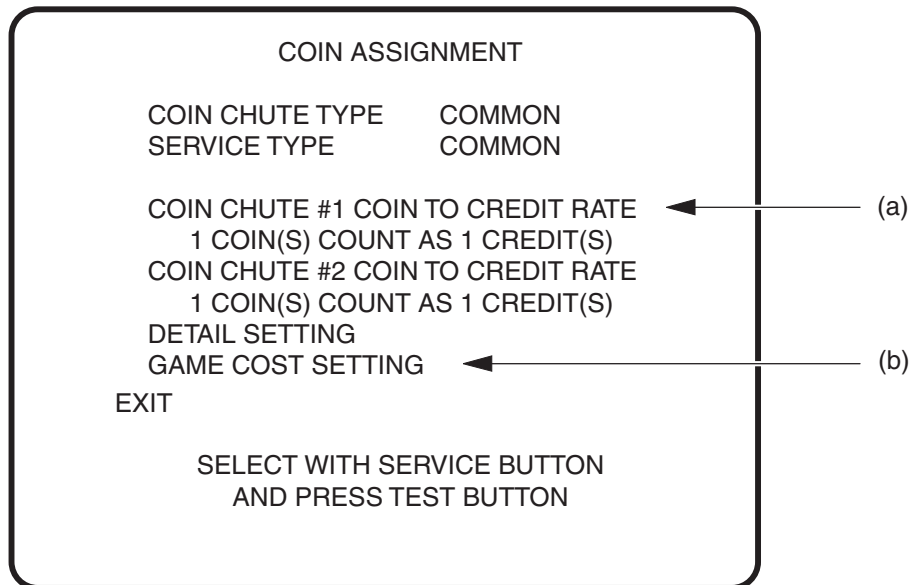

2. Press the Service button to select 'COIN CHUTE #1 TO CREDIT RATE' and press the Test button.
3. Press the Service button to change the value then press the Test button.

(a) COIN CHUTE #1 COIN TO CREDIT RATE

The following options are available

1 COIN(S) COUNT AS 1 CREDIT(S)
2 COIN(S) COUNT AS 1 CREDIT(S)
3 COIN(S) COUNT AS 1 CREDIT(S)
4 COIN(S) COUNT AS 1 CREDIT(S)
5 COIN(S) COUNT AS 1 CREDIT(S)
1 COIN(S) COUNT AS 2 CREDIT(S)
1 COIN(S) COUNT AS 3 CREDIT(S)
1 COIN(S) COUNT AS 4 CREDIT(S)
1 COIN(S) COUNT AS 5 CREDIT(S)
FREE PLAY

Note: *The price of play on this machine is set within the Cashflow Coin Mech. Ensure that Coin Chute #1 Coin to Credit Rate is set to 1 COIN(S) COUNT AS 1 CREDIT(S)*

4. Press the Service button to select 'GAME COST SETTING' and press the Test button, the following screen is displayed

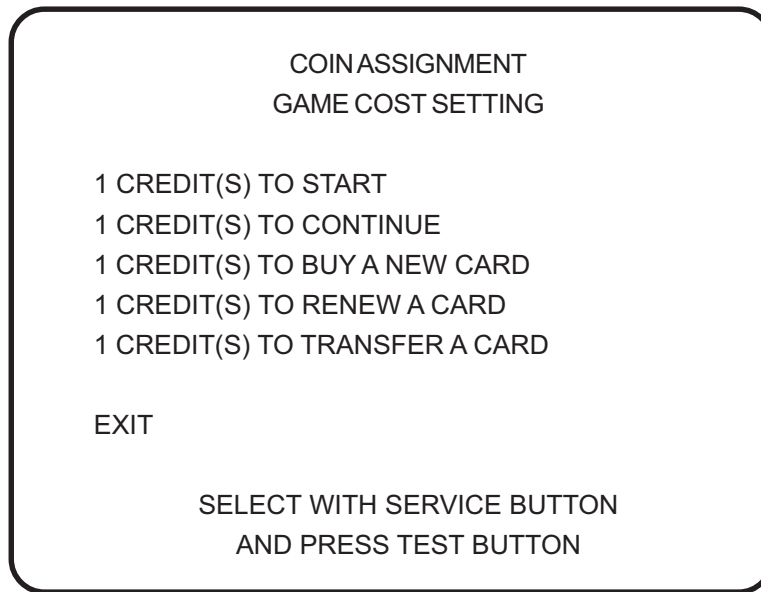

5. Press the Service button to select the required item then press the Test button.
5. Press the Service button to change the setting, then press the Test button.
6. Press the Service button to select 'EXIT' then press the Test button to return to the System Menu Screen.

Item	Factory Set	Description
1 CREDIT(S) TO START	1	Sets the number of credits required to start a game. Settable (1~9)
1 CREDIT(S) TO CONTINUE	1	Sets the number of credits required to continue a game. Settable (1~9)
1 CREDIT(S) TO BUY A NEW CARD	1	THIS ITEM IS NOT USED ON THIS GAME
1 CREDIT(S) TO RENEW A CARD	1	THIS ITEM IS NOT USED ON THIS GAME
1 CREDIT(S) TO TRANSFER A CARD	1	THIS ITEM IS NOT USED ON THIS GAME

(b) GAME COST SETTING

Note: *The price of play on this machine is set within the Cashflow Coin Mech. Ensure that CREDIT(S) TO START is set to 1*

6-2-2 Clock Setting

1. Select 'CLOCK SETTING' on the 'System Menu' screen and press the test button to set the Date and Time.
2. Use the Service and Test buttons to select and change the values.
3. Press the Service button to select 'EXIT' then press the Test button to return to the System Menu Screen.

6-2-3 Network Setting

1. Select 'NETWORK SETTING' on the 'System Menu' screen and press the test button to set the Network values.
2. Use the Service and Test buttons to select and change the values.

Ensure that the options are set to the following:

Network Type: ETHER
Set Up IP Address: DISABLE

3. Press the Service button to select 'EXIT' then press the Test button to return to the System Menu Screen.

6-2-4 Game Test Menu

1. Select 'ENTER GAME TEST' on the 'System Menu' screen and press the test button to enter the Game Test Mode. The following screen is displayed.

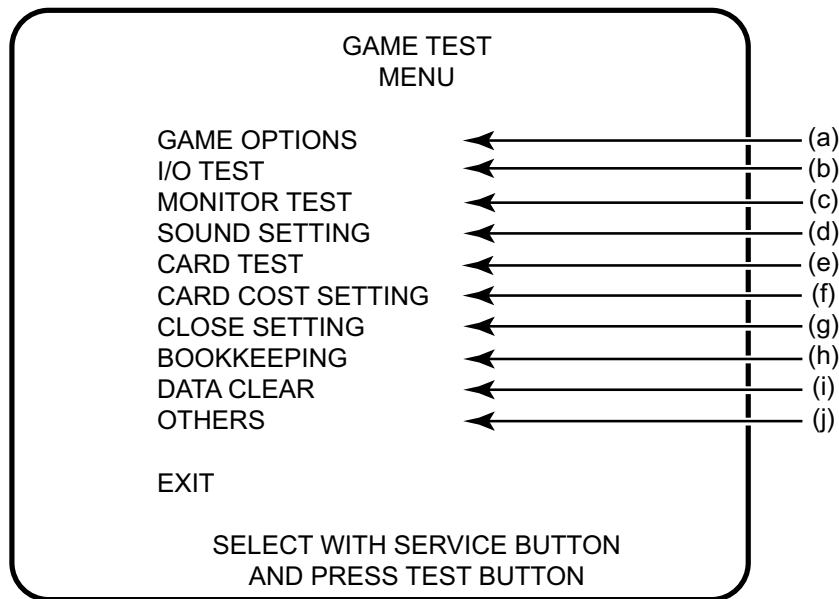

2. Press the Service button to select the required item then press the Test button.
3. Press the Service button to select 'EXIT' then press the Test button to return to the System Menu Screen.

- (a) Used to set the Game Options
- (b) Used to Initialize the game and to test switches and lamps.
- (c) Used to test and set-up the monitor.
- (d) Used to set the volume levels.
- (e) Not used on this game.
- (f) Not used on this game
- (g) Used to set the closing time of the site.
- (h) Displays bookkeeping data
- (i) Resets High Score or Bookkeeping data or resets to Factory Default.
- (j) Sets the on screen language and displays PCB version data.

6-2-4-1 Game Options

1. Select 'GAME OPTIONS' from the Game Test Menu. The following screen is displayed.

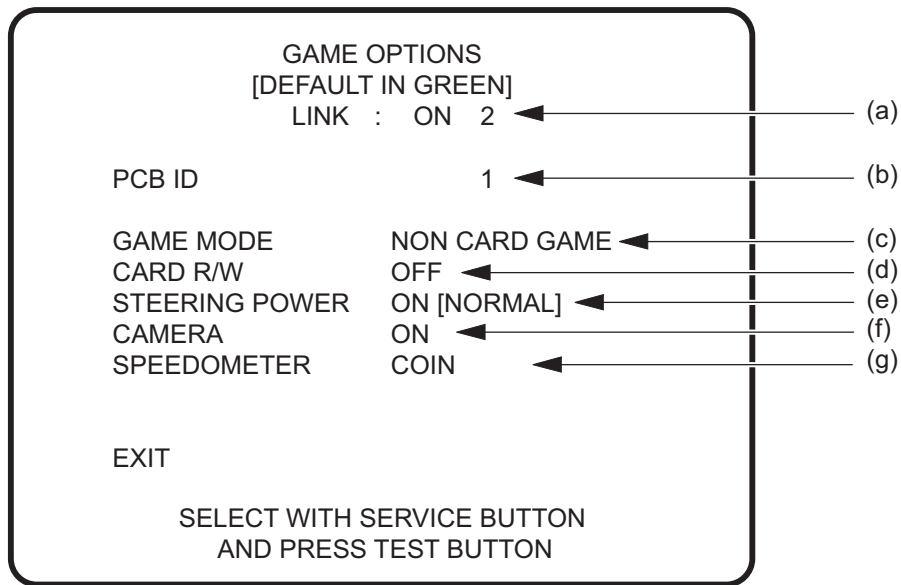

2. Press the Service button to select the required item then press the Test button.
3. Press the Service button to change the setting, then press the Test button.
4. Press the Service button to select 'EXIT' then press the Test button to return to the Game Test Menu Screen.

- (a) Link Condition LINK ON 4 : Four player positions are communicating properly.
 LINK ON 3 : Three player positions are communicating properly.
 LINK ON 2 : Communication in normal condition
 LINK OFF : Game is in standalone operation, or there is no communication with the other position.

Item	Description	Factory Set
(b) PCB ID	Displays the PCB ID setting Set PCB ID (b) to "1 thru 4" (When connecting two cabinets) in order of 1 as left hand player of left hand cabinet to 4 as right hand player of right hand cabinet.	1
(c) GAME MODE	CARD GAME NON CARD GAME	NON CARD GAME
(d) CARD R/W	Sets if a Card Reader/Writer is used ON: Read/Writer used OFF: Read/Writer not used	OFF
(e) STEERING POWER	ON [NORMAL]: Steering Feedback Motor ActivE ON [LIGHT]: OFF: Steering Feedback Motor Off	ON NORMAL
(f) CAMERA	ON: Camera Active OFF: Camera disabled	ON
(g) SPEEDOMETER	KM/H: Displays vehicle speed in km/h COIN: Displays vehicle speed in miles/h	COIN

6-2-4-2 I/O Test

1. Select 'I/O TEST' from the Game Test Menu. The following screen is displayed.

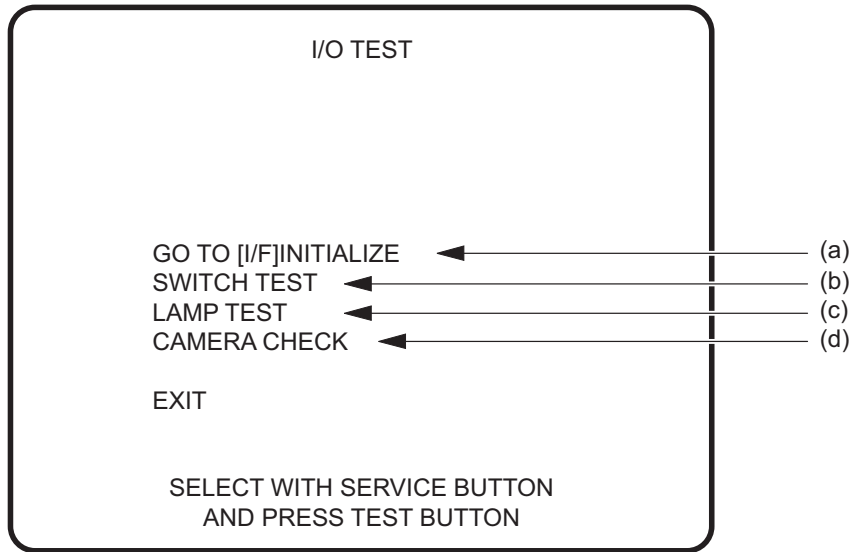

2. Press the Service button to select the required item then press the Test button.
3. Press the Service button to select 'EXIT' then press the Test button to return to the Game Test Menu Screen.

(a) GO TO [I/F] INITIALIZE

Note: *It is important that this test is selected following any changes or adjustments to the Steering, Brake or Accelerator assemblies. Failure to Initialize will result in incorrect operation of the game.*

1. Press the Service button to select GO TO [I/F] INITIALIZE and press the Test button. The following screen is displayed.

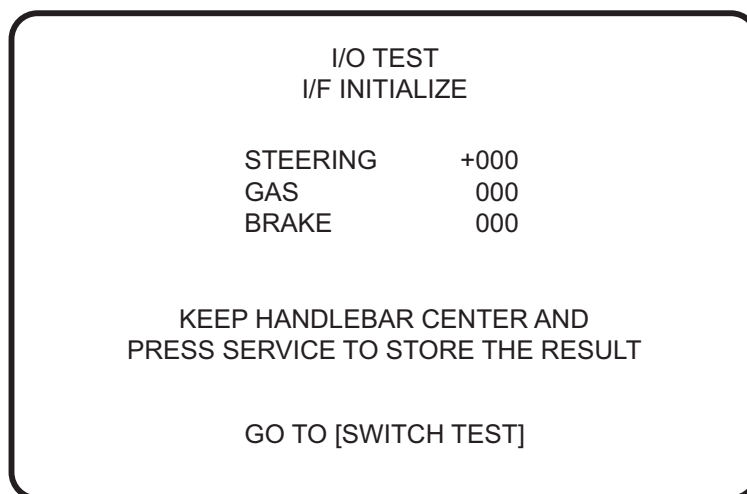

2. Ensure that the Steering Wheel is at the centre position, and the Accelerator and Brake pedals are fully up. Press the Service button. Initialization is completed automatically and the screen will change to the SWITCH TEST screen. (see (b) SWITCH TEST) on the next page.

(b) Switch Test

1. Press the Service button to select SWITCH TEST and press the Test button. The following screen is displayed.

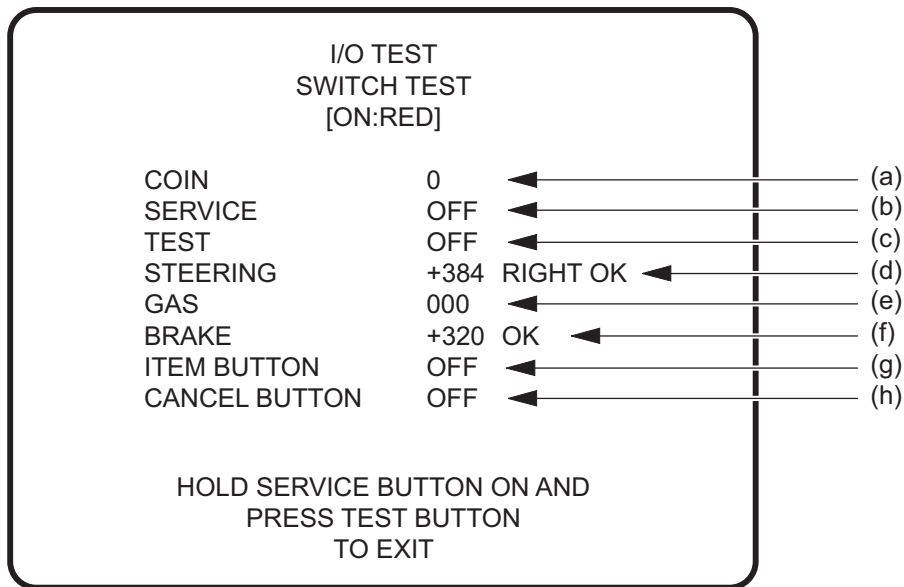

2. Press the Service and Test button together to return to the I/O Test Menu Screen.

(a) COIN	The number will increase for each credit signal received by the PCB
(b) SERVICE	Display changes from OFF to ON each time the switch is operated
(c) TEST	Display changes from OFF to ON each time the switch is operated
(d) STEERING	Numbers increase when the wheel is turned to the right or decrease as wheel is turned to the left. [LEFT or RIGHT OK] is displayed when the wheel is at full turn.)*Note
(e) GAS	Numbers increase as Accelerator is depressed. OK is displayed when pedal is fully depressed. *Note
(f) BRAKE	Numbers increase as Brake is depressed. OK is displayed when pedal is fully depressed. *Note
(g) ITEM BUTTON	Display changes from OFF to ON each time the switch is operated
(h) CANCEL BUTTON	Display changes from OFF to ON each time the switch is operated

Note: If "OK" is not displayed when the steering wheel is turned or a pedal fully depressed, it is necessary to initialize the steering and pedals.
(see 6-2-4-2(a) page 49)

(c) Lamp Test

1. Press the Service button to select LAMP TEST and press the Test button. The following screen is displayed.

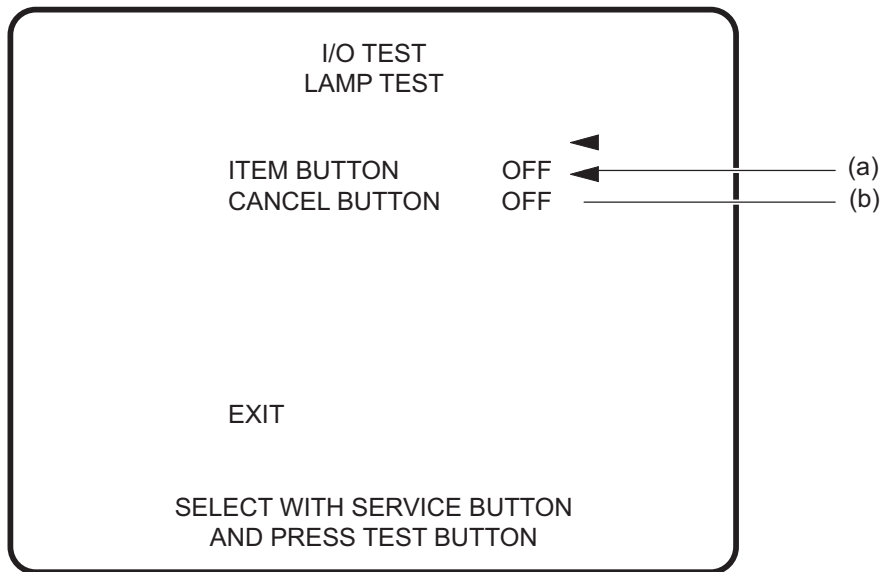

2. Press the Service button to select the required item then press the Test button.
3. Press the Service button to select 'EXIT' then press the Test button to return to the I/O Test Menu Screen.

- (a) ITEM BUTTON : Display changes from OFF to ON and the button lamp lights when the Test button is pressed.
- (b) CANCEL BUTTON : Display changes from OFF to ON and the Versus Race Cancel button lamp lights when the Test button is pressed.

(d) **Camera Check**

1. Press the Service button to select CAMERA CHECK and press the Test button. The following screen is displayed.

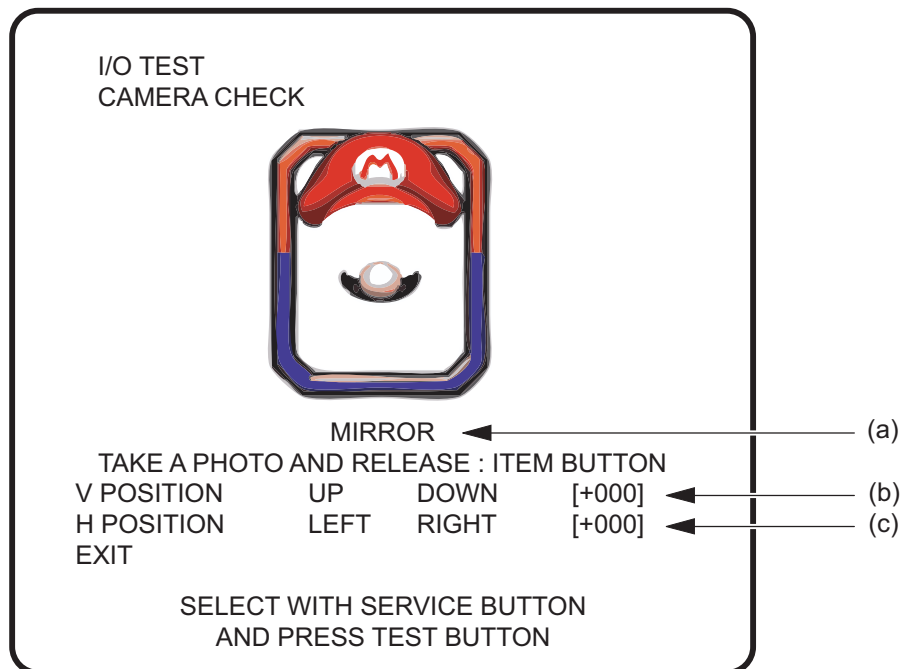

2. Press the Service button to select the required item then press the Test button.
3. Press the Service button to select 'EXIT' then press the Test button to return to the I/O Test Menu Screen.

- Standard settings (factory default) are indicated in green, others are in red.
- An image captured based on the current settings is shown in the centre of the screen.

(a) **MIRROR/PHOTO**

When the Item button is pressed, the camera takes a picture.

When a picture is taken, the captured still image is shown at the centre of the screen, and the indication below the image changes to "PHOTO". This will be the image shown on the race screen during the game.

When the Item button is pressed again, the still image changes to a moving image. In this mode the indication below the image changes to "MIRROR".

Set the image mode to "MIRROR" when adjusting the image quality or position.
Set the image mode to "PHOTO" when checking the image to be displayed during the game.

- (b) This adjusts the position of the camera image in a vertical direction.
When "V POSITION" is selected, the cursor moves to the "UP" position. To move the image up, press the Service switch. To move the image down, press the Test switch to move the cursor to "DOWN", then press the Service switch.
When the Test switch is pressed again, the cursor returns to the "V POSITION"
- UP: The numerical value increases, and the displayed image moves in an upward direction.
- DOWN: The numerical value decreases, and the displayed image moves in a downward direction.

- (c) This adjusts the position of the camera image in a horizontal direction. When "H POSITION" is selected, the cursor moves to the "LEFT" position. To move the image left, press the Service switch. To move the image down, press the Test switch to move the cursor to "RIGHT", then press the Service switch, When the Test switch is pressed again, the cursor returns to the "H POSITION"
- LEFT: The numerical value decreases, and the displayed image moves to the left.
- RIGHT: The numerical value increases, and the displayed image moves to the right.

Note:

- This game machine uses the namcam 2 camera to capture the image of the face of the game player. To ensure clear pictures, do not install the machine in any of the following places.
- Places where a bright light source such as the sun or spotlight directly enters the camera lens.
- Places where flashing lights such as strobes can cause large differences between light and dark.

Namcam2 camera adjustment method

To ensure proper operation of the camera (namcam2), adjust the camera as described below after installing the game machine and before first game play..

(1) Checking moving images

Make sure that moving pictures are shown at the center of the screen. When moving pictures are displayed, "MIRROR" is indicated below the image. If a still picture is displayed, press the Item button once.

(2) Adjusting the position

Make adjustments so that the face of the person sitting in the seat is positioned at the center. The adjustment procedure is described in (a) and (b) on page 52. It is recommended to set the position as shown below.

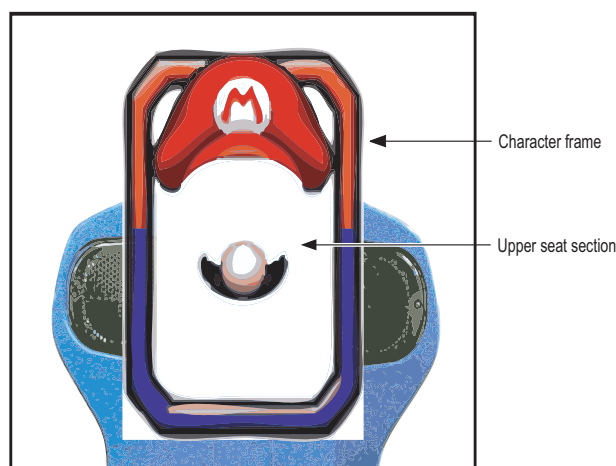

With the seat moved fully toward the front, make adjustments so that the seat and the character frame appear at the positions shown above.

(3) Checking still image

Sit in the seat and press the Item button to take a facial picture. A captured still image is shown during the game. Check the image quality and the position of the image display. If there is any problem, press the Item button again to display moving pictures, then conduct the adjustment described in (2).

6-2-4-3 Monitor Test

1. Press the Service button to select MONITOR TEST and press the Test button. The following screen is displayed.

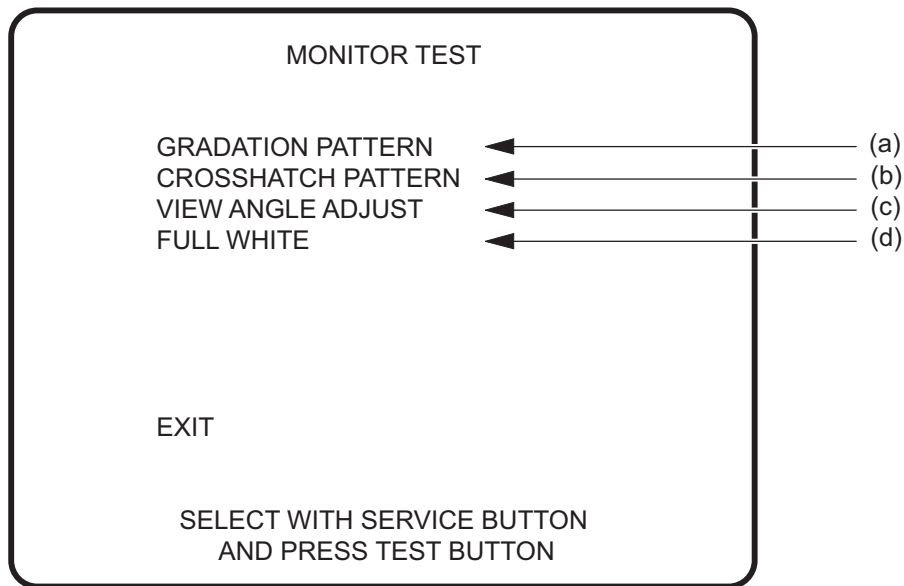

2. Press the Service button to select the required item then press the Test button. (Pressing the Test Button in a test will return to the above Monitor Test Screen.)
3. Press the Service button to select 'EXIT' then press the Test button to return to the Game Test Menu Screen.

Item	Description
(a) Gradation Pattern	Displays graduated colour bars for colour set-up
(b) Crosshatch Pattern	Displays a crosshatch for geometry set-up
(c) View Angle Adjust	Displays a white border for picture size set-up
(d) Full White	Displays a white square for brightness/contrast set-up

6-2-4-4 Sound Setting

1. Press the Service button to select SOUND TEST and press the Test button. The following screen is displayed.

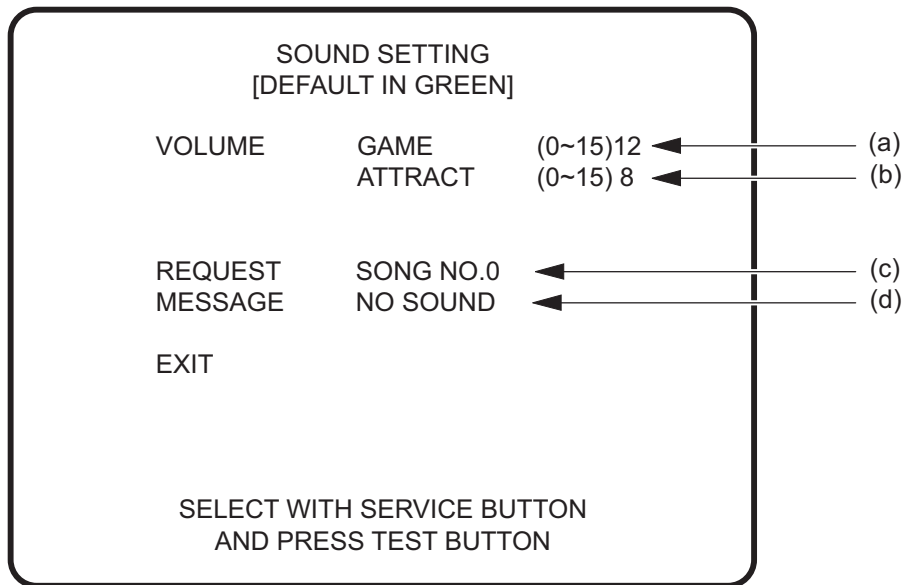

2. Press the Service button to select the required item then press the Test button.
3. Press the Service button to change the setting, then press the Test button.
4. Press the Service button to select 'EXIT' then press the Test button to return to the Game Test Menu Screen.

Item	Description	Factory Setting
(a) Game	Sets the volume during the Game - Adjustable (0 ~ 15)	12
(b) Attract	Sets the volume during the Attract Mode - Adjustable (0 ~ 15)	8
(c) Request Song No.	<p>A different sound will be produced for each number when the Test button is pressed</p> <p>0 No Sound</p> <p>1 Stereo Test (Sound will be played first from the Left speaker, then the Right speaker, then Both speakers)</p> <p>2 Plays a sample of music at the Game Mode volume.</p> <p>3 Plays a sample of music at the Attract Mode volume.</p>	0
(d) Message	<p>Displays the name of the sound selected with the REQUEST item</p> <p>0 No Sound</p> <p>1 Displays which speaker is producing sound. [LEFT] [RIGHT] [LEFT + RIGHT]</p> <p>2 SAMPLE(GAME)</p> <p>3 SAMPLE(ATTRACT)</p>	

6-2-4-5 Setting the Business Closing Time (CLOSE SETTING)

- This screen is only used on games that have a card reading facility.
Set all days to OFF
1. When the "CLOSE SETTING" is selected from the GAME TEST MENU screen, the following screen appears.
 2. Using the Service button, select a day of the week, and press the Test button. The hour indication of the selected day blinks. Use the service button to set the hours (24 hour system, 1-hour intervals).

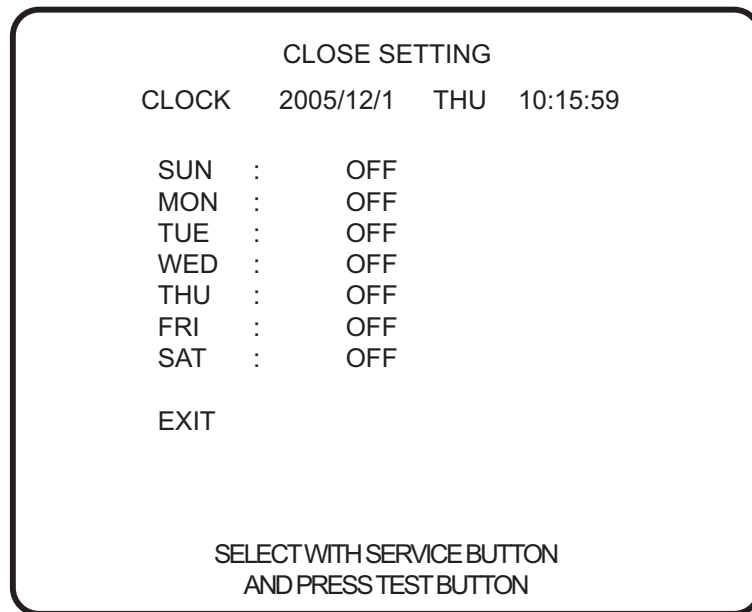

3. After all settings have been completed, use the Service Button to select EXIT, then press the Test Button to return to the Test Menu Screen

6-2-4-6 Book Keeping

Use this test to view book keeping data for the game, and to initialize the data and set factory defaults (Backup Memory Initialize).

1. Press the Service button to select BOOK KEEPING and press the Test button.
2. Press the Service button to select the required item then press the Test button.
3. Press the Service button to select 'EXIT' then press the Test button to return to the Game Test Menu Screen.

Data Clear

1. Press the Service button to select DATA CLEAR and press the Test button. The following screen is displayed.

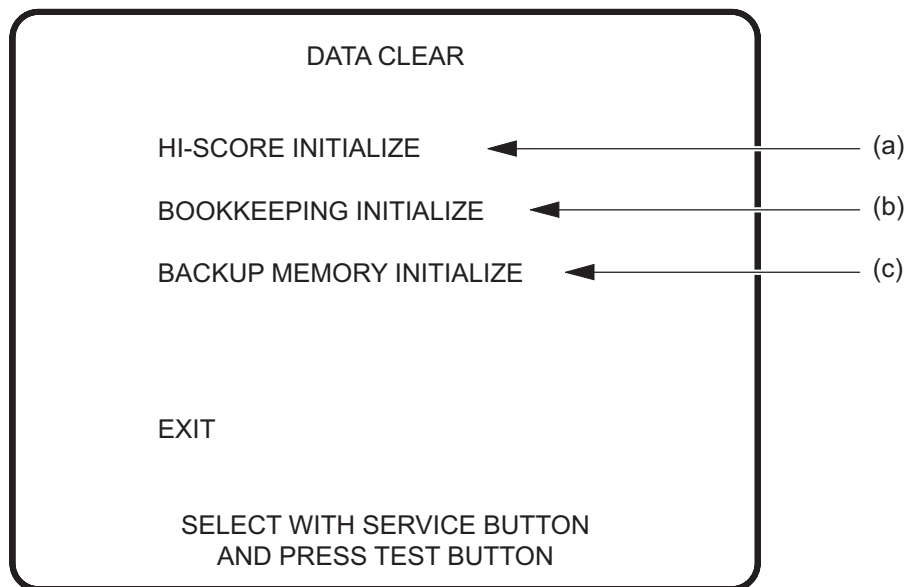

2. Press the Service button to select the required item then press the Test button.
3. Press the Service button to select YES or NO, then press the Test button.
4. Press the Service button to select 'EXIT' then press the Test button to return to the Game Test Menu Screen.

Item	Description
(a) HI-SCORE INITIALIZE	Resets high score data NO - score not reset YES - score reset.
(b) BOOK KEEPING INITIALIZE	Resets all Book Keeping data to 000 NO - data not reset YES - data reset.
(c) BACKUP MEMORY INITIALIZE	Sets all Game and Coin options to factory default. NO - data not reset YES - data reset

Note:

Ensure that Game Options and Coin Settings are reconfigured and the game is Initialized after conducting Backup Memory Initialize.

6-2-4-7 Others

1. Press the Service button to select OTHERS and press the Test button. the Following screen is displayed

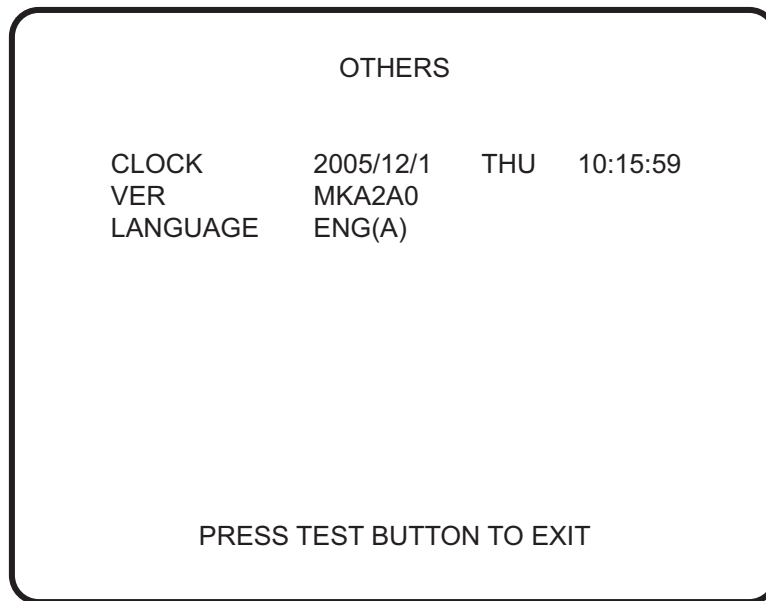

2. Press the Service button to select the required item then press the Test button.
3. Use the Service button to change the data, then press the Test button.
4. Press the Service button to select 'EXIT' then press the Test button to return to the Game Test Menu Screen.

Item	Description
(a) CLOCK	Set the Date and Time for the PCB Clock
(b) VER	Displays the Game Software Version data
(c) LANGUAGE	Sets the Language for on screen instructions

7. MAINTENANCE



- (GB)** Adjustment or maintenance on this machine should be carried out by qualified personnel only.
Ensure that the **POWER** to the machine is turned **OFF** before commencing any maintenance work. (Trouble shooting, service or repairs etc.)
- (D)** Einstellungen und Wartung des Gerätes dürfen nur von dafür qualifiziertem Fachpersonal vorgenommen werden.
Vor Beginn aller Wartungsarbeiten (Fehlersuche, Reparaturen etc.) muß der Netzstecker gezogen werden.
- (DK)** Justeringer eller vedligehold af denne maskine bør kun udføres af kvalificeret personale.
Sørg for, at strømmen til maskinen er slukket før der foretages nogen form for arbejde (fejlfinding, reparation etc.)
- (E)** Los ajustes y el mantenimiento de esta máquina deben ser realizados sólo por personal cualificado.
Asegúrese de que la máquina está desconectada antes de comenzar cualquier trabajo de mantenimiento (reparaciones, resolución de problemas, etc.)
- (F)** L'installation, le service, le réglage, ou la maintenance doivent être effectués uniquement par les personnes qualifiées.
S'assurer que l'interrupteur soit sur OFF avant de commencer tout travail de maintenance (localisation d'une panne, réparations, etc.)
- (GR)** Μετατροπές ή επιδιορθώσεις στα μηχανήματα πρέπει να γίνονται μόνο από εξουσιοδοτημένα άτομα.
Να είναι σίγουρα κλειστό το ρεύμα πριν οποιαδήποτε δουλειά στο μηχάνημα.
- (I)** Regolazioni e manutenzione su questa macchina devono essere fatti solo da personale specializzato.
Assicurarsi che la macchina sia SPENTA prima di incominciare qualsiasi lavoro di manutenzione (guasti, riparazioni etc.)
- (N)** Justering eller vedlikehold på denne maskinen skall bare utføres av kvalifiserte personell.
Forsikre deg om at strømmen er slått av før du påbegynner noe som helst vedlikeholdsarbeid (feilsøking, reparasjon osv.)

- (NL)** Aanpassingen of onderhoud aan deze machine dient alleen uitgevoerd te worden door bekwaam personeel.
Zorg ervoor dat de machine UITgeschakeld is voordat er enig onderhoudswerk wordt verricht (troubleshooting, reparaties etc.)
- (P)** Afições ou manutenção nesta maquina, deverão ser efectuadas sómente por pessoal qualificado.
Certifique-se que a maquina se encontra desligada sempre que iniciar qualquer tipo de trabalho de manutenção. (identificação de avarias, reparação etc.)
- (S)** Justeringar och underhåll på denna maskin skall endast utföras av kvalificerad personal.
Försäkra dig om att strömmen är avstängd innan underhållsarbete påbörjas (felsökning, reparationer etc.)
- (SF)** Tätä laitetta saa säätää tai huoltaa vain siihen ammattipätevyyden omaava henkilökunta.
Varmista, että laite on kytketty POIS PÄÄLTÄ ennen työn aloittamista.

7-1 Self Test

The machine automatically executes a self test immediately after the power is turned ON. When the self test is OK, the start-up screen appears on the monitor after a short while. If there is an error, an error buzzer is sounded or an error message is displayed on the monitor, and the game stops operating.

- **Do not touch the steering wheel while the self test is in progress. If the steering wheel is operated during the test, the game may display an error message and stop operating.**

7-2 Error Displays

7-2-1 Errors related to the Steering Assy.

Symptom	Main Course	Action
The self test results in the display error E10 "An error was generated in the steering wheel" on the monitor, and the game does not start up. (There is an abnormal rotation in the Steering Motor Assy)	The connector is disconnected	Connect the connector
	The potentiometer is defective	Replace the Potentiometer
	The fuse is blown	Replace the fuse
	The Steering PC Board is defective	Replace the Steering PC Board
	The motor is defective	Replace the motor.
The self test results in the display error E11 "An error was generated in the steering wheel" on the monitor, and the game does not start up. (There is an abnormal rotation in the Steering Motor Assy)	The potentiometer is defective	Replace the potentiometer
The self test results in the display error E12 "An error was generated in the steering wheel" on the monitor, and the game does not start up. (There is an abnormal rotation in the Steering Motor Assy)	The Steering PC Board is defective	Replace the steering PC Board
	The motor is defective	Replace the motor
The self test results in the display error E20 "An error was generated in the steering wheel" on the monitor, and the game does not start up. (There is an abnormal rotation in the Steering Motor Assy)	The connector is disconnected	Connect the connector
The self test results in the display error E** "An error was generated in the steering wheel" on the monitor, and the game does not start up. (** indicates a number other than 10,11,12 or 20)	The Steering PC Board is defective	Replace the steering PC Board

Symptom	Main Course	Action
The self-test after power On results in the display of the "Item Button Error" message on the monitor, and the machine does not start. (The Item button remains in ON status.)	The Item button is being pressed when the machine starts up.	Remove your hand from the Item button and restart the machine
	The Item button is remaining in the depressed condition.	Contact your distributor.
The monitor displays the "Wheel error 07" message during game play, and the machine stops operating.	The potentiometer is faulty	Replace the potentiometer
The monitor displays the "Wheel error 08" message during game play, and the machine stops operating.	The steering PC Board is faulty	Replace the Steering PC Board
The monitor displays the "Wheel error ***" message during game play, and the machine stops operating.. (** indicates a number other than 07 or 08)	The steering PC Board is faulty	Replace the Steering PC Board

7-2-2 Errors related to the Camera Assy.

Symptom	Main Course	Action
The self-test after power On results in the display "Camera Error" message on the monitor, and the machine does not start	The connector is disconnected	Connect the connector securely
	The namcam2 (camara) is defective	Replace the namcam2 (camera).
The Attract screen displays (You may not use the camera now" message.	The camera is turned off	Turn the camera on. (see 6-2-2-1 page 48)
The Attract screen does not display the image captured by the camera.	Communication is interrupted	Ensure that the communication cables are connected securely and the ID settings are correct
The monitor displays the "You may not use the camera now" message during the photoshooting in game play	The camera is turned Off	Change the camera setting from Off to On. (see 6-2-2-1 page 48)

7-2-3 Errors related to Communications.

Symptom	Main Course	Action
The monitor displays the "Link error occured" message during game play	Communication is interrupted	Ensure that the communication cables are securely connected, and restart all connected game machine units

7-3 Replacing the Fluorescent Tube

1. Remove 2 off pozi head screw (M5x12), and remove the fluorescent Enclosure
2. Replace the Fluorescent Tube or Starter.

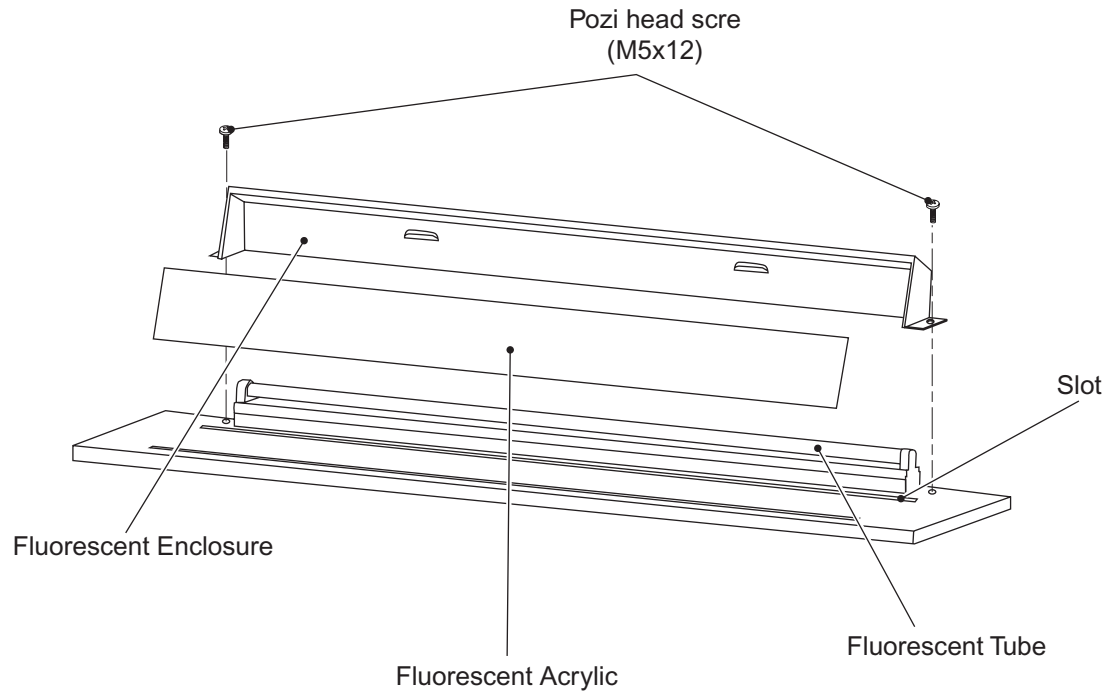

3. Reassemble in reverse order.

Note: When replacing the Fluorescent Enclosure ensure that the Fluorescent Acrylic is fitted correctly to the Enclosure, and it engages in the slot on the base of the Header Assembly.

7-4 Replacing the Pushbutton Switches

1. Remove 6 off security screw (M5x12) to release the Play Panel Vac-Form.

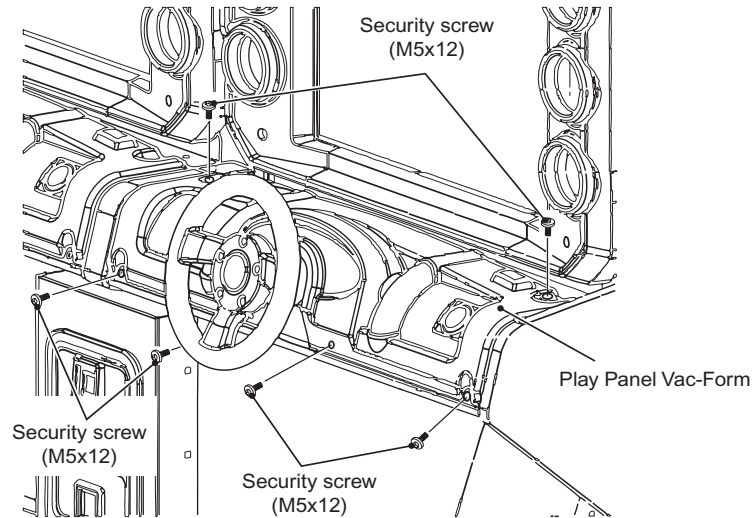

2. Raise the Play Panel Vac-Form only sufficient to disconnect the connector.
3. Remove the Play Panel Vac-Form

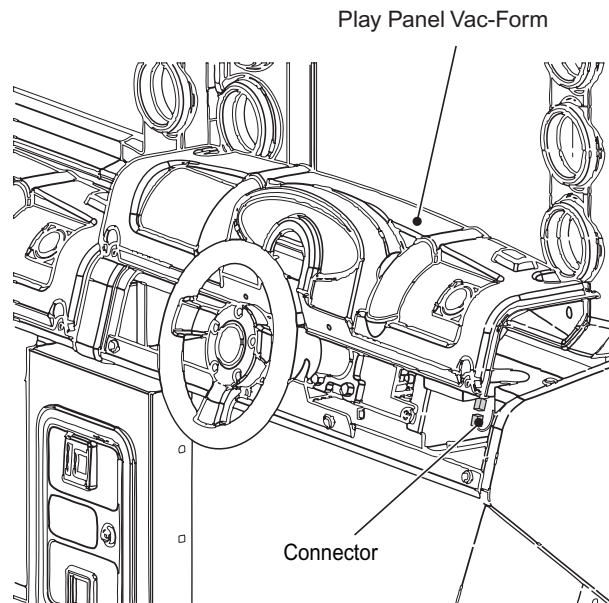

4. Remove the Switch Assy by pulling it straight out from the Switch Body.
5. Remove the Switch Body by undoing the retaining nut.

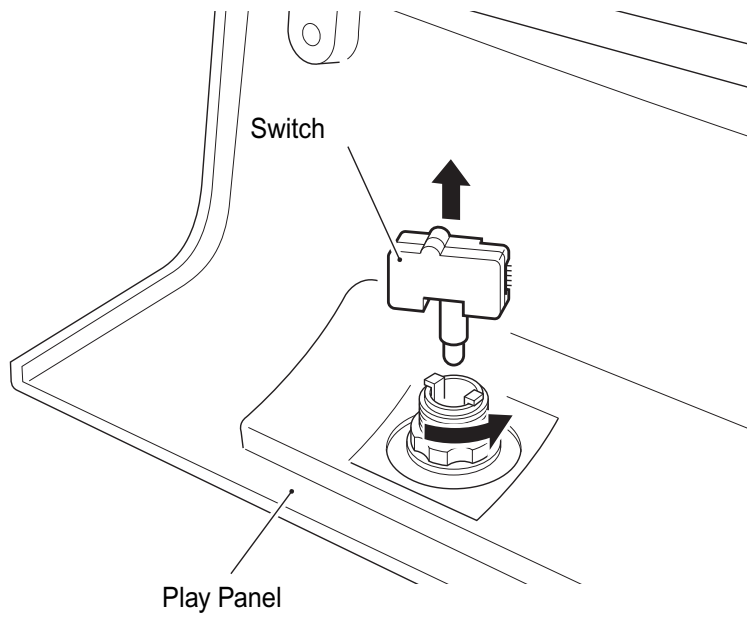

5. Remove the lamp by pulling it straight out from the Switch Assy.

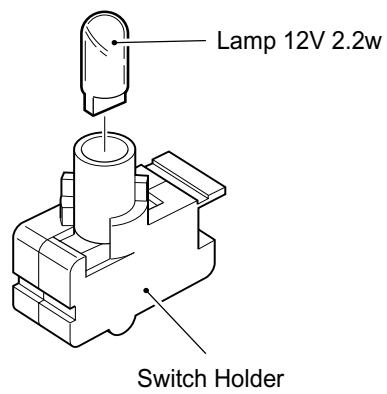

6. Reassemble in reverse order.

7-5 Replacing the Camera Assy

1. Remove 4 off security screw (M5x20) to release the Monitor Surround.

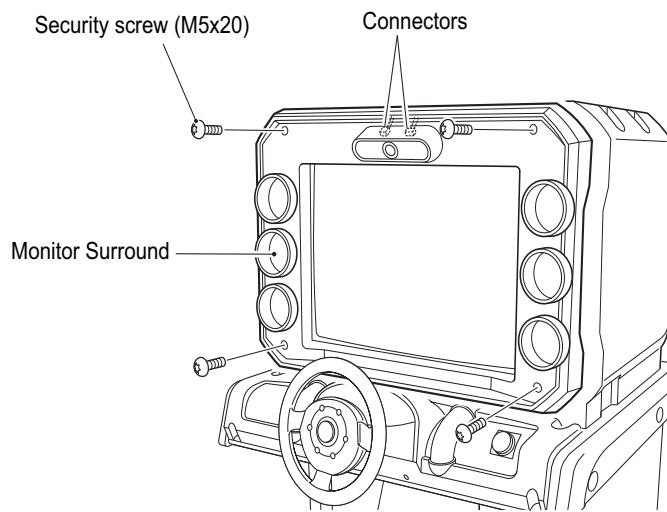

2. Remove the Monitor Surround only sufficient to disconnect the connectors.
3. Disconnect the connectors.
Note: Undo the cable clamp when removing the connectors.

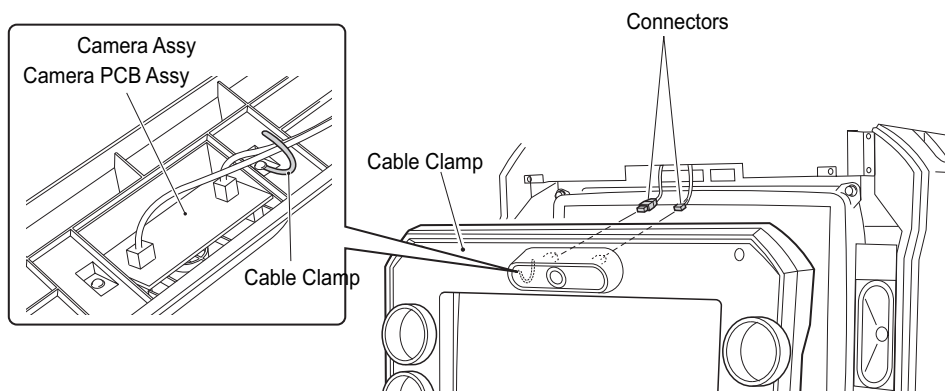

4. Remove 4 off pozi head screws (M3x6) and remove the Camera PCB Assy.

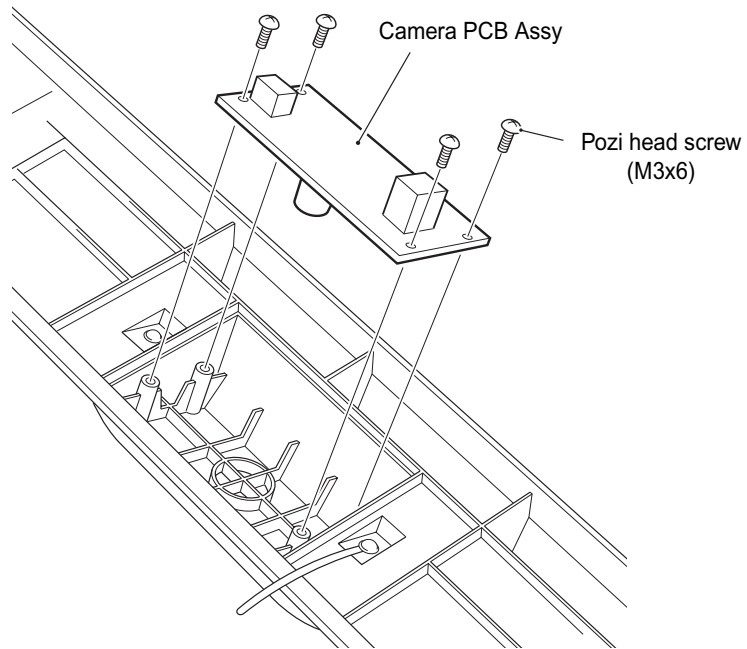

5. Reassemble in reverse order.

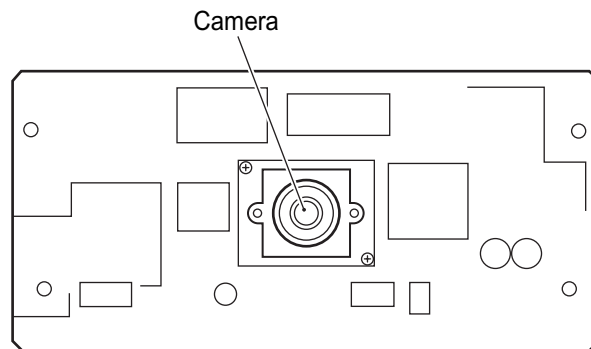

7-6 Replacing the Steering PC Board Fuse

1. Remove the rear maintenance panel from the Monitor Cabinet.
2. Replace the Fuse.

Note: Never use a fuse other than the specified type (250v 5A). Use of a different fuse could result in a fire.

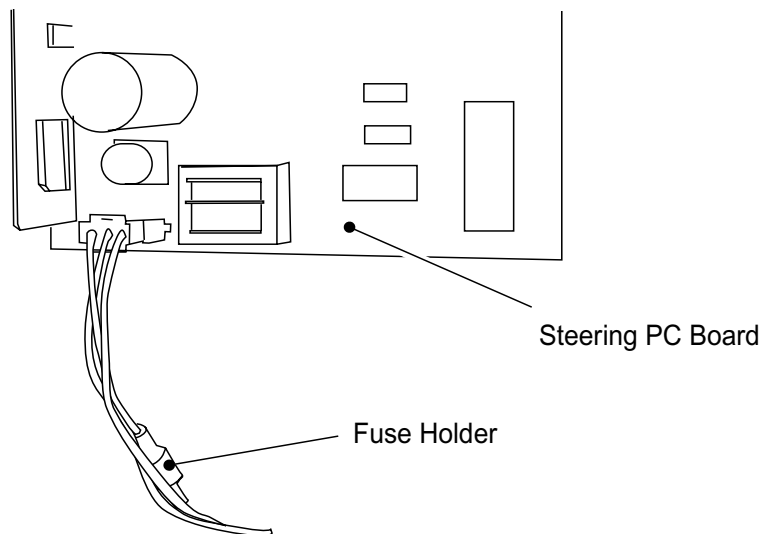

7-7 Removing the Steering PC Board

1. Disconnect the six connectors.
2. Using long-nosed pliers, release the locking supports and remove the PC Board.
3. Reassemble in reverse order.

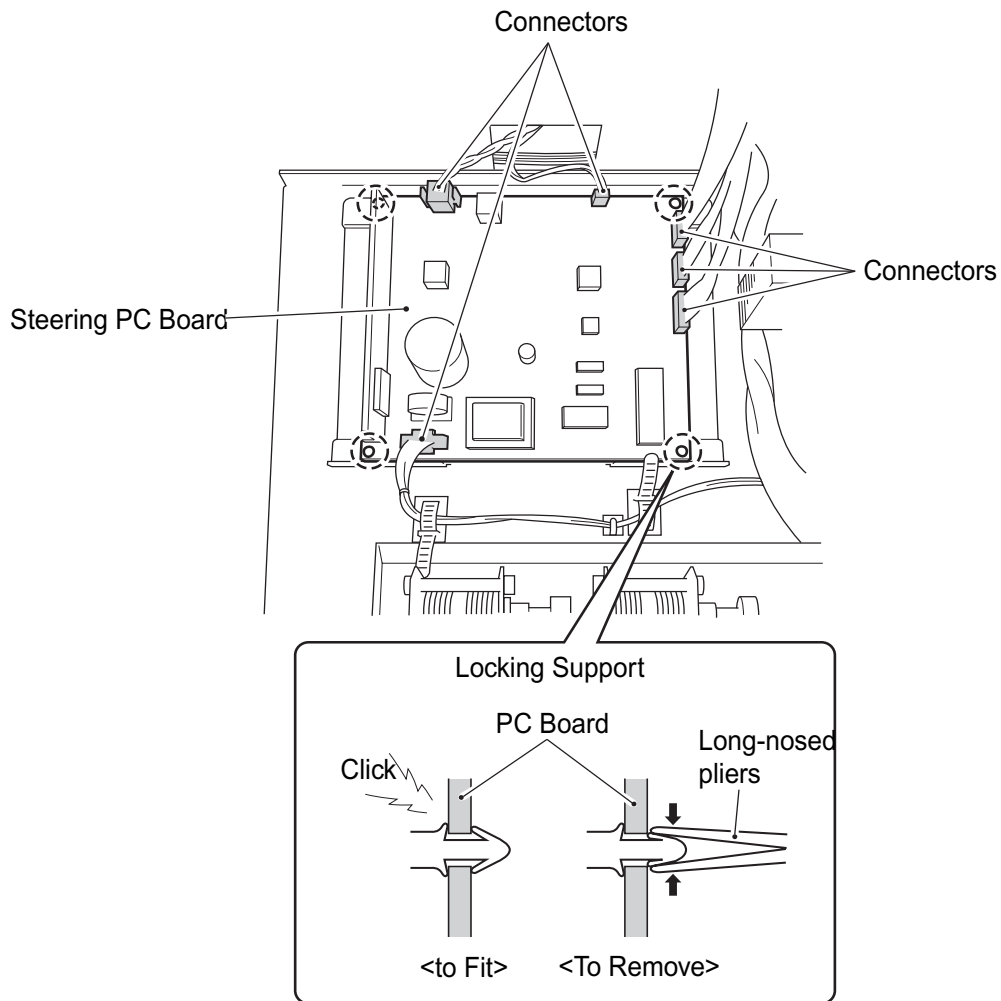

7-8 Removing the Steering Assy

1. Remove the Play Panel Vac-Form. (see 7-4 page 65)
2. Disconnect the Steering Assembly connectors.
3. Remove 4 off Hex nut (M8), 4 off Spring washer (M8) and 4 off Hex Socket head screws (M8x25) and withdraw the Steering Assembly.

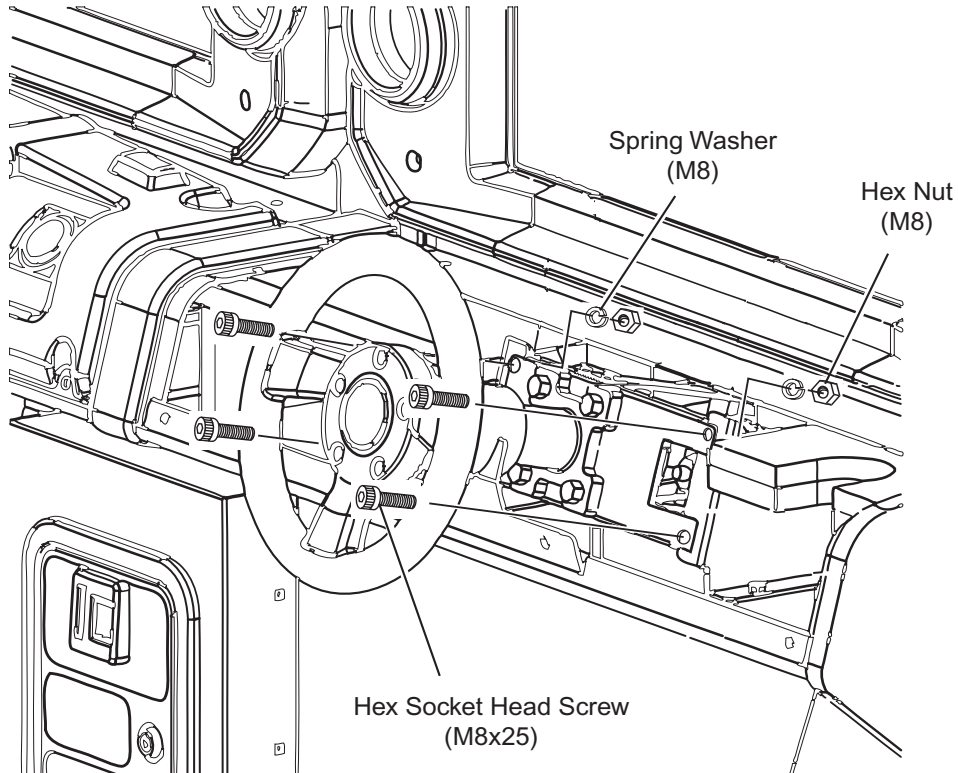

4. Reassemble in reverse order

Note: After replacing the motor or drive belt ensure that the game is re-initialized. (see 5-4 page 40)

7-9 Replacing the Steering Potentiometer

1. Remove the steering assembly. ([see 7-8 page 71](#))
2. Remove 2 off hex socket head screws (M4x10) holding the potentiometer mounting bracket to the front plate.
3. Slacken the grub screw (M4x10) and remove the potentiometer complete with the mounting bracket.

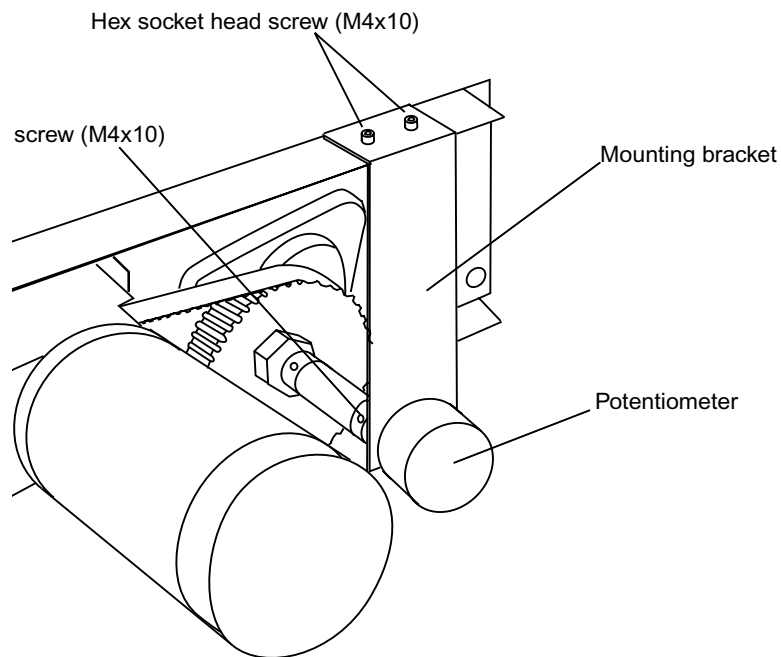

4. Replace the potentiometer taking care to replace the correct colour wire to the correct terminal.
5. Reassemble in reverse order.

Note: *When refitting the potentiometer ensure that the grub screw engages on the flat of the potentiometer shaft.*

6. **After replacing the potentiometer ensure that the game is re-initialized.** ([see 5-4 page 40](#))

7-10 Replacing the Steering Motor or Drive Belt

1. Remove the steering assembly. ([see 7-8 page 71](#))
2. Slacken the adjustment screw (hex head M6x60).
3. Slacken the 4 off hex nuts (M5) to remove the tension from the belt.

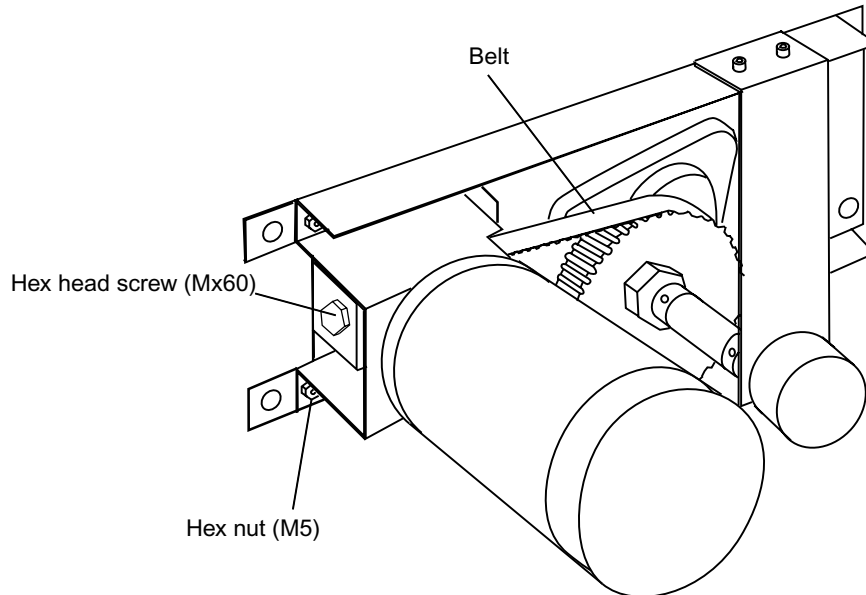

4. Replace the drive belt.
5. Remove 4 off pozi head screws (with flat and spring washers) and replace the Motor.
6. Refit (finger tight) the pozi head screws (with flat and spring washers).
7. Tighten the adjustment screw (M6x60) to tension the belt correctly.
Note: Do not over tension the drive belt.
8. Retighten the pozi head screws (with flat and spring washers).
9. Refit the steering assembly.

Note: After replacing the motor or drive belt ensure that the game is re-initialized.
([see 5-4 page 40](#))

7-11 Removing the Steering Wheel

1. Remove 5 off security screws.
(Make sure that you hold the wheel when removing the screws to prevent the wheel falling and damaging the switch wires.)

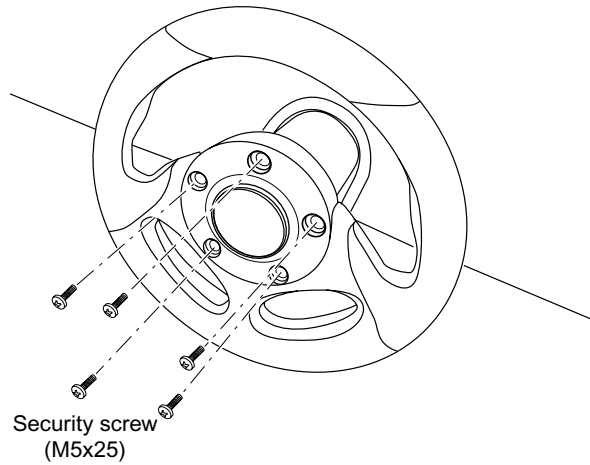

2. Remove the Switch/Lamp holder assembly by pulling it straight out from the Steering Wheel

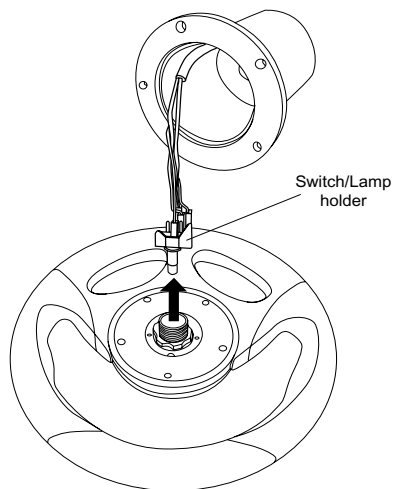

3. Reassemble in reverse order..

Note: After replacing the motor or drive belt ensure that the game is re-initialized.
(see 5-4 page 40)

7-12 Removing the Pedal Assy

1. Remove 4 off button head screws (M5x20).
2. Withdraw the pedal assembly only sufficiently to disconnect the connectors.

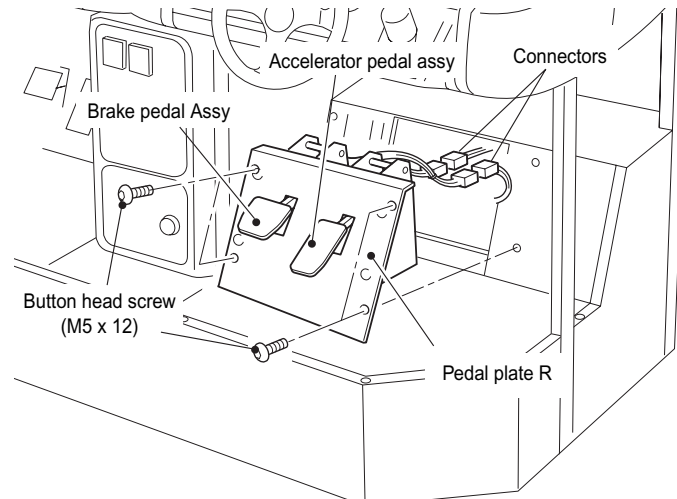

3. Remove the pedal assembly.
4. Reassemble in reverse order

7-12-1 Replacing the Pedal Potentiometer

1. Remove the pedal assembly. ([see 7-12 page 75](#))
2. Slacken the hex socket screw (M4x8) and remove the Gear.

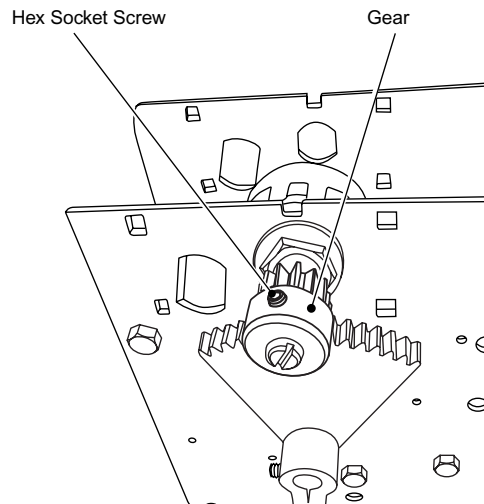

3. Remove the Hex Nut and Washer and replace the potentiometer ensuring that the correct colour wires go to the correct terminals.

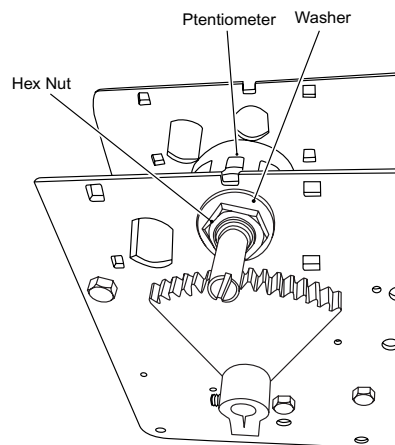

Note: When replacing the potentiometer ensure that before refitting the gear the potentiometer shaft is turned fully clockwise and then back anti-clockwise $\frac{1}{8}$ turn.

4. Reassemble in reverse order.

Note: After replacing the potentiometer ensure that the game is re-initialized. ([see 5-4 page 40](#))

7-13 Removing the Monitor

Note: The Monitor is heavy, ensure that at least two (2) people are used to remove the monitor

1. Remove 4 off pozi head screw (M5x12), and remove the Monitor Rear Panel.

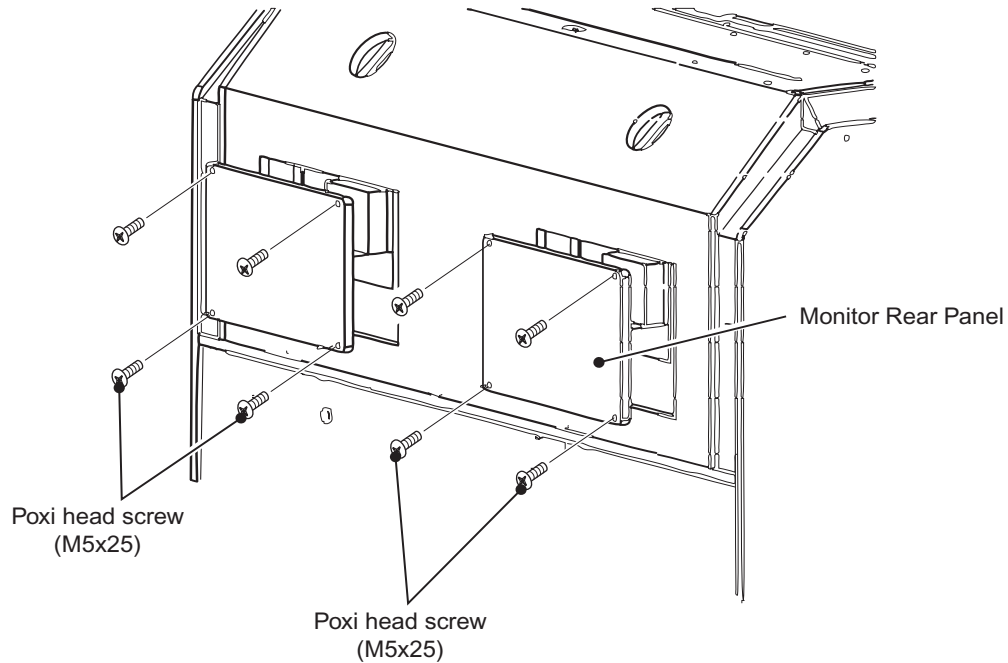

2. Disconnect the monitor connector from the TRIFORCE Game PC Board Assy, and the monitor power cable located in the bottom of the Monitor Cabinet.

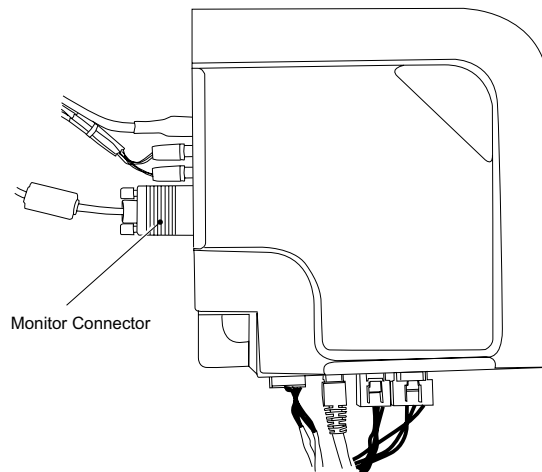

3. Remove the Play Panel. (see 7-4 page 65)
4. Remove the Steering Assembly. (see 7-8 page 71)
5. Remove 4 off Security screw (M5x12) and remove the Monitor Surround.

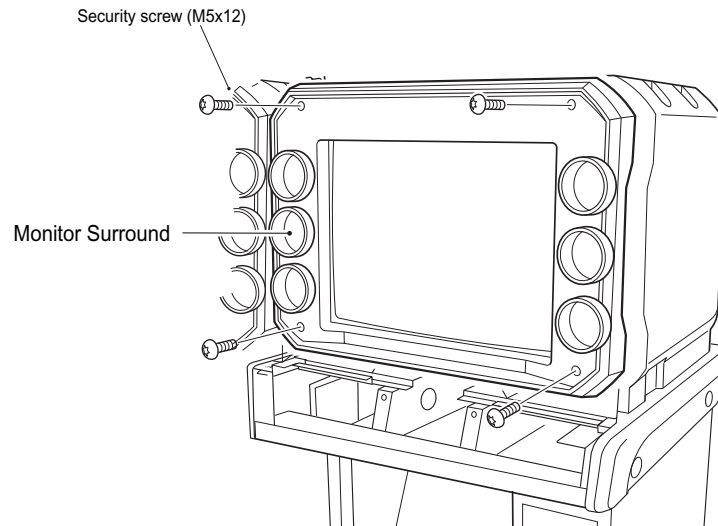

6. Remove 4 off Security screw (M5x12) and remove the Top Arm.
7. Remove the 2 off Security screw (M5x12) and remove the Bottom Arm.

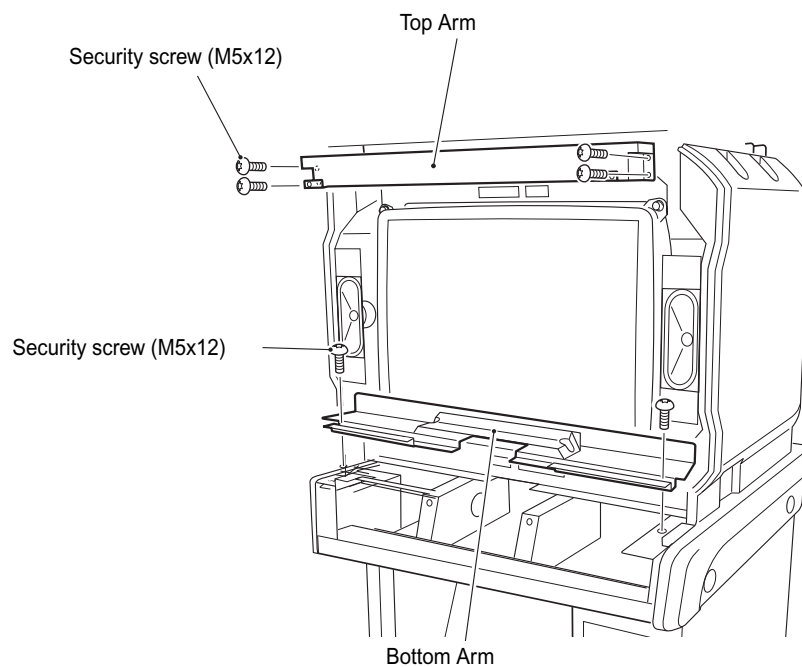

8. Remove 4 off Pozihed screws (M8x20) (with flat and spring washers) and 4 off Flat washers (M10) that are retaining the Monitor.

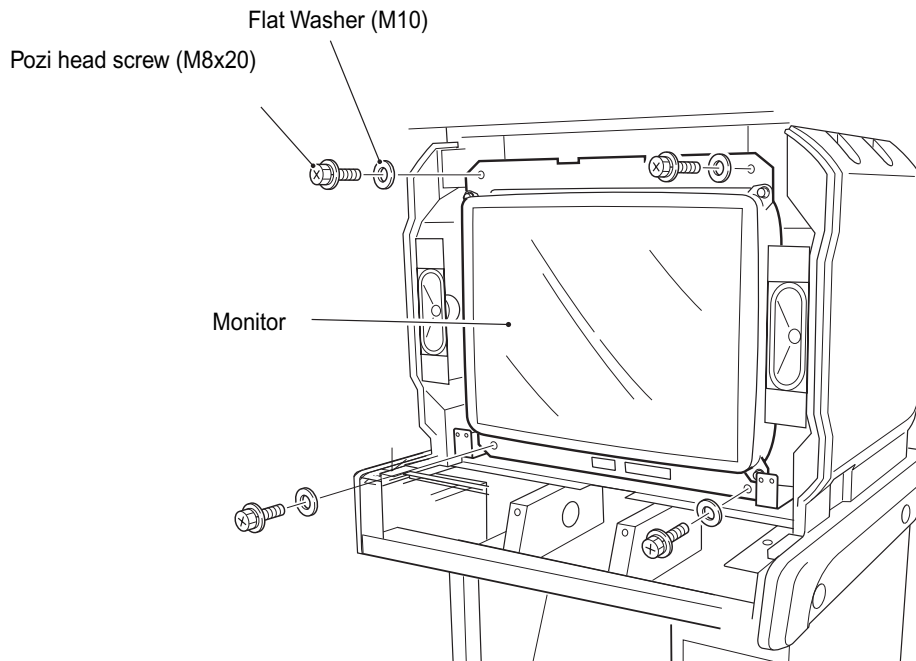

9. Tilt the Monitor forward, and the remove the Monitor from the front of the cabinet.

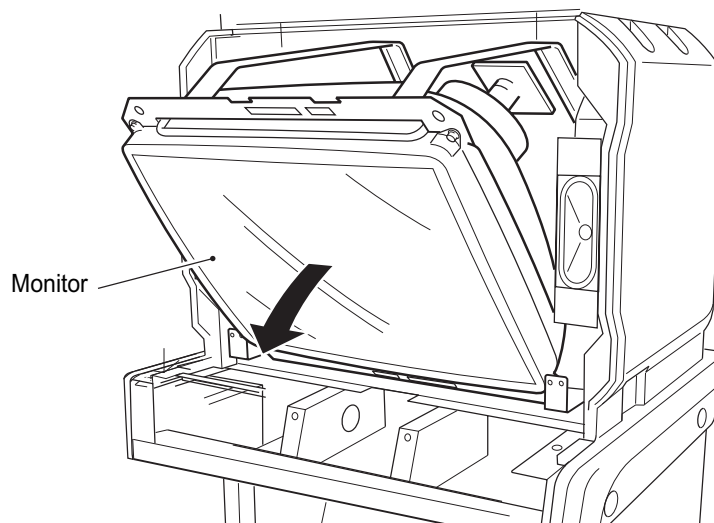

10. Reassemble in reverse order.

7-14 Removing the FCA PC Board

1. Remove the back door from the Monitor Cabinet.
2. Disconnect the connectors.
3. Disengage the 4off locking supports, and remove the FCA PC Board.Drive.

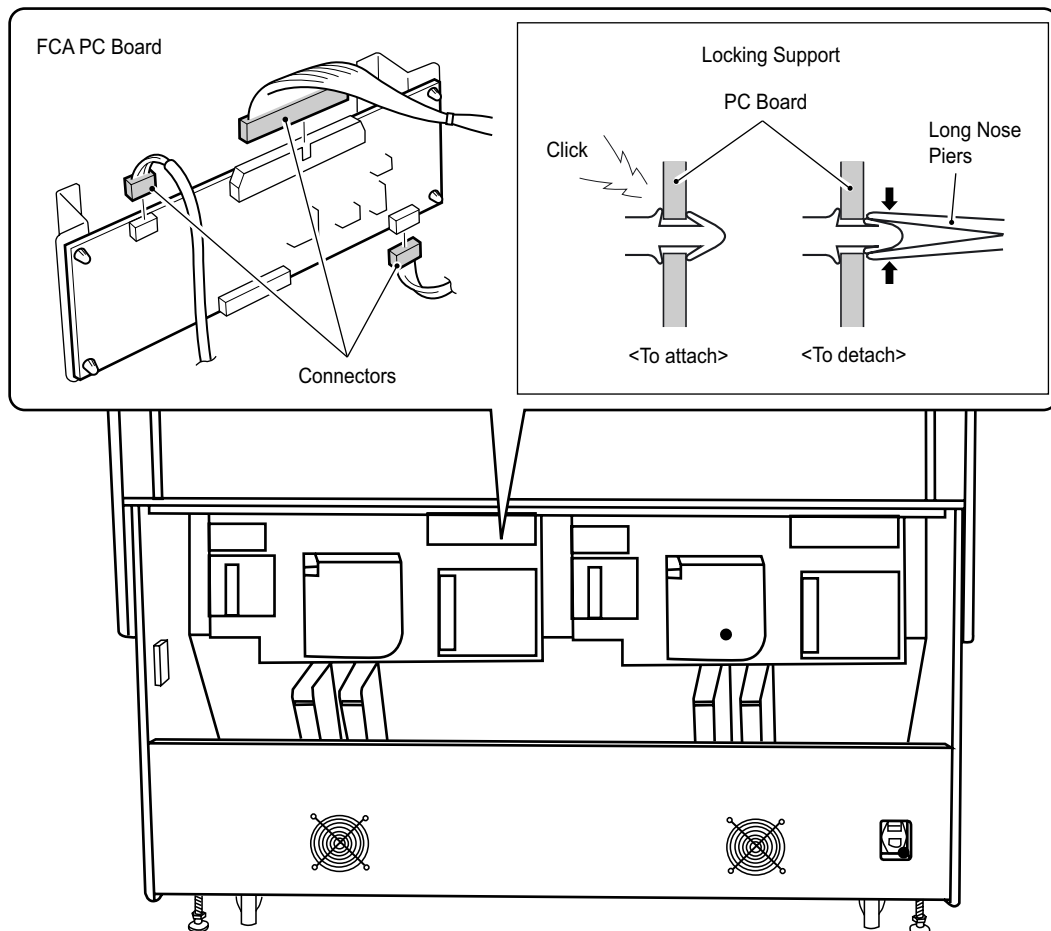

4. Reassemble in reverse order.

7-15 Removing the TRIFORCE PC Board

1. Remove the back door from the Monitor Cabinet.
2. Disconnect the connectors.
3. Remove 3 off pozi head screws (M4x12) and remove the TRI-FORCE PCB

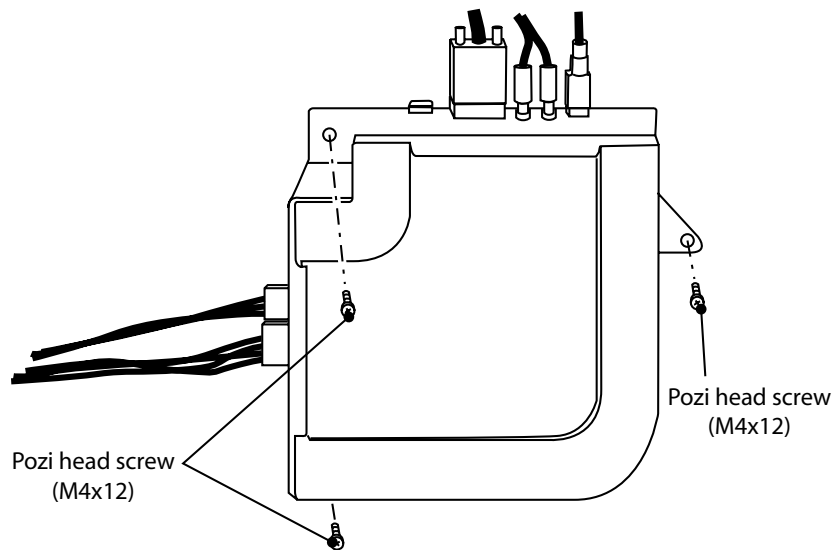

7-16 Removing the Sound PC Boards

1. Remove the back door from the Monitor Cabinet.
2. Disconnect the connectors.
3. Disengage the 4off locking supports, and remove the FCA PC Board.

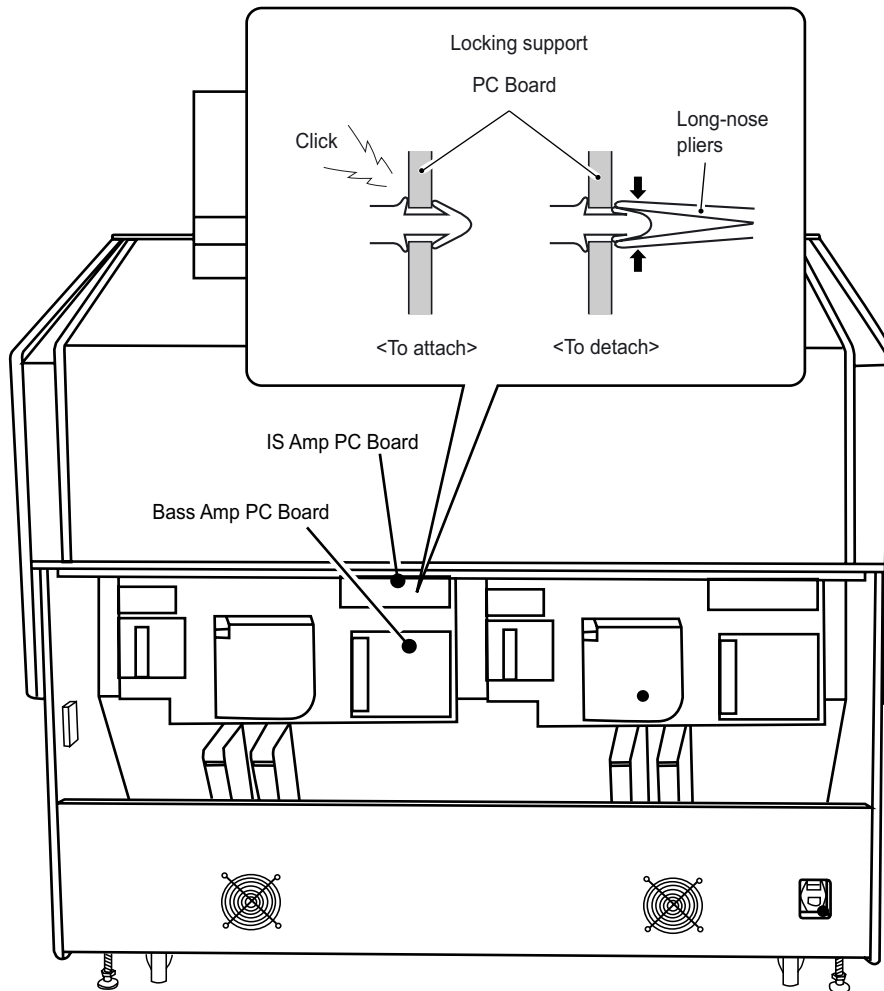

4. Reassemble in reverse order.

8. PARTS

8-1 Monitor Cabinet

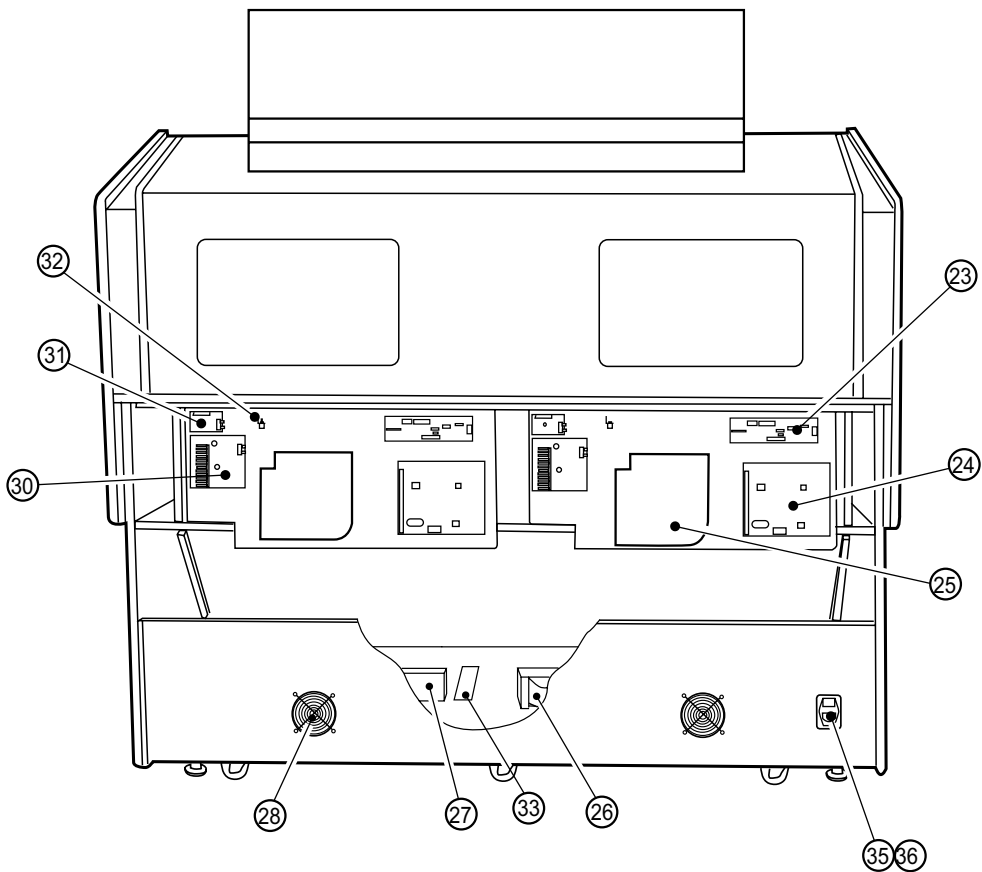
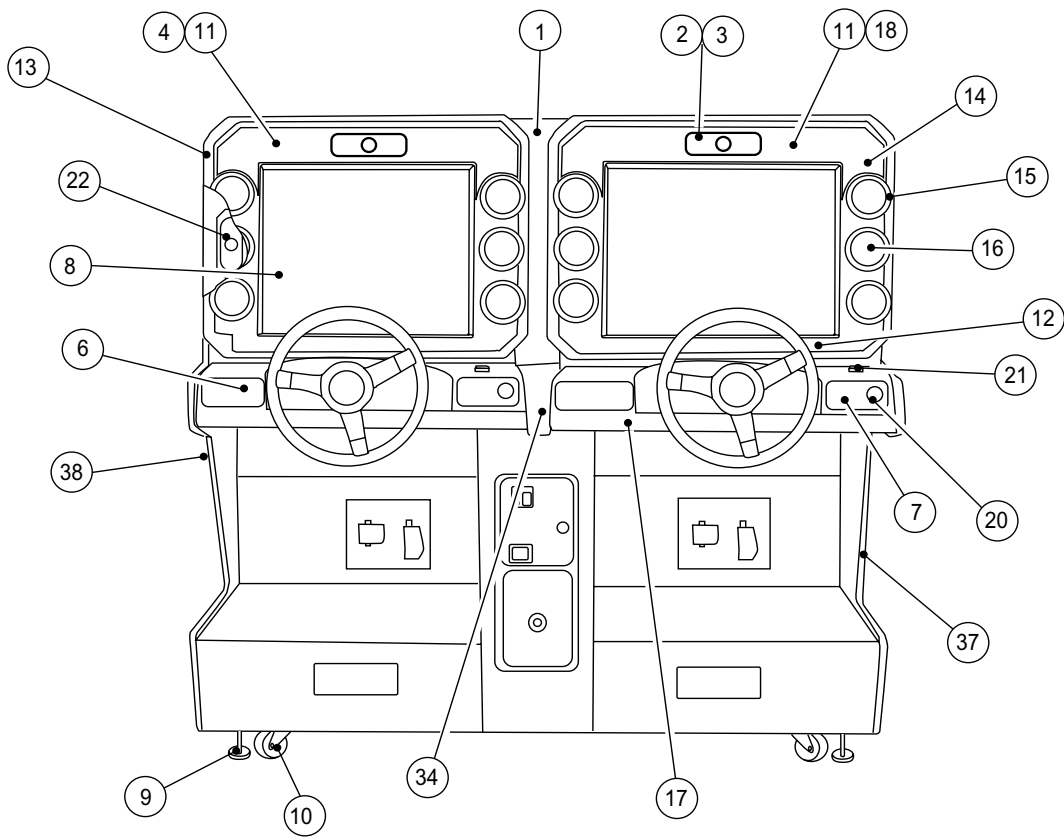

Item	Description	Part No
1	Monitor Centre Joint Vac-Form	47000820
2	Camera Cover	XMK-CAMERAMASK
3	Camera Decal	30000243
4	Monitor Vac-Forml - LHS	40000834
5	Monitor Vac-Form - RHS	40000835
6	Play Panel Decal - A	40000839
7	Play Panel Decal - B	40000840
8	Monitor (Pantronic 31kHz Flat Screen w/o Remote)	84000130
9	Adjustable Foot - M16x95	88300079
10	Swivel Castor - 75mm	59000005
11	Monitor Injection Moulding - Top	XMK-MASK A
12	Monitor Injection Moulding -Bottom	XMK-MASK B
13	Monitor Injection Moulding -LHS	XMK-MASK L
14	Monitor Injection Moulding -RHS	XMK-MASK R
15	Circular Injection Moulding	XMK-SPEAKER RING
16	Monitor Speaker Mask	XMT-SPEAKER MASK
17	Playpanel Vac-Form	47000811
18	Monitor Vac-Form Top Decal - RHS	40000835
20	Start Pushbutton - Red	60200211
21	Credit Available When Lit Button	60200215
22	Monitor Woofer 10w Shielded	62000168
23	FCA PC Board	X5GP-FCAPCB
24	Steering Control PC Board	XMK-STEERING PCB
25	TRI-FORCE Rack Assy	XMK-TRIFORCE
26	Steer PCB Transformer	67700026
27	Switchmode Power Supply - MPU150-4530(M) - 3v3/5v/12v	83000014
28	Fan 4%" 230v	67000015
29	Switching Hub	47000817
30	PBass PCB	XRR5-BASSAMPPCB
31	IS Amp PCB	XMZ-ISAMP
32	D/Gang Potentiometer 200k .05w	76000002
33	Voltage Phasing PCB	47000757
34	Play Panel Centre Joint Vac-Form	47000821
35	Schaffner Mains-In Filter Assy	62500010
36	Schaffner Boot	66000017
37	Monitor Cabinet Side Decal - RHS	40000832
38	Monitor Cabinet Side Decal - LHS	40000833

8-2 Seat Base Assembly

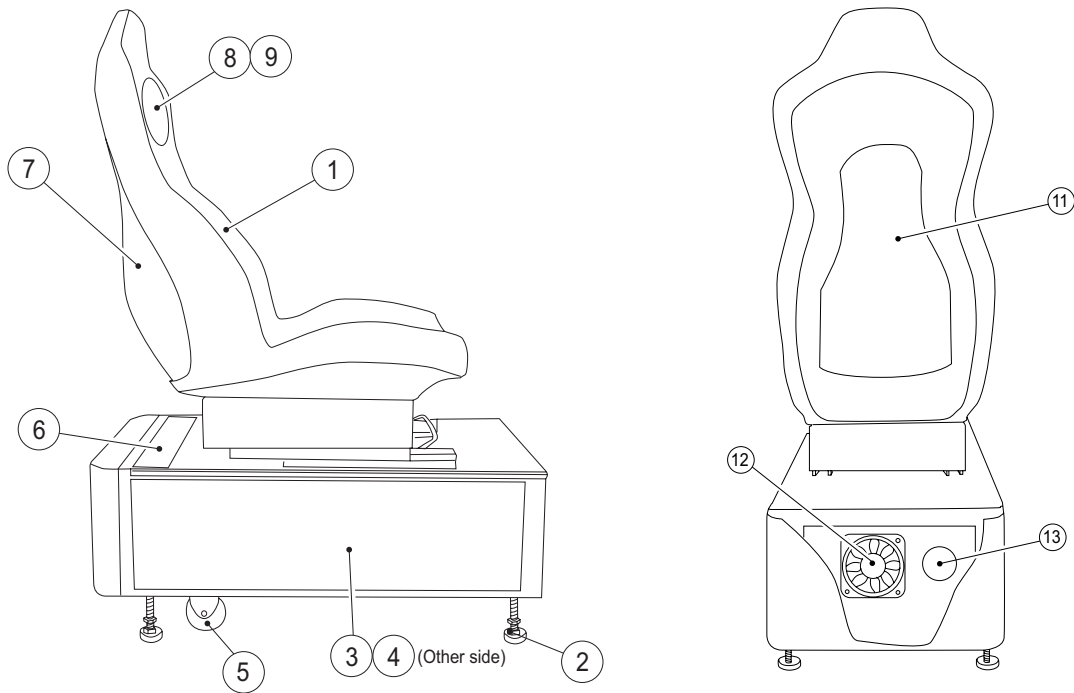

Item	Description	Part No
1	Seat Moulding - Red	88300602
2	Adjustable Foot - M16 x 95	88300079
3	Seatbase Side Decal - RHS	40000838
4	Seatbase Side Decal - LHS	40000837
5	Fixed Castor - 75mm	59000010
6	Seatbase Warning Decal	40000781
7	Seat slide Mechanism	88300680
8	Speaker 4%" 20watt	62000006
9	Speaker Cover -LHS	88300603
10	Speaker Cover - RHS	88300604
11	Seat Rear Decal	40000836
12	Bass Loudspeaker B13LR92-51F	XMT-BASSSPEAKER
13	Bass Speaker Port	46000837

8-3 Header Assembly

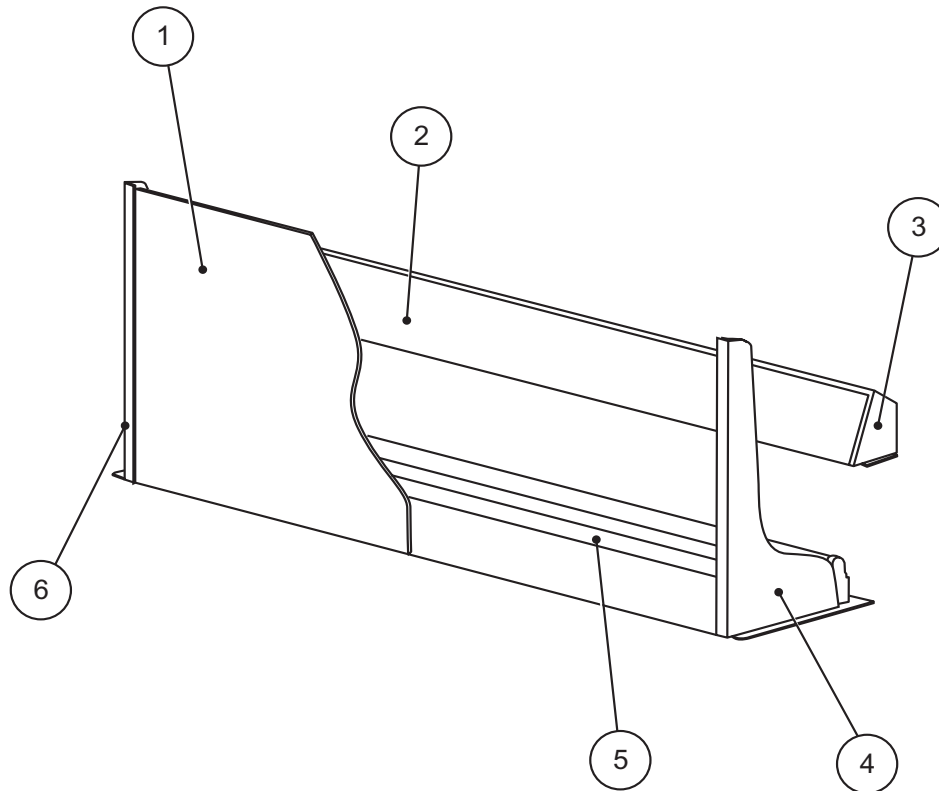

Item	Description	Part No
1	Pop Acrylic Front	30000242
2	Fluorescent Acrylic	30000100
3	Fluorescent Cover Housing	47000823
4	Pop Side Frame - RHS	47000824
5	Fluorescent Assembly 1200mm	64000045
6	Pop Side Frame - LHS	47000825

8-4 Steering Assembly

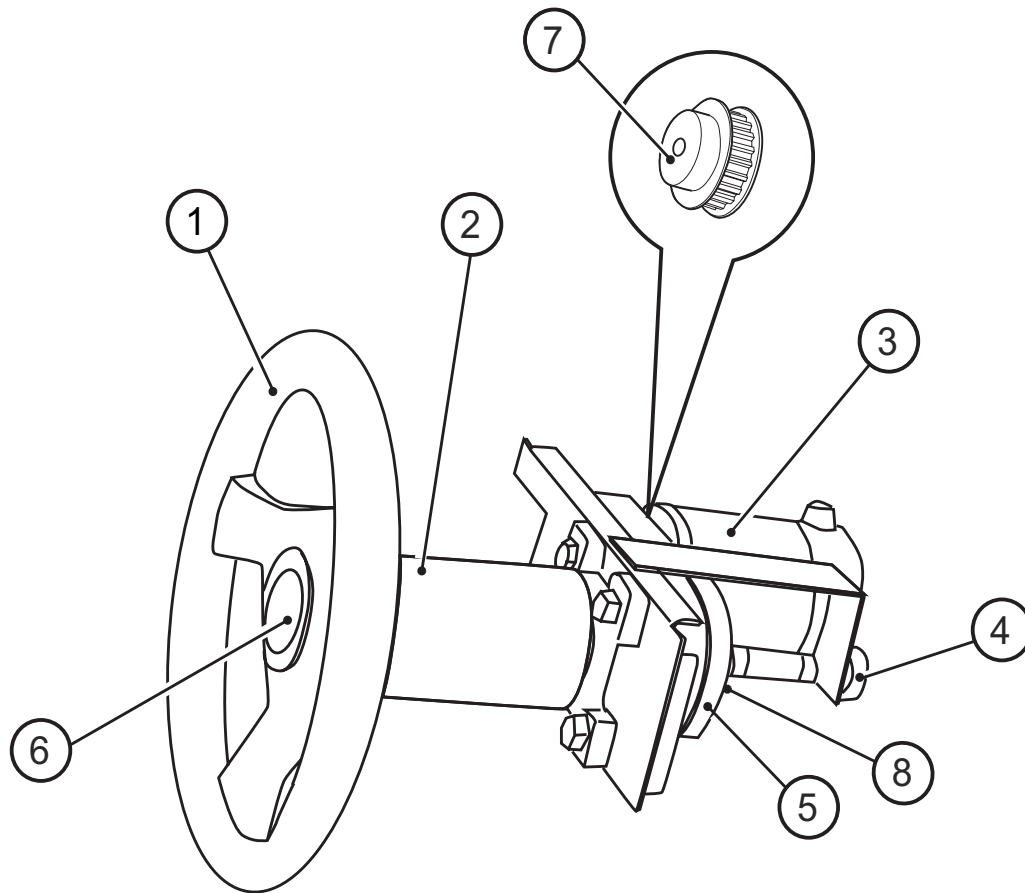

Item	Description	Part No
	Steering Assy - Complete	88800132
1	Steering Wheel	81500359
2	Steering Boss - Special	81500358
3	Steering Motor	88800040MK
4	Potentiometer	X008-022
5	Steering Belt	81500376
6	Steering Wheel Button Assy	88800143
7	Pulley C-40-025048-Plastic	81500375
8	Pulley C-GA-TX03600-Metal	81500377

8-5 Accelerator/Brake Pedal Assembly

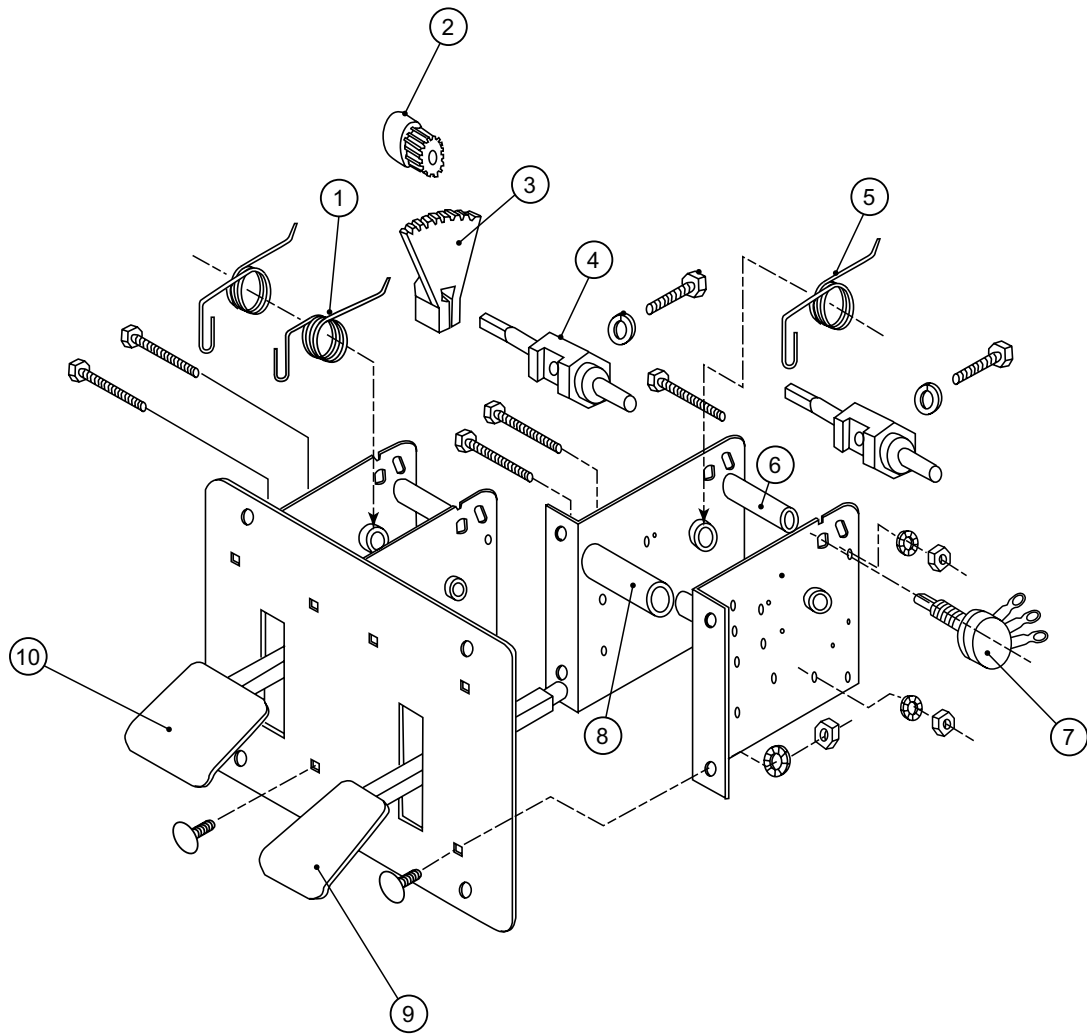

Item	Description	Part No
	Pedal Assembly - complete	XMK-Pedal
1	Pedal Spring - RHS	81500303
2	Metal Pot Gear	81500047
3	Segment Gear	81500048
4	Pedal Shaft	81500301
5	Pedal Spring - LHS	81500040
6	Bumper	81500302A
7	Potentiometer	88800133
8	Bumper	81500302
9	Accelerator Pedal	88800260
10	Brake Pedal	88800122

8-6 Service Bracket Assembly

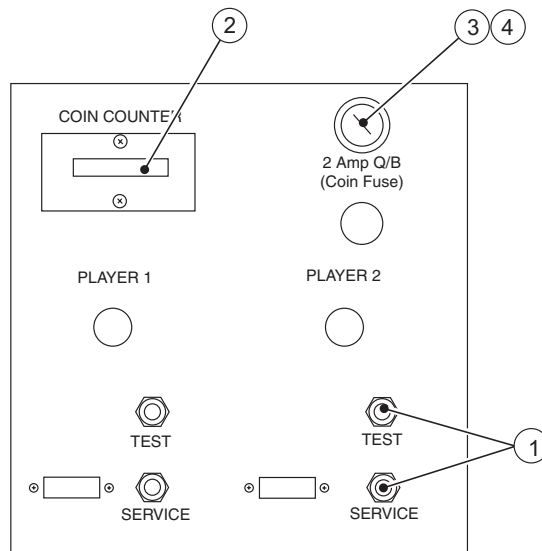

Item	Description	Part No
1	Pushbutton Switch - 7mm Red F424	60000059
2	Panel Mount Meter - 3.5~6v	65000002
3	Fuseholder 20mm Panel Mount	63500786
4	Fuse 20mm 2A Q/B	63500501

9. DISPOSAL OF THE MACHINE

IMPORTANT

- **The machine must be collected, transported and discarded in accordance with the EC Directive 2002/96/EC on Waste Electrical and Electronic Equipment (WEEE) and/or any local laws and regulations.**
- **When entrusting a third party to collect, transport and discard the machine, be sure to use authorised companies to perform those tasks.**

10. SCHEMATIC

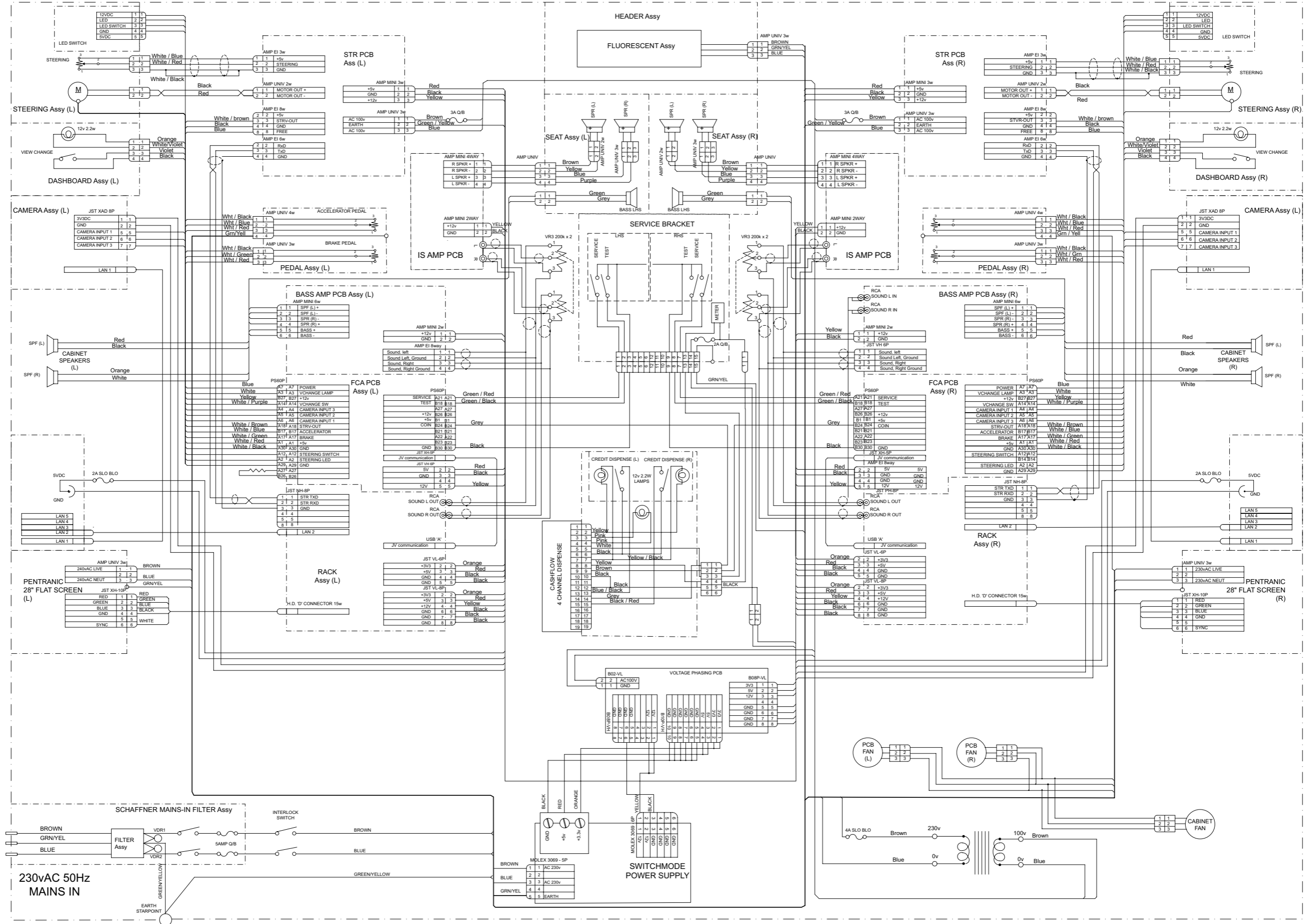

Copies of Namco Game Manuals can be downloaded from our website:
www.namco.co.uk under Components Distribution

For all Parts or Technical Support contact:

Brent Electronic,
Namco House,
Units 7-8, Acton Park Estate,
The Vale,
London. W3 7QE

www.brentelectronic.co.uk

For Technical Support, Warranty and

Advance Replacement Parts:-  +44 (0) 20 8324 6120

For Consumable Parts:-  +44 (0) 20 8324 6102

Fax for both:-  +44 (0) 20 8324 6126