



INSTRUCTION MANUAL

Service #

708-215-5100

Jerry Korbecki ext. 122 Paul Sawicki ext. 123

 **KONAMI**® is a trademark of Konami Industry Co., Ltd.

Punkshot is a registered trademark of Konami, Inc. © 1990 Konami Inc.

PUNKSHOT PARTS LIST

Part #	Description
30119	Green Button
30113	Orange Button
30202	Switch Holder
30250	Palnut
30306	Green Joy Stick
30322	Orange Joy Stick
40355	Monitor Plexi
40601	FCC Cage
963011	DC Harness
907400	Manual
907100	Control Panel Overlay
907200	Marquee
907101	Player Instructions
907300	Upper Right Side Decal
907301	Lower Left Side Decal
907302	Lower Right Side Decal
907303	Upper Left Side Decal
907102	Kit Control Panel Overlay
40904	Kit Harness
821700	19" Monitor Bezel

PUNKSHOT WIRING HARNESS—4 PLAYER VERSION ONLY

WIRE COLOR KEY:		Solder Side ←		→ Parts Side		
BLACK	GND	A	1	GND	BLACK	BLACK
BLACK	GND	B	2	GND	BLACK	BLACK
RED	+5V DC	C	3	+5V DC	RED	RED
RED	+5V DC	D	4	+5V DC	RED	RED
	NOT USED	E	5	NOT USED		
ORANGE	+ 12V DC	F	6	+ 12V DC	ORANGE	ORANGE
	*KEY	H	7	*KEY		
	(EMPTY)	J	8	COIN COUNTER	GREEN/GRAY	GREEN/GRAY
	(EMPTY)	K	9	(EMPTY)		
YELLOW	SPEAKER (-)	L	10	SPEAKER (+)	BLUE	BLUE
	(EMPTY)	M	11	(EMPTY)		
WHITE/GREEN	VIDEO GREEN	N	12	VIDEO RED	RED/WHITE	RED/WHITE
WHITE	VIDEO SYNC	P	13	VIDEO BLUE	BLUE/WHITE	BLUE/WHITE
	(EMPTY)	R	14	VIDEO GROUND	BLACK	BLACK
	(EMPTY)	S	15	(EMPTY)		
VIOLET/WHITE	COIN 2	T	16	COIN 1	BLUE/BROWN	BLUE/BROWN
	NOT USED	U	17	NOT USED		
BLUE/YELLOW	2P UP	V	18	1P UP	ORANGE/WHITE	ORANGE/WHITE
VIOLET/YELLOW	2P DOWN	W	19	1P DOWN	BLACK/WHITE	BLACK/WHITE
ORANGE/GREEN	2P LEFT	X	20	1P LEFT	RED/GRAY	RED/GRAY
ORANGE/YELLOW	2P RIGHT	Y	21	1P RIGHT	GRAY/WHITE	GRAY/WHITE
BLACK/YELLOW	2P PASS	Z	22	1P PASS	RED/WHITE	RED/WHITE
ORANGE/GRAY	2P SHOOT	a	23	1P SHOOT	GREEN/BROWN	GREEN/BROWN
	NOT USED	b	24	NOT USED		
	NOT USED	c	25	NOT USED		
	NOT USED	d	26	NOT USED		
BLACK	GND	e	27	GND	BLACK	BLACK
BLACK	GND	f	28	GND	BLACK	BLACK

(BASE COLOR/LINE COLOR)

2 PLAYER KIT WIRING ON PAGE 9

PUNKSHOT SUB HARNESS FOR 3 PLAYERS & 4 PLAYERS 4 PLAYER VERSION ONLY

CN2 3P CONTROLS	1	Coin 3	White/Violet
	2	Empty	
	3	3P Left	White/Red
	4	3P Right	White/Yellow
	5	3P Up	White/Black
	6	3P Down	White/Blue
	7	3P Pass	White/Brown
	8	3P Shoot	White/Orange
	9	Empty	
	10	Empty	
	11	Empty	
	12	Empty	
	13	Empty	
	14	Empty	
	15	Ground	Black

CN3 4P CONTROLS	1	Coin 4	Blue
	2	Empty	
	3	4P Left	Yellow/Black
	4	4P Right	Brown/Black
	5	4P Up	Green/Yellow
	6	4P Down	Yellow/Red
	7	4P Pass	Yellow/White
	8	4P Shoot	Yellow/Blue
	9	Empty	
	10	Empty	
	11	Empty	
	12	Empty	
	13	Empty	
	14	Empty	
	15	Ground	Black

PUNKSHOT DIP SWITCH SETTINGS

DIP SWITCH NO. 1 SETTINGS

1. COIN SWITCH NO. 1 SETTINGS

SW	1	2	3	4	COIN	CREDIT
○	OFF	OFF	OFF	OFF	1	1
	ON				1	2
	OFF	ON			1	3
	ON				1	4
	OFF	OFF	ON	OFF	1	5
	ON				1	6
	OFF	ON			1	7
	ON				2	1
	OFF	OFF	OFF	ON	2	3
	ON				2	5
	OFF	ON			3	1
	ON				3	2
	OFF	OFF	ON	ON	3	4
	ON				4	1
	OFF	ON			4	3
	ON				5	1

Set No. 5, 6, 7, 8 OFF in Dip Switch No. 1

Put Dip Switch No. 5 to ON to give
"1 coin = CONTINUE."

Notice: For 50¢ Start 25¢ Continue
Set Dip Switch Bank one as shown.

1	2	3	4	5	6	7	8
O	O	O	O	O	O	O	O
N	N	N	F	N	N	N	N
			F				

DIP SWITCH NO. 2 SETTINGS

1. LIFE ENERGY

SW	1	2	LIFE ENERGY
○	OFF	OFF	30
	ON		40
	OFF	ON	50
	ON		60

2. QUARTER TIME

SW	3	4	QUARTER TIME
○	OFF	OFF	2 MINUTES
	ON		3 MINUTES
	OFF	ON	4 MINUTES
	ON		5 MINUTES

3. DIFFICULTY OF THE GAME

SW	6	7	DIFFICULTY
○	OFF	OFF	EASY
	ON		NORMAL
	OFF	ON	DIFFICULT
	ON		VERY DIFFICULT

4. SOUND IN ATTRACTIVE MODE

SW	8	SOUND
○	OFF	OFF
	ON	ON

SW5 are not used.

DIP SWITCH NO. 3 SETTINGS

1. VIDEO SCREEN FLIP

SW	1	SCREEN
○	OFF	NORMAL
	ON	UPSIDE DOWN

2. CHANGE OF MODE

SW	3	MODE
○	OFF	GAME
	ON	TEST

SW2 and SW4 are not used and should be kept OFF.
○ shows recommended settings.

PUNKSHOT: AC FLOW CHART 4 PLAYER DEDICATED UPRIGHT ONLY

- 1. GREEN/YELLOW
- 2. BLACK
- 3. RED
- 4. BLUE
- 5. BROWN
- 6. RED/BLACK
- 7. BLACK/WHITE
- 8. WHITE
- 9. GREEN
- 10. VIOLET
- 11. ORANGE

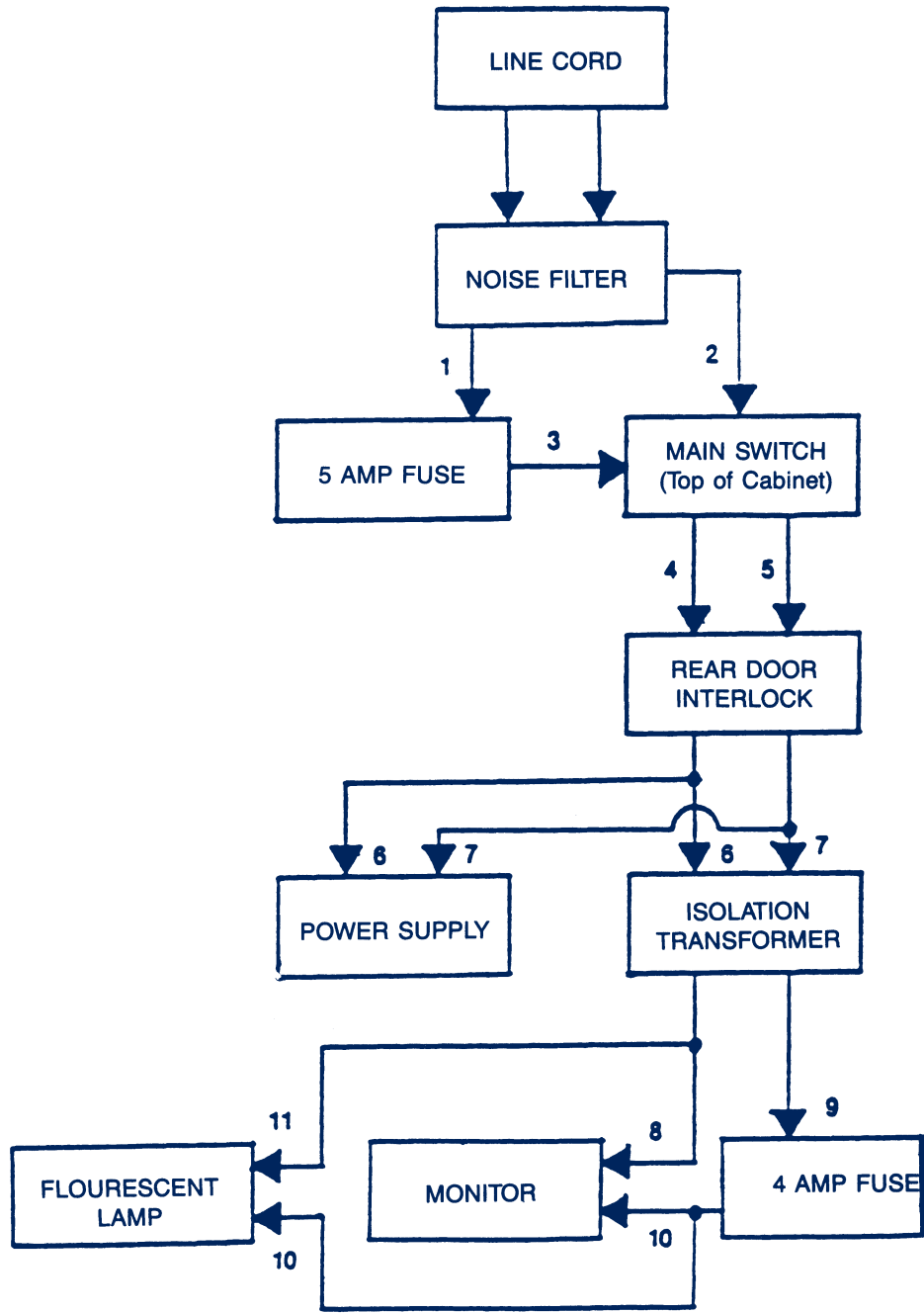

SPEAKER WIRING FOR KITS ONLY

STEREO NOT UTILIZED ON DEDICATED UPRITES

STEREO/MONO SOUND INSTALLATION

Konami introduces stereo sound.

Please read instructions carefully. If your video cabinet doesn't utilize two speakers, follow instructions for mono output.

TECHNICAL INFORMATION

Adjusting Sound Volume

In stereo specifications, adjust volume of each speaker separately (L and R).

In monaural specifications, use R-volume switch to adjust volume. L-volume switch is irrelevant to volume. By R VOLUME.

HOW TO CHANGE TO MONAURAL/STEREO

*Note: Mono & Stereo sound *cannot* operate simultaneously.

For Mono Sound

Use pin #10 and L of the 56 pin edge connector to the speaker contacts.

Also connect Jumper connector into CN4.

For Stereo Sound

Use connector CN6 as your speaker output ports connect pins 1 & 2 to the left speaker pins 3 & 4 to the right speakers.

Also connect Jumper connector to CN5.

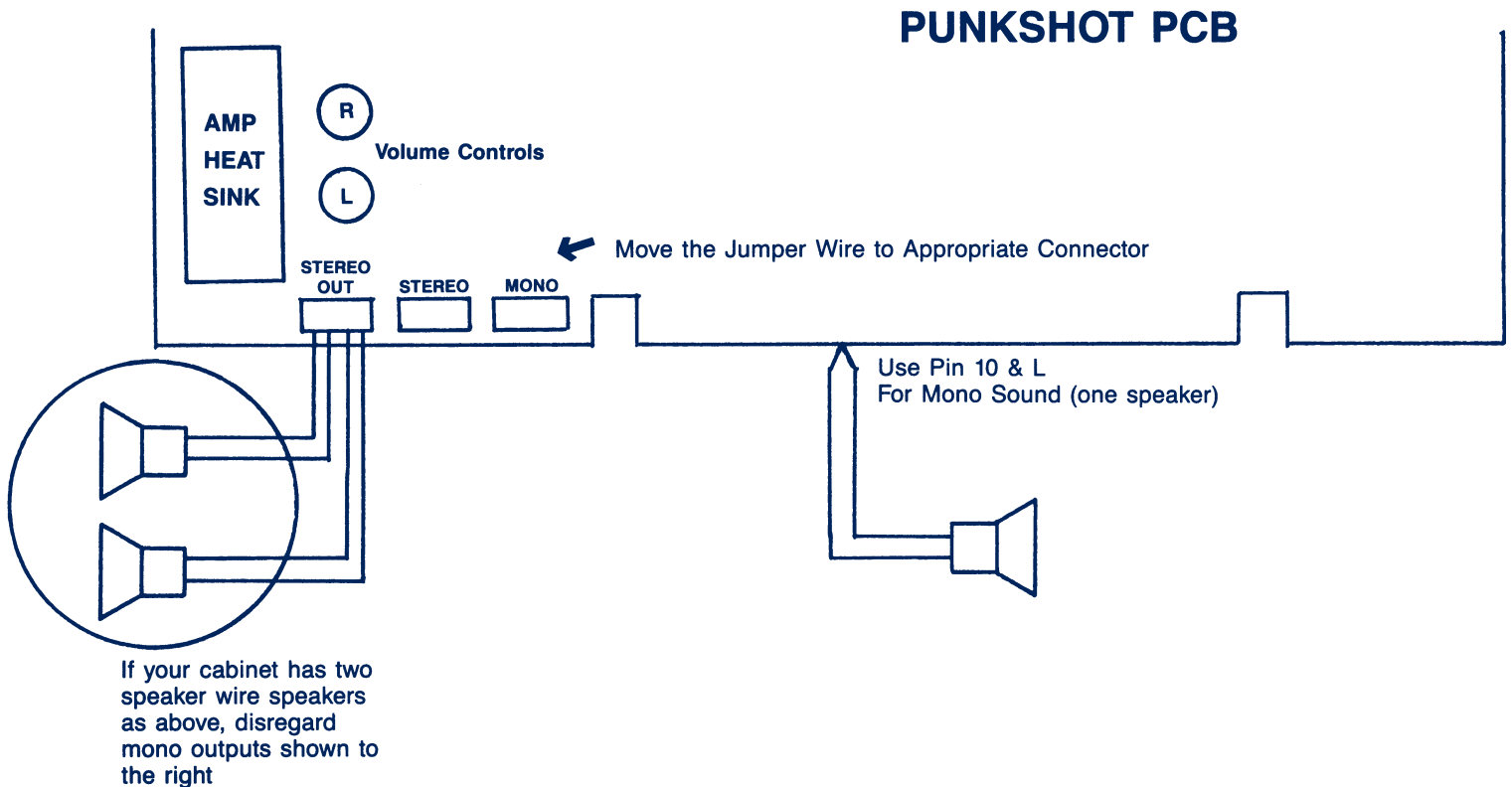

PUNKSHOT WIRING DIAGRAM—2 PLAYER KIT ONLY

WIRE COLOR KEY:		← Solder Side	Parts Side →		
BLACK	GND	A	1	GND	BLACK
BLACK	GND	B	2	GND	BLACK
RED	+5V DC	C	3	+5V DC	RED
RED	+5V DC	D	4	+5V DC	RED
BLUE	NOT USED	E	5	NOT USED	BLUE
ORANGE	+ 12V DC	F	6	+ 12V DC	ORANGE
	*KEY	H	7	*KEY	
WHITE/RED	COIN COUNTER 2	J	8	COIN COUNTER 1	WHITE/BLACK
	(EMPTY)	K	9	(EMPTY)	
RED/BLACK	SPEAKER	L	10	SPEAKER	RED/YELLOW
	(EMPTY)	M	11	(EMPTY)	
GREEN	VIDEO GREEN	N	12	VIDEO RED	RED
WHITE	VIDEO SYNC	P	13	VIDEO BLUE	BLUE
WHITE/ORANGE	SERVICE SW	R	14	VIDEO GROUND	BLACK
BLACK/WHITE	(EMPTY)	S	15	(EMPTY)	WHITE/BROWN
BROWN/BLACK	COIN 2	T	16	COIN 1	YELLOW/BLACK
RED/WHITE	2P START	U	17	1P START	RED
BLUE/WHITE	2P UP	V	18	1P UP	BLUE
GREEN/WHITE	2P DOWN	W	19	1P DOWN	GREEN
ORANGE/WHITE	2P LEFT	X	20	1P LEFT	ORANGE
YELLOW/WHITE	2P RIGHT	Y	21	1P RIGHT	YELLOW
BROWN/WHITE	2P PASS	Z	22	1P PASS	BROWN
VIOLET/WHITE	2P SHOOT	a	23	1P SHOOT	VIOLET
GRAY/WHITE	NOT USED	b	24	NOT USED	GRAY
	NOT USED	c	25	NOT USED	
	NOT USED	d	26	NOT USED	
BLACK	GND	e	27	GND	BLACK
BLACK	GND	f	28	GND	BLACK

(BASE COLOR/LINE COLOR)

PUNKSHOT TECHNICAL INFORMATION

Punkshot requires horizontally mounted monitor. It also generates composite negative sync. If your monitor is composite positive sync, you will have to change to composite negative sync.

To alternate composite positive sync to composite negative sync, use 7404 IC or 74LS04 IC. The signal on the output pin from the P.C.B. is a combination of H-sync and V-sync.

NOTE: Please refer to Figure 2.

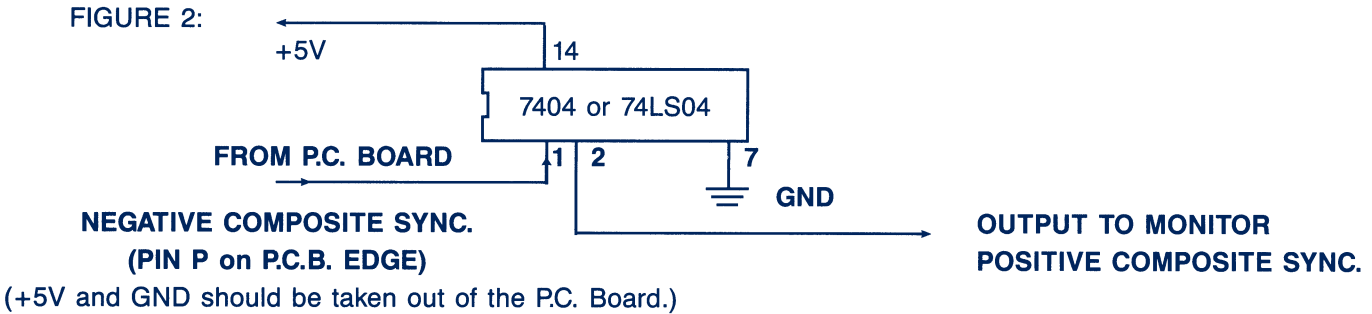

TROUBLE SHOOTING GUIDE

PROBLEM:	POSSIBLE SOLUTION
No Screen or Constant Reset	<ol style="list-style-type: none"> 1). Check +5V line at the P.C.B. Adjust if necessary. 2). Make sure all socketed eproms and custom IC's are seated securely. Apply light pressure to secure. 3). Check harness to be sure it is not on backwards.
No Sound	<ol style="list-style-type: none"> 1). Check +12V line at the P.C.B. 2). Make sure both speaker out wires are connected to the speakers. (DO NOT CONNECT A GROUND.)
Distorted Sound	<ol style="list-style-type: none"> 1). Replace cabinet speaker.
I/O Problem (coin 1 doesn't work or Joystick Up doesn't work, etc.)	<ol style="list-style-type: none"> 1). Do not hook a coin counter to the coin 1 or coin 2 outputs. This will cause damage. 2). Check your schematic for the 74LS253 IC that corresponds to your I/O problem. Check the appropriate pin with a scope or multimeter for a high output (5V), if output is low replace the 74LS253.

CAUTION

DO NOT WIRE COIN COUNTERS TO THE COIN 1 OR COIN 2 OUTPUTS. THIS WILL CAUSE DAMAGE TO THE I/O MICROCHIP 74LS253. COIN COUNTERS CAN ONLY BE WIRED TO COIN COUNTER OUTPUTS.

PUNKSHOT 2 PLAYER KIT INFORMATION

TECHNICAL INFORMATION

- (1) Required power capacity
GND-Vcc 5V 4A or more
GND-(+12V)
*See the Wiring Diagram.
- (2) Output
R (red) analog, positive
G (green) analog, positive
B (blue) analog, positive
SYNC. H-V complexed, negative
- (3) The monitor should be horizontally installed.
- (4) Use the volume knob on the PCB to adjust sound level.
Turn the knob clockwise and it becomes louder.
- (5) Handle with care.

RECOMMENDED CONTROL PANEL LAYOUT

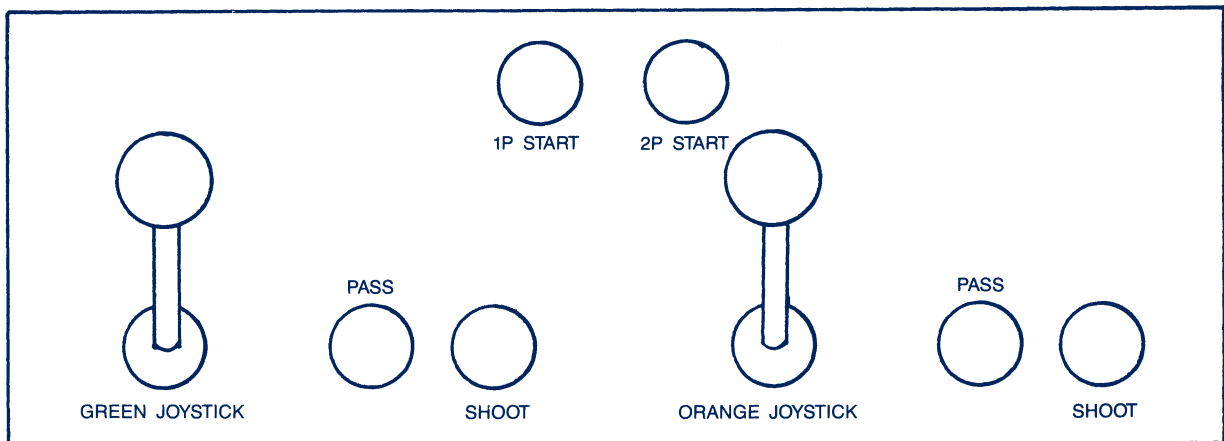

CONTROL PANEL DRILLING TEMPLATE

Button Hole Size 1-3/16 Inch

Use this Template for Player 1 and Player 2 Controls



JOYSTICK

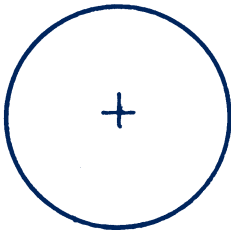

SHOOT 1

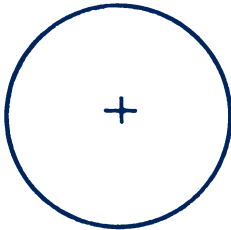

SHOOT 2

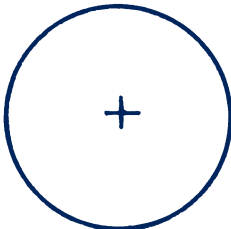

USER INFORMATION WARNING

F.C.C. Regulations requires user to attach the F.C.C. warning label on the back of your video game cabinet.

THIS EQUIPMENT COMPLIES WITH THE REQUIREMENTS IN PART 15 OF FCC RULES FOR A CLASS A COMPUTING DEVICE. OPERATION OF THIS EQUIPMENT IN A RESIDENTIAL AREA MAY CAUSE UNACCEPTABLE INTERFERENCE TO RADIO AND TV RECEPTION REQUIRING THE OPERATOR TO TAKE WHATEVER STEPS ARE NECESSARY TO CORRECT THE INTERFERENCE. THIS DEVICE MUST ACCEPT ANY INTERFERENCE RECEIVED, INCLUDING INTERFERENCE THAT MAY CAUSE UNDESIRE OPERATION.



900 Deerfield Parkway, Buffalo Grove, Illinois 60089-4510
Telephone (708) 215-5100
FAX (708) 215-5122

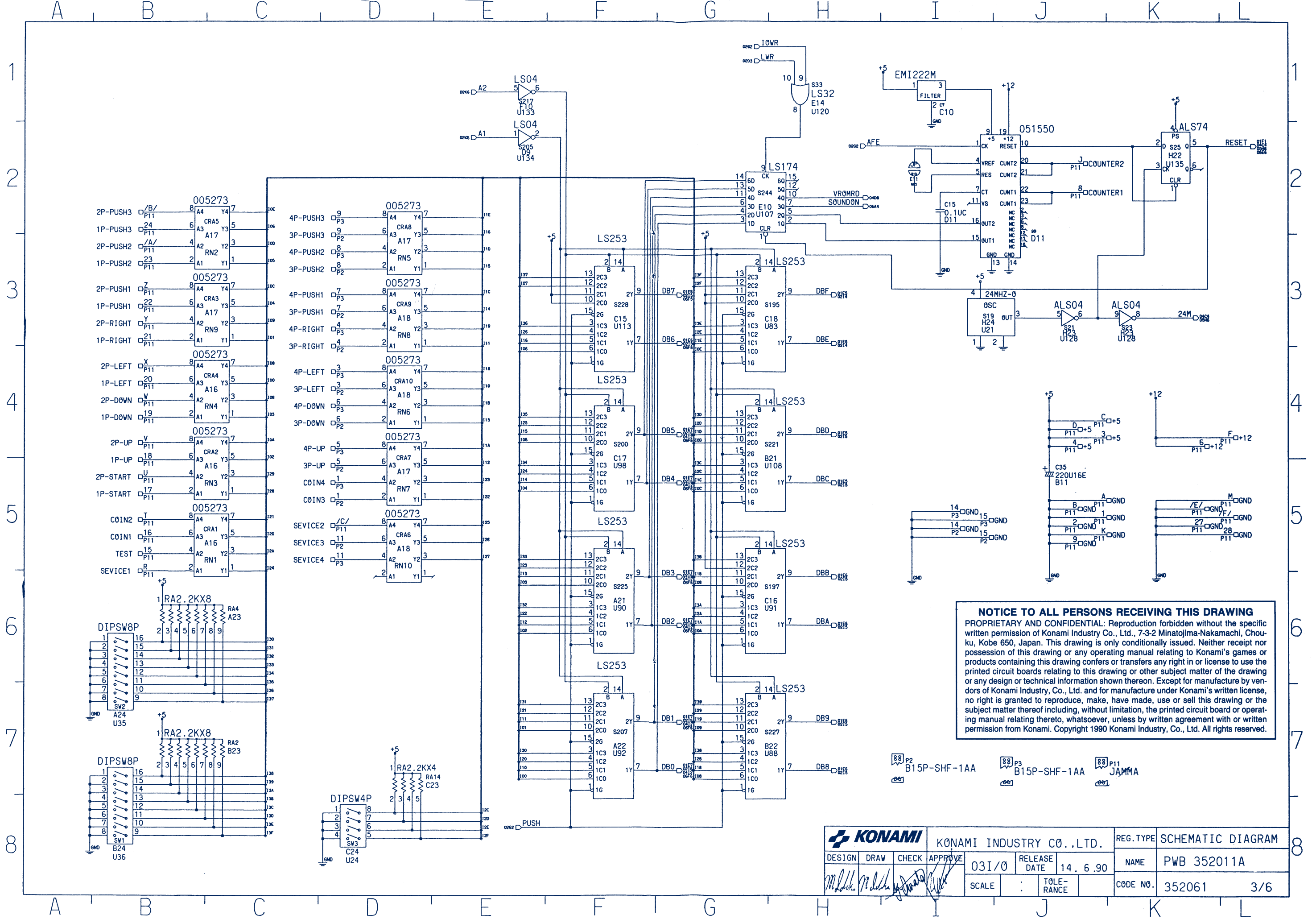

NOTICE TO ALL PERSONS RECEIVING THIS DRAWING
 PROPRIETARY AND CONFIDENTIAL: Reproduction forbidden without the specific written permission of Konami Industry Co., Ltd., 7-3-2 Minatojima-Nakamachi, Chou-ku, Kobe 650, Japan. This drawing is only conditionally issued. Neither receipt nor possession of this drawing or any operating manual relating to Konami's games or products containing this drawing confers or transfers any right in or license to use the printed circuit boards relating to this drawing or other subject matter of the drawing or any design or technical information shown thereon. Except for manufacture by vendors of Konami Industry, Co., Ltd. and for manufacture under Konami's written license, no right is granted to reproduce, make, have made, use or sell this drawing or the subject matter thereof including, without limitation, the printed circuit board or operating manual relating thereto, whatsoever, unless by written agreement with or written permission from Konami. Copyright 1990 Konami Industry, Co., Ltd. All rights reserved.

88 P2 B15P-SHF-1AA
 88 P3 B15P-SHF-1AA
 88 P11 JAMMA

KONAMI				KONAMI INDUSTRY CO., LTD.		REG. TYPE	SCHMATIC DIAGRAM
DESIGN	DRAW	CHECK	APPROVE	RELEASE DATE	14. 6. 90	NAME	PWB 352011A
			SCALE	TOLE-RANCE		CODE NO.	352061 3/6

WIRING DIAGRAM

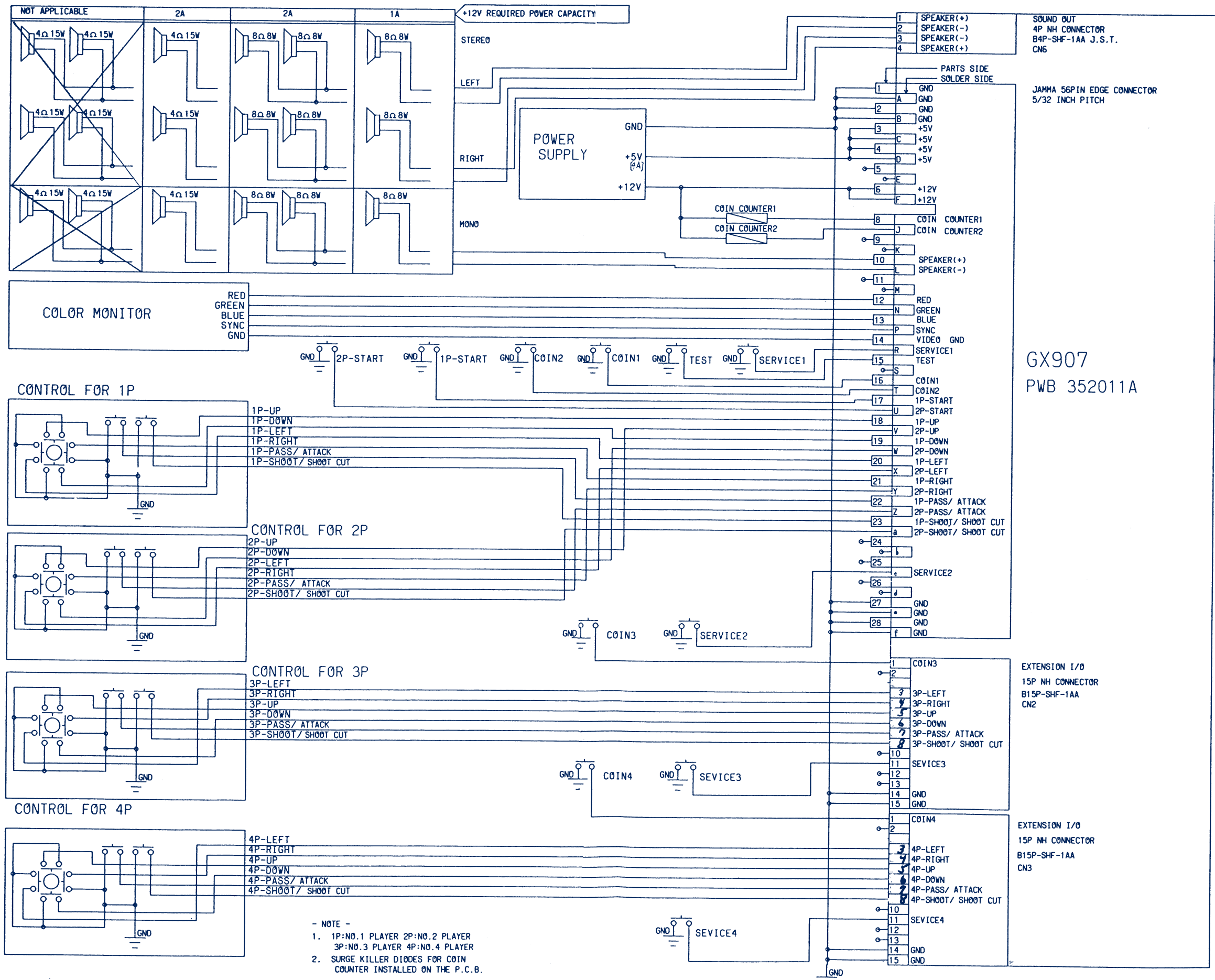

WARNING!
THIS DOCUMENT CONTAINS INFORMATION PROPRIETARY TO KONAMI INDUSTRY CO.,LTD.(KONAMI). USE OR DISCLOSURE WITHOUT THE WRITTEN PERMISSION OF AN OFFICER OF KONAMI IS EXPRESSLY FORBIDDEN.
COPYRIGHT © KONAMI 1990