



Universal Kit Kit Installation Instructions & Service Manual

SEGA AMUSEMENTS U.S.A., INC.

800 ARTHUR AVENUE, ELK GROVE VILLAGE, IL 60007-5215
Phone: 888-877-2669 Facsimile: 847-427-1065
WEB: WWW.SAU.SEGA.COM

© SEGA

All manufacturers, cars, names, brands and associated imagery featured in this game are trademarks and/or copyrighted materials of their respective owners. All rights reserved.

IMPORTANT

- Before using this product, read this manual carefully to understand the contents herein stated.
- After reading this manual, be sure to keep it near the product or in a convenient place for easy reference when necessary.

BEFORE USING THE PRODUCT, BE SURE TO READ THE FOLLOWING:

To maintain safety:

To ensure the safe operation of this product, be sure to read the following before usage. The following instructions are intended for the users, operators and the personnel in charge of the operation of the product. After carefully reading and sufficiently understanding the warning displays and cautions, handle the product appropriately. Be sure to keep this manual close to the product or in a convenient place for future reference.

Herein, explanations which require special attention are enclosed with dual lines. Depending on the potentially hazardous degrees, the terms of DANGER, WARNING, CAUTION, etc. are used. Be sure to understand the contents of the displays before reading the text.



Indicates that mishandling the product by disregarding this pictograph will cause severe injury or death.



Indicates that mishandling the product by disregarding this caution will cause a slight hazardous situation which can result in personal injury and/or material damage.



Indicates that mishandling the product by disregarding this warning will cause a potentially hazardous situation which can result in death or serious injury.

For the safe usage of the product, the following pictographs are used:



Indicates "HANDLE WITH CARE." In order to protect the human body and equipment, this display is attached to places where the Owner's Manual, Serviceman Manual and/or Service Manual should be referred to.



Indicates a "Protective Earth Terminal." Before operating the equipment, be sure to connect it to the Ground.
(The step may be omitted for products in which a power cord with earth is used.)

- **Perform work in accordance with the instructions herein stated.**
Instructions for work are explained by paying attention to the aspect of accident prevention. Failing to perform work as per the instructions can cause accidents. In the case where only those who have technical expertise should perform the work to avoid hazardous situation, the instructions herein state that the site maintenance personnel should perform such work.
- **Be sure to turn off the power before working on the machine.**
To prevent an electric shock, be sure to turn off the power before carrying out any work that requires direct contact with the interior of the product. If the work is to be performed in the power-on status, the Instruction Manual herein always states to that effect.
- **Be sure to ground the Earth Terminal.**
(This is not required in the case where a power cord with earth is used.)
This product is equipped with the Earth Terminal. When installing the product, connect the Earth Terminal to the "accurately grounded indoor earth terminal" by using an earth wire. Unless the product is grounded appropriately, the user can be subject to an electric shock. After performing repair, etc. for the control equipment, ensure that the Earth Wire is firmly connected to the control equipment.
- **Ensure that the Power Supply used is equipped with an Earth Leakage Breaker.**
This product does not incorporate the Earth Leakage Breaker. Using a power supply which is not equipped with the Earth Leakage Breaker can cause a fire when earth leakage occurs.
- **Be sure to use fuses which meet the specified rating.**
(Only for the machines which use fuses.)
Using fuses exceeding the specified rating can cause a fire and an electric shock.

- **Specification changes (removal of equipment, conversion and addition) not designated by SEGA are not allowed.**

The parts of the product include warning labels for safety, covers for personal protection, etc. It is very hazardous to operate the product by removing parts and/or modifying the circuits. Should doors, lids and protective parts be damaged or lost, refrain from operating the product, and contact where the product was purchased from or the office herein stated.

SEGA shall not be held responsible for any accidents, compensation for damage to a third party, resulting from the specifications not designated by SEGA.

- **Ensure that the product meets the requirements of appropriate Electrical Specifications.**

Before installing the product, check for Electrical Specifications. SEGA products have a nameplate on which Electrical Specifications are described. Ensure that the product is compatible with the power supply voltage and frequency requirements of the location. Using any Electrical Specifications different from the designated Specifications can cause a fire and an electric shock.

- **Install and operate the product in places where appropriate lighting is available, allowing warning labels to be clearly read.**

To ensure safety for the customers, labels and printed instructions describing potentially hazardous situations are applied to places where accidents can be caused. Ensure that where the product is operated has sufficient lighting allowing the warnings to be read. If any label is peeled off, apply it again immediately. Please place an order with where the product was purchased from or the office herein stated.

- **When handling the monitor, be very careful. (Applies only to the product with a monitor.)**

Some of the monitor (TV) parts are subject to high tension voltage. Even after turning off the power, some portions are still subject to high tension voltage sometimes. Monitor repair and replacement should be performed only by those technical personnel who have knowledge of electricity and technical expertise.

- **Be sure to adjust the monitor/projector properly. (Applies only to the product with a monitor/projector.)**

Do not operate the product leaving on-screen flickering or blurring as it is. Using the product with the monitor/projector not properly adjusted may cause dizziness or a headache to an operator, a player, or the customers.

- **When transporting or reselling this product, be sure to attach this manual to the product.**

In the case where commercially available monitors and printers are used in this product, only the contents relating to this product are explained herein. Some commercially available equipment has functions and reactions not stated in this manual. Read this manual together with the specific Instruction Manual of such equipment.

**Descriptions herein contained may be subject to improvement changes without notice.*

**The contents described herein are fully prepared with due care. However, should any question arise or errors be found, please contact SEGA.*

INSPECTIONS IMMEDIATELY AFTER TRANSPORTING THE PRODUCT TO THE LOCATION

Normally, at the time of shipment, SEGA products are in a status allowing for usage immediately after transporting to the location. Nevertheless, an irregular situation may occur during transportation. Before turning on the power, check the following points to ensure that the product has been transported in a satisfactory status.

- Are there any dented portions or defects (cuts, etc.) on the external surfaces of the cabinet?
- Are Casters and Adjusters damaged?
- Do the power supply voltage and frequency requirements meet with those of the location?
- Are all wiring connectors correctly and securely connected? Unless connected in the correct way, connector connections can not be made accurately. Do not insert connectors forcibly.
- Do power cords have cuts and dents?
- Do the fuses used meet specified ratings? Is the Circuit Protector in an energized status?
- Are all accessories available?
- Can all Doors and Lids be opened with the Accessory Keys? Can Doors and Lids be firmly closed?

TABLE OF CONTENTS

BEFORE USING THE PRODUCT, BE SURE TO READ THE FOLLOWING:

TABLE OF CONTENTS	i
INTRODUCTION	iv
1 HANDLING PRECAUTIONS	1
2 PRECAUTIONS REGARDING INSTALLATION LOCATION	3
2-1 LIMITATIONS OF USAGE	4
3 PRECAUTIONS REGARDING PRODUCT OPERATION	4
4 PART DESCRIPTIONS	6
8 ACCESSORIES	8
6 ASSEMBLY AND INSTALLATION	9
6-1 INSTALLATION	11
6-2 TURNING ON THE POWER (SOFTWARE INSTALLATION)	13
6-3 CHECKING ASSEMBLY (SETUP)	14
7 PRECAUTIONS WHEN MOVING THE MACHINE	16
8 GAME DESCRIPTION	17
8-1 GAME OUTLINE.....	17
8-2 GAME MODE.....	18
8-3 BONUS SHOTS.....	19
8-4 NUMBER OF PLAYERS.....	20
8-5 GAME FLOW.....	21

9 SYSTEM MENU 22

 9-1 SWITCH UNIT AND COIN METER23

 9-2 SYSTEM MENU24

 9-3 TEST MODE25

 9-4 CONFIGURATION31

 9-5 BOOKKEEPING36

 9-6 BACKUP CLEAR39

10 PERIODIC INSPECTION 42

11 TROUBLESHOOTING 43

 11-1 TROUBLESHOOTING (WHEN NO ERROR MESSAGE IS SHOWN).....43

 11-2 ERROR MESSAGES44

12 GAME BOARD 45

13 CABINET PARTS DESCRIPTION 51

14 PARTS LIST, CONTROLLER 52

15 WIRE COLOR CODE TABLE 53

16 WIRING DIAGRAM 54

17 LINCENSE MARK..... 57

INTRODUCTION

This manual is intended to provide detailed descriptions together with all the necessary information covering the general operation of electronic assemblies, electro-mechanicals, servicing control, spare parts, etc. for the product, "SEGA CLAY SHOOTING, CVT KIT".

This manual is intended for the owners, personnel and managers in charge of operation of the product. Operate the product after carefully reading and sufficiently understanding the instructions.

In the unlikely event that the product does not function correctly, DO NOT allow anyone other than a technician to touch the internal system. Turn off the power to the machine, making sure to unplug the electrical cord from the outlet, and contact the office listed below or the point of purchase for this product.

Use of this product is unlikely to cause physical injuries or damage to property. However, points that require special attention are indicated by bold text, the word "IMPORTANT" and the symbol below.



Indicates important information that, if ignored, may result in the mishandling of the product and cause faulty operation or damage to the product.

Sega Amusements U.S.A., Inc.

800 Arthur Avenue, Elk Grove Village, IL 60007-5215, U.S.A.

TEL: 1-847-364-9787

TOLL FREE: 1-888-877-2669

FAX: 1-847-427-1065

Definition of 'Site Maintenance Personnel or Other Qualified Individuals'

WARNING

Procedures not described in this manual or marked as 'to be carried out by site maintenance personnel or other qualified professionals' should not be carried out by personnel without the necessary skill or technology. Work carried out by unqualified persons may cause serious accidents, including electrocution.

Parts replacement, maintenance inspections and troubleshooting should be carried out by site maintenance personnel or other qualified professionals. This manual includes directions for potentially dangerous procedures which should only be carried out by professionals with the appropriate specialized knowledge.

The site maintenance personnel or other qualified professionals mentioned in this manual are defined as follows:

Site maintenance personnel:

Individuals with experience in maintaining amusement equipment, vending machines, etc., working under the supervision of the owner/operator of this product to maintain machines within amusement facilities or similar premises by carrying out everyday procedures such as assembly, maintenance inspections, and replacement of units/expendable parts.

Activities to be carried out by site maintenance personnel:

Amusement equipment/vending machine assembly, maintenance inspection and replacement of units/expendable parts.

Other qualified professionals:

Persons employed by amusement equipment manufacturers, or involved in design, production, testing or maintenance of amusement equipment. The individual should have either graduated from technical school or hold similar qualifications in electrical/electronics/mechanical engineering.

Activities to be carried out by other qualified professionals:

Amusement equipment/vending machine assembly, repair/adjustment of electrical/electronic/mechanical parts.

1 HANDLING PRECAUTIONS

When installing or inspecting the machine, be very careful of the following points and pay attention to ensure that the player can enjoy the game safely.

Non-compliance with the following points or inappropriate handling running counter to the cautionary matters herein stated can cause personal injury or damage to the machine.

⚠ WARNING

- **Before performing work, be sure to turn the power off. Performing the work without turning the power off can cause an electric shock or short circuit. In the case work should be performed in the status of power on, this manual always states to that effect.**
- **To avoid an electric shock or short circuit, do not plug in or unplug quickly.**
- **To avoid an electric shock, do not plug in or unplug with a wet hand.**
- **Do not expose power cords or earth wires on the surface, (floor, passage, etc.). If exposed, the power cords and earth wires are susceptible to damage. Damaged cords and wires can cause an electric shock or short circuit.**
- **To avoid causing a fire or an electric shock, do not put things on or damage the power cords.**
- **When or after installing the product, do not unnecessarily pull the power cord. If damaged, the power cord can cause a fire or an electric shock.**
- **In case the power cord is damaged, ask for a replacement through where the product was purchased from or the office herein stated. Using the cord as is damaged can cause fire, an electric shock or leakage.**
- **Be sure to perform grounding appropriately. Inappropriate grounding can cause an electric shock.**
- **Be sure to use fuses meeting the specified rating. Using fuses other than the specified rating can cause a fire or an electric shock.**
- **Be sure that connections such as IC BD are made properly. Insufficient insertion can cause an electric shock.**
- **Specification changes, removal of equipment, conversion and/or addition, not designated by SEGA are not permitted.**
 - **Failure to observe this may cause a fire or an electric shock. Non-compliance with this instruction can have a bad influence upon physical conditions of the players or the onlookers, or result in injury during play.**
 - **SEGA shall not be held responsible for damage, compensation for damage to a third party, caused by specification changes not designated by SEGA.**
- **Do not perform any work or change parts not listed in this manual. Doing so may lead to an accident.**

If you need to perform any work not listed in this manual, request work from the office indicated in this manual or the point of purchase, or inquires for details.
- **Be sure to perform periodic maintenance inspections herein stated.**

STOP IMPORTANT

- For the IC board circuit inspections, only the logic tester is allowed. The use of a multiple-purpose tester is not permitted, so be careful in this regard.
- When cleaning the CRT surfaces, use a soft and dry cloth. Do not apply chemicals such as thinner, benzene, etc.
- Static electricity from your body may damage some electronics devices on the IC board. Before handling the IC board, touch a grounded metallic surface so that the static electricity can be discharged.
- Some parts are not designed and manufactured specifically for this game machine. The manufacturers may discontinue, or change the specifications of such general-purpose parts. If this is the case, SEGA cannot repair or replace a failed game machine whether or not a warranty period has expired.

2 PRECAUTIONS REGARDING INSTALLATION LOCATION

⚠️ WARNING

This product is an indoor game machine. Do not install it outside. Even indoors, avoid installing in places mentioned below so as not to cause a fire, electric shock, injury and/or malfunction.

- Places subject to rain or water leakage, or places subject to high humidity in the proximity of an indoor swimming pool and/or shower, etc.
- Places subject to direct sunlight, or places subject to high temperatures in the proximity of heating units, etc.
- Places filled with inflammable gas or vicinity of highly inflammable/volatile chemicals or hazardous matter.
- Dusty places.
- Sloped surfaces.
- Places subject to any type of violent impact.
- Vicinity of anti-disaster facilities such as fire exits and fire extinguishers.
- Areas where the temperature exceeds the applicable temperature (ambient temperature) range of 5 to 30 degrees centigrade.

2-1 LIMITATIONS OF USAGE

⚠️ WARNING

- Be sure to check the Electrical Specifications. Ensure that this product is compatible with the location's power supply, voltage, and frequency requirements. A plate describing Electrical Specifications is attached to the product. Non-compliance with the Electrical Specifications can cause a fire and electric shock.
- This product requires a breaker and earth mechanism as part of the location facilities. Using the product without these can cause a fire and electric shock.
- Ensure that the indoor wiring for the power supply is rated at 15 A or higher (AC single phase 100 V ~ 120 V area). Non-compliance with the Electrical Specifications can cause a fire and electric shock.
- Be sure to use an independent power supply equipped with an earth leakage breaker. Using a power supply without an earth leakage breaker can cause an outbreak of fire if a power surge occurs.
- Putting many loads on one electrical outlet can cause generation of heat and a fire resulting from overload.
- When using an extension cord, ensure that the cord is rated at 15 A or higher (AC 100 V ~ 120 V area). Using a cord rated lower than the specified rating can cause a fire and electric shock.

3 PRECAUTIONS REGARDING PRODUCT OPERATION

To avoid injury and trouble, be sure to pay attention to the behavior of visitors and players.

BEFORE OPERATION

⚠ WARNING

In order to avoid accidents, check the following before starting the operation:

- To ensure maximum safety for the players and the customers, ensure that where the product is operated has sufficient lighting to allow any warnings to be read. Operation under insufficient lighting can cause bodily contact with each other, hitting accident, and/or trouble between customers.
- Be sure to perform appropriate adjustment of the monitor (projector). For operation of this machine, do not leave monitor's flickering or deviation as is. Failure to observe this can have a bad influence upon the players' or the customers' physical conditions.
- It is suggested to ensure a space allowing the players who feel sick while playing the game to take a rest.
- Check if all of the adjusters are in contact with the surface. If they are not, the Cabinet can move and cause an accident.

⚠ WARNING

- Do not put any heavy item on this product. Placing any heavy item on the product can cause a falling down accident or parts damage.
- Do not climb on the product. Climbing on the product can cause falling down accidents. To check the top portion of the product, use a step ladder.
- To avoid electric shock, check to see if door & cover parts are damaged or omitted.
- To avoid electric shock, short circuit and/or parts damage, do not put the following items on or in the periphery of the product. Flower vases, flowerpots, cups, water tanks, cosmetics, and receptacles/containers/vessels containing chemicals and water.

⚠ CAUTION

- During daily cleaning, be sure to check the surface of the steering wheel, gear shifter, and other parts that the player touches with his hands for damage, cracks, or loose screws. If a player uses the machine while it is damaged, cracked, or has a loose screw, the player may become injured.
- During daily cleaning, be sure to check the seat for any abnormality, wetness, etc. Failure to do this may result in deliberate tampering or negligence being left undetected.
- To avoid injury, be sure to provide sufficient space by considering the potentially crowded situation at the installation location. Insufficient installation space can cause making bodily contact with each other, hitting accidents, and/or trouble between customers.

DURING OPERATION (PAYING ATTENTION TO CUSTOMERS)

WARNING

- For safety reasons, do not allow any of the following people to play the game.
 - Those who need assistance such as the use of an apparatus when walking.
 - Those who have high blood pressure or a heart problem.
 - Those who have experienced muscle convulsion or loss of consciousness when playing video games, etc.
 - Those who have neck or spinal cord problems.
 - Those who are intoxicated or under the influence of drugs.
 - Pregnant women.
 - Persons susceptible to motion sickness.
 - Persons who disregard the product's warning displays.
- Even players who have never been adversely affected by light stimulus might experience dizziness or headache depending on their physical condition when playing the game. Small children are especially likely to experience these symptoms. Caution guardians of small children to keep watch on their children during play.
- Instruct those who feel sick during play to have a medical examination.
- To avoid injury from falls and electric shocks due to spilled drinks, instruct the player not to place heavy items or drinks on the product.
- To avoid electric shocks and short circuits, do not allow customers to put hands and fingers or extraneous matter in the openings of the product or small openings in or around the doors.
- To avoid falls and resulting injury, immediately stop the customer from leaning against or climbing on the product, etc.
- To avoid electric shock and short circuit, do not allow customers to unplug the power plug without a justifiable reason.

CAUTION

Immediately stop such violent acts as hitting and kicking the product. Such violent acts can cause parts damage or falling down, resulting in injury due to fragments and falling down.

4 PART DESCRIPTIONS

SEGA CLAY SHOOTING, FULL KIT

KIT Part#: 551-00-003

Main PCB, AW
Part#: 99-10-011

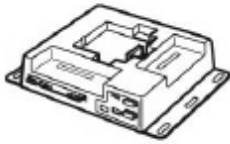

EX I/O Cartridge
Part#: 99-20-005



ASSY ROM CTRG CLAY
Part#: 610-0752P + 551-30-211



28" Shotgun w/Speaker Assy (2 pcs)
Part#: 99-50-324



Marquee CLAY SHOOTING
Part#: 551-30-100



SOUND BD GUN
Part#: 837-14593P



Epilepsy Caution Sticker
Part#: 99-30-014



Instruction AW25UR, CS
Part#: 551-30-210



Gun Holster, Hook (4 pcs)
(w/4 Screws, Nuts & Washers)
Part#: 43-50-303



New Gun Sub Harness (KIT)
Part#: 99-60-685



START Button 2" Yellow Round (2)
Part#: 99-50-006



Overlay, AW KIT
Part#: 99-30-151

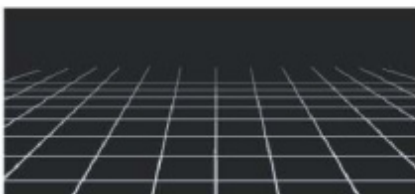

Manual, Clay Shooting
Part#: 551-30-300

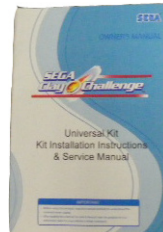

SEGA CLAY SHOOTING, UPDATE KIT without GUNS

KIT Part#: 515-00-077

ASSY ROM CTRG CS
Part#: 610-0752P +
551-30-211



Instruction AW25UR, CS
Part#: 551-30-210



Manual, Clay Shooting
Part#: 551-30-300



Marquee CLAY SHOOTING
Part#: 551-30-100



Epilepsy Caution Sticker
Part#: 99-30-014



5 ACCESSORIES

Confirm that the accessories listed in the table below are present when setting up the product. Accessories marked “Spare” in the note column are consumable items but included as spares.

OWNER'S MANUAL
XXX-30-300 (1)
This manual

6 ASSEMBLY AND INSTALLATION

⚠️ WARNING

- Perform assembly work by following the procedure herein stated. Failure to comply with the instructions can cause electric shock.
- Perform assembling as per this manual. Since this is a complex machine, incorrect assembling can cause an electric shock, machine damage and/or improper functioning as per specified performance.
- When assembling, more than one person is required. Depending on the assembly work, there are some cases in which working by one person alone can cause personal injury or parts damage.
- Ensure that connectors are properly connected. Improper connections can cause electric shock.
- This work should be carried out by the site maintenance personnel or other qualified professionals. Work performed by non-technical personnel can cause a severe accident such as electric shock. Failing to comply with this instruction can cause a severe accident such as electric shock to the player during operation. If no one with proper technological expertise is available, request service from the office indicated in this document or the point of purchase so as to ensure safety.
- Provide sufficient space so that assembling can be performed. Performing work in places with narrow space or low ceiling may cause an accident and assembly work to be difficult.
- To perform work safely and avoid serious accident such as the cabinet falling down, do not perform work in places where step-like grade differences, a ditch, or slope exist.
- Be careful not to damage the wires. Damaged wires may cause electric shock or short circuit or present a risk of fire.
- Do not leave power cords, ground wires, or network cables exposed in areas of heavy foot traffic. Doing so may cause them to become damaged, possibly resulting in electric shock and/or short circuits. When laying wiring across the floor, always use safety covers to protect the wires.
- The power cord for this product has a ground terminal. Make sure to use this ground terminal when plugging it in to an indoor outlet. Failure to properly ground the product could lead to electrocution. It can also lead to malfunction.

⚠ CAUTION

- When opening/closing, attaching/removing doors or lids, be careful that your hand or finger does not get caught in anything.
- To perform the operation safely and accurately you must use a safe, steady footstool or stepladder. Working without this may lead to a fall and possible injury.
- Wear appropriate work clothing so that work can be performed safely. Use gloves and safety shoes to prevent accidents or injuries.
- When installing a wire protection cover over a floor, use a material shaped so that no one passing by will stumble over it. Using a material that could be stumbled over might lead to an accidental fall.
- Handle plastic parts with care. Excessive weight or pressure may cause them to break and the broken pieces may cause injury.

6-1 INSTALLATION

3 kinds as below.

FULL KIT

Atomiswave Main PCB included. This KIT will be able to install to Basic CRT monitor UR cabinets with JAMMA connector on Main harness.

Installation:

- 1) Place New Overlay. Mount 28"Shotgun Assy (2), SOUND BD(1), START PUSH BUTTON (2) GUN HOLSTER (2 sets) and harnesses to your cabinet.
- 2) Place NEW MARQUEE and INSTRUCTION.
- 3) Remove current GAME BOARDS from cabinet. Place ATOMISWAVE MAIN PCB with EX I/O CARTRIDGE and GAME ROM CARTRIDGE.

UPDATE KIT WITH GUNS

Your cabinet must have ATOMISWAVE MAIN PCB and EX I/O CARTRIDGE in the cabinet. .

Installation:

- 1) Place New Overlay. Mount 28"Shotgun Assy (2), SOUND BD(1), START PUSH BUTTON (2) GUN HOLSTER (2 sets) and harnesses to your cabinet.
- 2) Place NEW MARQUEE and INSTRUCTION.
- 3) Remove current GAME CARTRIDGE from ATOMISWAVE MAIN PCB. Make sure EX I/O CARTRIDGE on there.

UPDATE KIT WITHOUT GUNS

Your cabinet must have ATOMISWAVE MAIN PCB, EX I/O CARTRIDGE and 28"Shotgun Assy (2) in your cabinet.

Installation:

- 1) Place NEW MARQUEE and INSTRUCTION.
- 3) Remove current GAME CARTRIDGE from ATOMISWAVE MAIN PCB. Make sure EX I/O CARTRIDGE on there.

Example of cabinet overview



6-2 TURNING ON THE POWER

⚠ WARNING

- The following explanation assumes that the product has been assembled properly as explained above. If there is an error or if the product operates in a manner other than as indicated below, cut off the power supply immediately. Failure to do so may result in a fire or electrical shock.

- 1 Turn the main power switch on to power up.
- 2 The monitor will display an advertize screen.
- 3 The Marquee panel and push buttons will light up. (Depends of cabinet type)
- 4 The sound will be output from both left and right speakers on the cabinet.

6-3 CHECKING ASSEMBLY (SETUP)

Checking Assembly

In the TEST MODE, ensure that the assembly has been made correctly and the connecting board, and input and output device are satisfactory. (Refer to 9-3 “TEST MODE”)

(1) COLOR TEST

In the TEST mode menu, selecting COLOR TEST allows the screen (on which the monitor is tested) to be displayed. Adjust the monitor, if it is necessary.



(2) CROSS HATCH

In the TEST mode menu, selecting CROSS HATCH allows the screen (on which the monitor is sized) to be displayed. Adjust the monitor, if it is necessary.

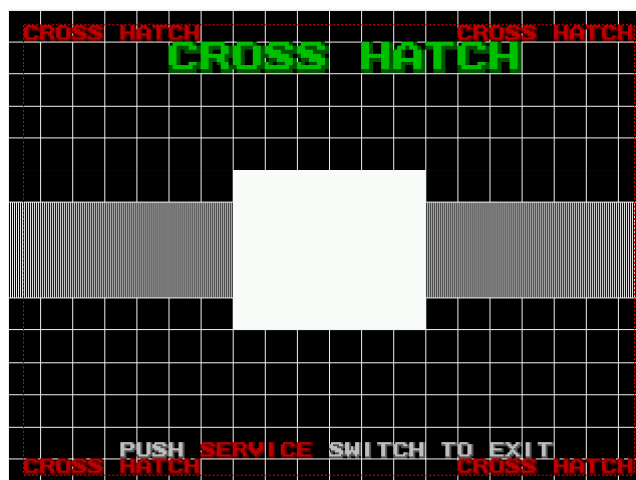

(3) SOUND TEST

In the TEST mode menu, selecting SOUND TEST allows the screen (on which the monitor is tested sound) to be displayed. Make sure that all speakers are outputting correctly.

ADJUSTMENT OF SOUND VOLUME



Use dial adjustment volume on Main PCB to adjusting the volume of game.

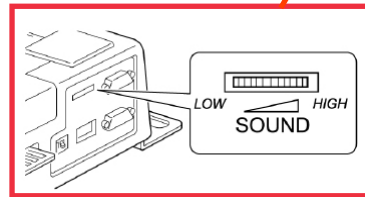
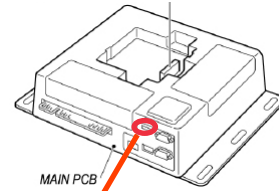

(4) I/O TEST AND GUN ADJUST

In the TEST mode menu, selecting I/O TEST allows the screen (on which the monitor is tested controller sight adjustment and input device) to be displayed. Prior to letting customers use the game, you must play a game and make sure that everything is operating correctly. Refer to 9-3-4 "I/O TEST AND GUN ADJUST" about controller sight adjustment details. Press each switch to check that each is working. If the display next to the input device changes to be "ON", switches and connections are working correctly.



7 PRECAUTIONS WHEN MOVING THE MACHINE

WARNING

- When moving the machine, be sure to pull out the plug from the power supply. Moving the machine with the plug still inserted can cause the power cord to be damaged, resulting in a fire and/or electric shock.
- When moving the machine on the floor, retract the adjusters, and ensure that the casters make contact with the floor. Pay careful attention so that the casters do not run over power cords and earth wires. Damaging the power cords can cause an electric shock and/or short circuit.
- When moving the cabinet, do not push it from the side. Push it from the back.
Pushing the cabinet from the side can have the cabinet fall down, causing personal injury, etc. In case the floor has slanted surfaces or step-like differences, be sure to move the machine by 2 or more persons.
- When detached always keep the cabinet on a level surface and make sure it does not start to lean to the left or right whilst working on it.

CAUTION

Do not push on any parts made of glass or plastic, as these parts may break and result in bodily injury.



IMPORTANT

When moving the cabinet do not hold or push the onitor panel. This could deform their shape or cause damage to them.

Pushing the cabinet from the side may make it fall over. Always push it from the back.

8 GAME DESCRIPTION

The following explanations apply to the product when functioning properly. If the product operates differently from the following contents, a fault may have occurred. Immediately look into and eliminate the cause of the fault to ensure proper operation.

Demo movies and game rankings are displayed on a monitor during power distribution.

Audio may also be played from speakers on the video cabinet and gun controller.

It is possible to select whether sound is output or not during Advertise mode through System menu.

8.1 GAME OUTLINE

Shoot clay throwing from a catapult.

1. Play back sound “PULL” before shooting out clay and clay is shot out in 2 seconds.



2. Shoot clay with a controller. 1st shot is shot out with pulling a trigger. When 1st shot doesn't hit, it is possible to shoot 2nd shot or next by pumping.



3. Select “Normal” (No shot limited) or “Expert” (Only 2 shots).



8.2 GAME MODE

Play each maximum 3 kinds of shooting.

1. SPORTING CLAYS

SPORTING CLAYS is to shoot clay like animal's movement. 5 shot stations in 1 stage and clay moves differently in each station.



2. SKEET SHOOTING

SKEET SHOOTING is to shoot clay throwing from left high house and right low house. 8 shoot stations in 1 stage.



3. TRAP SHOOTING

TRAP SHOOTING is to shoot clay shooting out randomly from trap house. 5 shoot station in 1 stage.



8.3 BONUS SHOOT

BONUS SHOOT is playable after 1 stage finished. 4 games (mentioned as below) are selected randomly. Limited time is 45 seconds.

1. BARREL SHOOTING

Aim correctly and shoot at the center of a rolling barrel.

Barrels are 20.

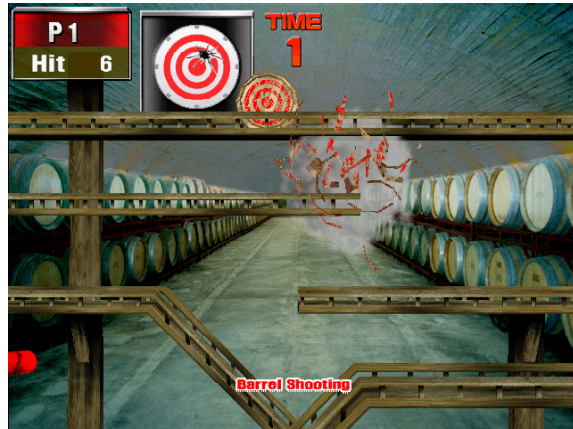

2. TARGET SHOOTING

Shoot quickly appearing aims. Aims are maximum 48.



3. TRICK SHOOTING

Shoot flying clay of various shots without mistakes. Clays are 30.



4. NIGHT SHOOTING

Shoot quickly and correctly lightning and flying clay without mistakes. Clays are 40.



8.4 NUMBER OF PLAYERS

1 to 6 persons are playable this game. Use left controller in a cabinet. Use only left controller in 3 to 6 players when "Alternative Play".



"Alternative Play" and "Head to Head Play" is selectable when 2 players. Use left controller in "Alternative Play". Use left controller in 1st player and right controller in 2nd player in "Head to Head Play".



1st player shoots red clay and 2nd player shoots blue clay. If a player shoots other player's clay, score is other player's. Targets are separated by red and blue in Bonus Shoot.

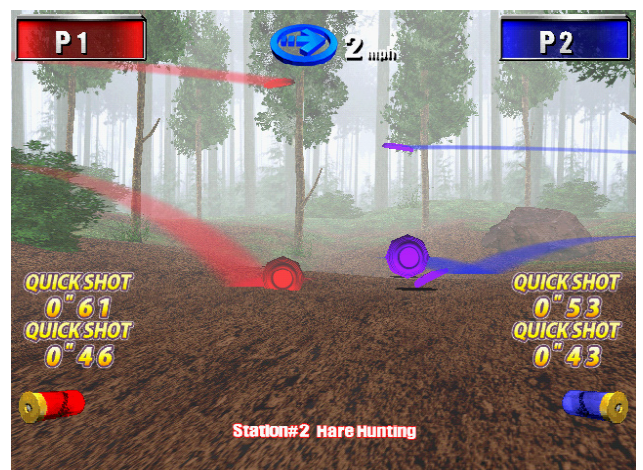

8.5 GAME FLOW

ADVERTISE



PLAY MODE SELECT



SELECT NUMBER OF PLAYERS



SELECT HEAD TO HEAD PLAY (ONLY 2 PLAYERS)



GAME MODE SELECT



SELECT ROUTE



SELECT SHOTGUN TYPE

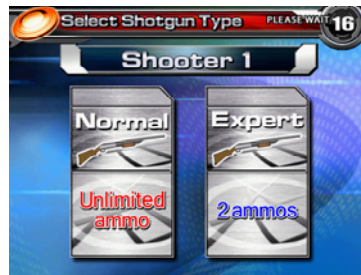

STAGE INTRODUCTION



TUTORIAL

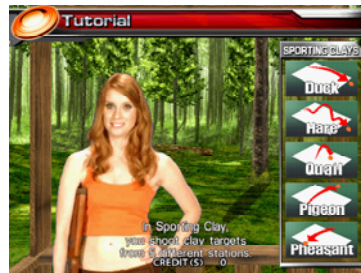

GAME PLAY (STATION 1)



NAME ENTRY

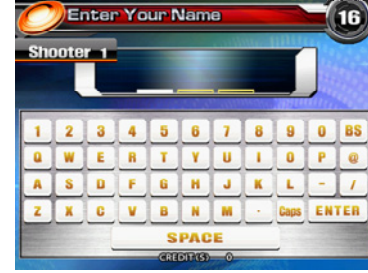

GAME PLAY (STATION 2 AND NEXT)



BONUS SHOOT



STAGE RESULTS



FINAL RESULTS (ON 3 STAGES) / GAME OVER



9 SYSTEM MENU

Perform periodic tests and data checks using the TEST/SERVICE button inside the coin door. Follow the instructions in this chapter to conduct checks when the game machine is first installed, when money is being collected, or when the game machine does not operate properly.

Shown below are the tests and screens to be used for different problems.

EXPLANATION OF SYSTEM MENU

ITEMS	DESCRIPTION	
INSTALLATION OF MACHINE	<ol style="list-style-type: none"> 1. Check to ensure each is the standard setting at shipment. 2. Check each Input equipment in the INPUT TEST mode. 3. Check each Output equipment in the OUTPUT TEST mode. 	
PERIODIC SERVICING	<p>Periodically perform the following:</p> <ol style="list-style-type: none"> 1. Ascertain each setting. 2. To test each Input equipment in the INPUT TEST mode. 3. To test each Output equipment in the OUTPUT TEST mode. 	
CONTROL SYSTEM	<ol style="list-style-type: none"> 1. To check each Input equipment in the INPUT TEST mode. 2. Adjust or replace each Input equipment 3. Check the mechanical functions 	
MONITOR	In the Monitor Adjustment mode, check to see if Monitor (Projector) adjustments are appropriate.	
DATA CHECK	Check such data as game play time and histogram to adjust the difficulty level, etc.	

9-1 SWITCH UNIT AND COIN METER

WARNING

Never touch places other than those specified. Touching places not specified can cause electric shock and short circuit accidents.

CAUTION

Be careful that a finger or hand does not get caught when opening/closing the coin chute door.

IMPORTANT

- When you enter the Test Mode, fractional coin and bonus adder data is erased.
- Adjust the sound to the optimum volume, taking into consideration the environmental requirements of the installation location.

SWITCH UNIT

Open the coin door, and the switch unit will appear. (Location of switch unit is different place depend of you cabinet)
The functioning of each SW is as follows:

TEST Button (TEST):

Enter in SYSTEM menu. It is used as a cursor move button in System menu.

SERVICE Button (SERVICE):

Insert a credit for service without turning up a coin meter. It is used as Select Button in System menu.

COIN METER

Open the Coin Door by using the key to have the Coin Counter appear. (Location of Coin meter unit is different place depend of you cabinet)

9-2 SYSTEM MENU

IMPORTANT

- When changing the game configuration, changes will not take effect until the Game Test Mode properly after configuration changes. Be sure to exit the Game Test Mode properly after configuration changes.
- Do not configure the game in ways not described in this text. It is possible that the game will not function properly.

Press the TEST Button to display the following SYSTEM TEST MENU after powering on the unit.



Use the TEST Button to move the cursor and the SERVICE Button to select. It is impossible to select gray items (COIN SETTINGS and NETWORK SETTINGS).

After test or setting are complete, move the cursor to EXIT and press Service Button to return Game Advertisement screen.

9-3 TEST MODE

9-3-1 TEST MODE MENU

Select GAME TEST MODE in System Menu screen to display Game Test Menu.



- 1) Press the TEST Button to move the cursor.
- 2) Move the cursor to the desired test item, and press the Service Button to return each test screen.
- 3) Move the cursor to EXIT after test is complete and press the TEST Button to return to System Menu.

9-3-2 COLOR TEST

Select COLOR TEST to display monitor color test.



Press the Service Button to return the TEST MODE menu after test is complete.

9-3-3 CROSS HATCH

Select CROSS HATCH to display monitor display size test.

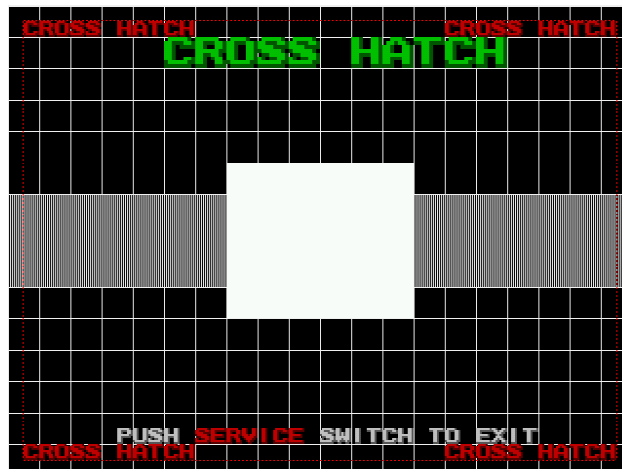

Press the Service Button to return the TEST MODE menu after test is complete.

STOP IMPORTANT

Content set in GUN ADJUST is recorded when selecting EXIT. Setting contents are invalid when power is off before EXIT.

9-3-4 I/O TEST AND GUN ADJUST (GUN TYPE => "NORMAL" in GAME SETTINGS)

For gun calibration, go to "TEST MENU" and select "I/O TEST". Screen shows calibration.



- 1) Pull a trigger to shoot the center of X mark by using 1st player and 2nd player controllers.
- 2) Press the Service Button to display Gun Test.



- 3) Pull both triggers to shoot a screen and a screen shows X mark. Shoot anywhere to test gun calibration. Test whether sound from a controller or not when shooting a screen.
- 4) Enter each switch, both Start Buttons and a pump and then a screen shows "ON" or "OFF" for each of them when activated.
- 5) Press the Service Button to return the TEST MODE menu after test is complete.

(GUN TYPE => "INFRARED" in GAME SETTINGS)

For gun calibration, go to "TEST MENU" and select "I/O TEST". Screen shows calibration.



- 1) Pull triggers of 1Player and 2 Player and shoot to X mark in upper left screen.
- 2) Pull triggers of 1Player and 2 Player and shoot to X mark in lower right screen.
- 3) Pull triggers of 1Player and 2 Player and shoot to X mark in center screen.
- 4) Press the Service Button to display gun test screen.



- 5) Pull both triggers to shoot a screen and a screen shows X mark. Shoot anywhere to test gun calibration. Test whether sound from a controller or not when shooting a screen.
- 6) Enter each switch, both Start Buttons and a pump and then screen shows "ON" or "OFF" for each of them when activated.
- 7) Press the Service Button to return TEST MODE menu after test is complete.

9-3-5 SOUND TEST

Select SOUND TEST to display stereo sound test screen, when setting “STEREO” in “AUDIO MODE” of SYSTEM SETTINGS.



- 1) Select “RIGHT” to output sound from right speaker.
- 2) Select “LEFT” to output sound from left speaker.
- 3) Select “CENTER” to output sound from both left & right speakers.
- 4) Select “STOP” to stop sound.
- 5) Select “EXIT” to go back to TEST MODE screen after test is complete.

Select SOUND TEST to display the monaural sound test screen, when setting “MONO” in AUDIO MODE of SYSTEM SETTINGS.

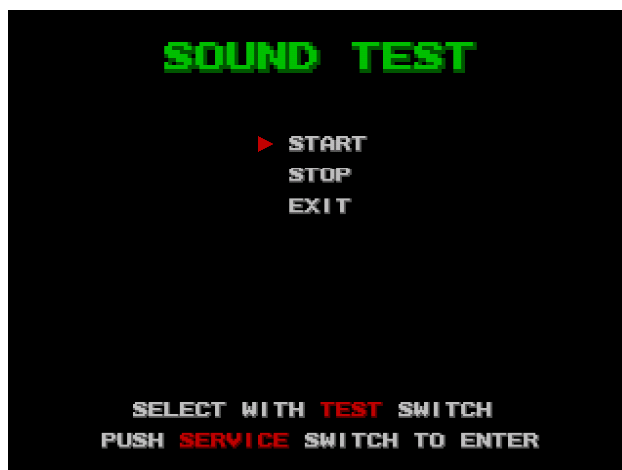

- 1) Select “START” to output sound.
- 2) Select “STOP” to stop sound.
- 3) Select “EXIT” to return to TEST MODE screen after test is complete,.

9-3-6 MEMORY TEST

Select MEMORY TEST to display Main PCB RAM test.



- 1) Press the TEST Button to start to R/W RAM test. This test can't be canceled until it is finished.
- 2) Press the Service Button to return the TEST MODE menu screen after test is complete.

9-4 CONFIGURATION



Content set in CONFIGURATION is recorded when selecting "SAVE&EXIT". Setting contents are invalid when power is off before "SAVE&EXIT".

9-4-1 CONFIGURATION

Select CONFIGURATION from the SYSTEM menu and CONFIGURATION menu screen is displayed.

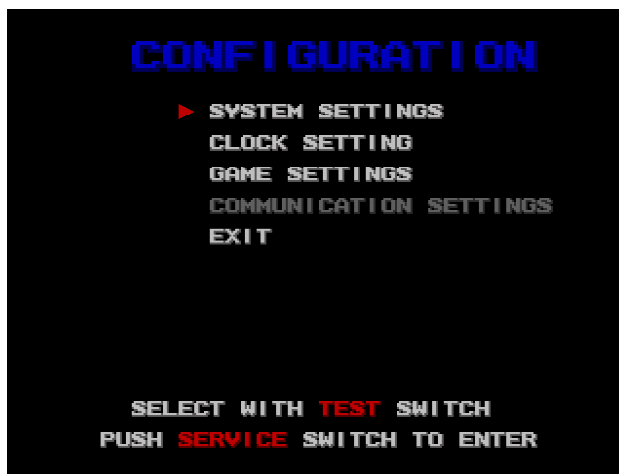

- 1) Press the TEST Button to move the cursor.
- 2) Move the cursor to the desired test item, and press the Service Button to move to each setting screen. Contents of "COMMUNICATION" are unavailable when game has no COMMUNICSTION feature.
- 3) Move the cursor to EXIT and press the TEST Button to return to the System Menu screen after setting is complete.

9-4-2 SYSTEM SETTINGS

Select SYSTEM SETTINGS to display the basic setting screen.

Use the Test Button to move the cursor to setting items and the Service Button to change setting value.

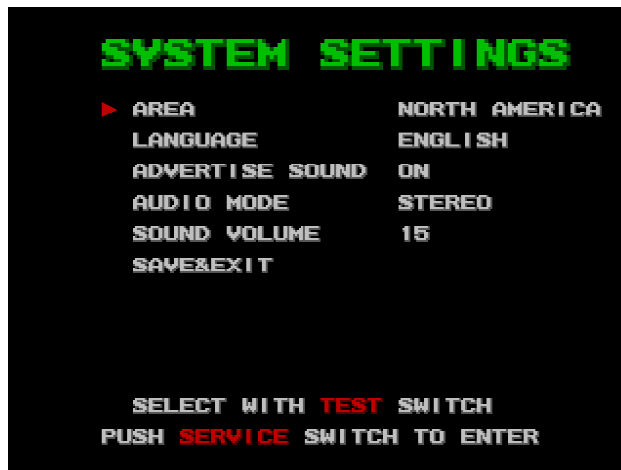

AREA: Set the operation area; NORTH AMERICA or EUROPE

LANGUAGE: ENGLISH

ADVERTISE SOUND: Set sound in Advertisement; “ON” or “OFF”

AUDIO MODE: Set sound output; “STEREO” or “MONO”

SOUND VOLUME: Set sound volume.; from 0 to 15

Move the cursor to “SAVE&EXIT” after setting change is complete. Press the Service Button to return to the SYSTEM menu after setting is saved.

9-4-3 CLOCK SETTINGS

Select CLOCK SETTINGS to display setting date and hour of Main PCB screen.
Use the TEST Button to move the cursor and the SERVICE Button to change the set value.



YEAR:	Set a year ; from 2002 to 2038.
MONTH:	Set a month; from 1 to 12.
DAY:	Set a day; from 1 to 31.
HOUR:	Set time; from 0 to 23.
MINUTE:	Set minutes; from 0 to 59.

Move the cursor to “SAVE&EXIT” after setting change is complete. Press SERVICE Button to return to SYSTEM menu after setting is saved.

9-4-4 GAME SETTINGS

Select GAME SETTINGS to display game setting screen.

Use the TEST Button to move the cursor and the SERVICE Button to change the set value.



- CONQUEST MODE: Set CONQUEST MODE ; “ON” or “OFF”
- USER CALIBRATION: Set player’s controller sight adjustment ; “ON” or “OFF”
- CLAY SHOOTING GIRL: Set to display girl’s movie; “ON” or “OFF”
- SCREEN ASPECT RATIO: Set screen rates ; “NORMAL”(4:3) or “WIDE”(16:9)
- DIFFICULTY LEVEL: Game levels are 5 by changing clay size and speed ;
VERY EASY->EASY->NORMAL->HARD->VERY HARD
- GUN TYPE: Set a kind of controllers ; “NORMAL” or “INFRARED”

STOP IMPORTANT

A controller doesn’t operate properly without restart when setting of GUN TYPE changes. The screen displays to restart message when setting are changed.

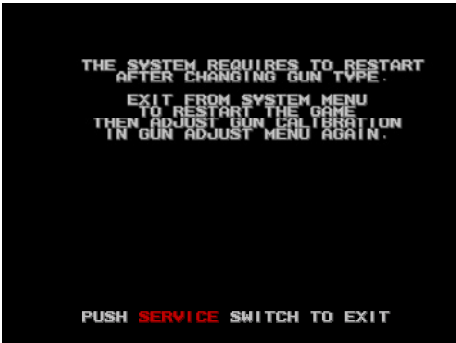

- GUN SOUND: Set to output sound of gun controller ; “ON” or “OFF”
- CREDIT SETTINGS: Set play fee. Refer to 9-4-5.

Move the cursor to “SAVE&EXIT” after setting change is complete. Press the SERVICE Button to return to SYSTEM menu after setting is saved.

9-4-5 CREDIT SETTINGS

Select CREDIT SETTINGS to display play fee setting screen. Use the TEST Button to move the cursor to the set item and the Service Button to change the set value.



GAME MODE:	Set GAME MODE ; “NORMAL” or “FREE PLAY”
NORMAL PLAY:	Set normal play fee; from 1to 16
CONTINUE PLAY:	Set continue play fee; from 1to 16 It is impossible to set larger than NORMAL PLAY value.
CONQUEST PLAY:	Set CONQUEST PLAY fee ; from 1 to 16 It is impossible to set smaller than NORMAL PLAY value.
CURRENCY TYPE:	Set currency ; DOLLAR or CREDIT

Move the cursor to “SAVE&EXIT” after setting change is complete. Press the Service Button to return to the SYSTEM menu after setting is saved.

9-5 BOOKKEEPING

9-5-1 BOOKKEEPING

Select BOOKKEEPING to display contents of operation status. Data is saved in SRAM of Main PCB. Use the Test Button to move the cursor to check items and Service Button to display.

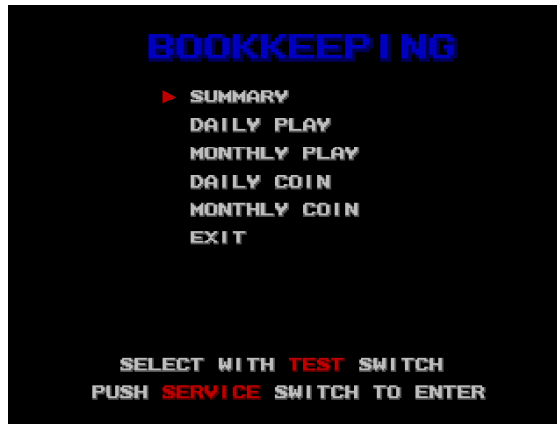

Move the cursor to “EXIT” after checking operation status and press Service Button to return to System menu.

9-5-2 SUMMARY

Select SUMMARY to display data summary.

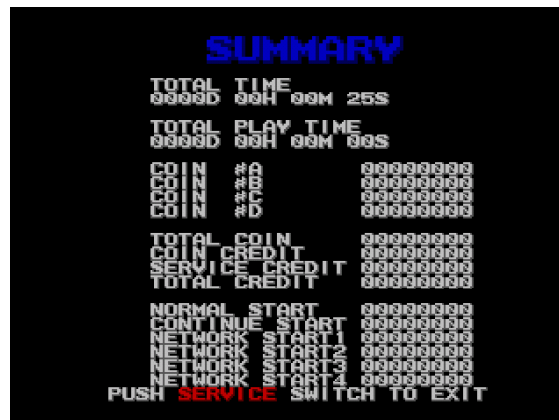

TOTAL TIME:	The time when game is powered on.
TOTAL PLAY TIME:	Total play time
COIN #A:	Coin numbers in Coin Chute 1
COIN #B:	Coin numbers in Coin Chute 2
COIN #C:	Coin numbers in Coin Chute 3
COIN #D:	Coin numbers in Coin Chute 4
TOTAL COIN:	Total Coin numbers from Coin chute 1 to 4
COIN CREDIT:	Credit numbers by coin inserting.
SERVICE CREDIT:	Credit numbers by Service Button
TOTAL CREDIT:	Total credit numbers
NORMAL START:	Usual game play numbers
CONTINUE START:	Play numbers by continue
NETWORK START1:	This is not used in this game.
NETWORK START2:	This is not used in this game.
NETWORK START3:	This is not used in this game.
NETWORK START4:	This is not used in this game.

Press Service Button to return to BOOKKEEPING menu screen after checking data.

9-5-3 DAILY PLAY

Select DAILY PLAY to display daily play checking screen. Daily play number, continue number, average play time display.

DAILY PLAY DATA1

DATE	PLAY	CONT	AVE PLAY TIME
10/11/08 MON	0	0	0h 0m 0s

PUSH **SERVICE** SWITCH TO EXIT

After checking, press Service Button to display next page. Return to BOOKKEEPING menu when last page displayed.

9-5-4 MONTHLY PLAY

Select MONTHLY PLAY to display monthly play checking screen. Monthly play number; continue number and average play time display.

MONTHLY PLAY DATA1

DATE	PLAY	CONT	AVE PLAY TIME
Nov . 08	0	0	0h 0m 0s
TOTAL	0	0	0h 0m 0s

PUSH **SERVICE** SWITCH TO EXIT

After checking, press the Service Button to display next page. Return to BOOKKEEPING menu screen when last page displayed.

9-5-5 DAILY COIN DATA

Select DAILY COIN DATA to display daily coin insert checking screen. Daily coin insert number of coin chute 1 to 4 and credit number by Service Button display.



After checking, press the Service Button to display next page. Return to BOOKKEEPING menu screen when last page displayed.

9-5-6 MONTHLY COIN DATA

Select MONTHLY COIN DATA to display monthly coin insert checking screen. Monthly coin insert number of coin chute 1 to 4 and credit number by Service Button display.

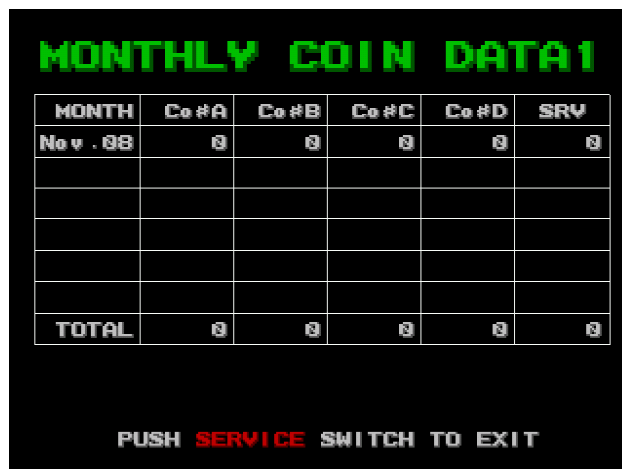

After checking, press Service Button to display next page. Return to BOOKKEEPING menu when last page displayed.

9-6 BACKUP CLEAR

9-6-1 BACKUP CLEAR

Select BACKUP CLEAR to display the following screen. Use the Test Button to move the cursor to clear items and Service Button to decide.

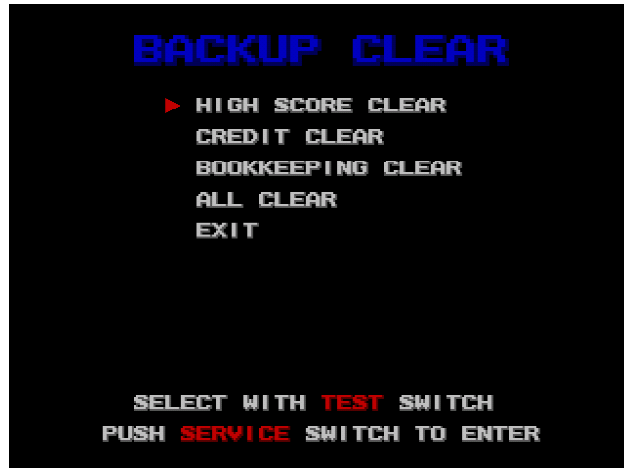

After data is clear, move the cursor to “EXIT” and press Service Button to return System menu.

9-6-2 HIGH SCORE CLEAR

Select HIGH SCORE CLEAR to display the following screen. Use the Test Button to move the cursor “YES” (Enter) or “NO” (Cancel) and Service Button to decide and return to BACKUP CLEAR menu.

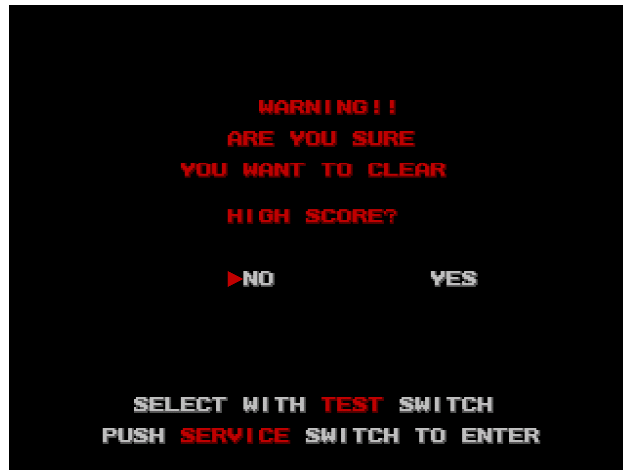

9-6-3 CREDIT CLEAR

Select CREDIT CLEAR to display the following screen. Use the Test Button to move the cursor “YES” (Enter) or “NO” (Cancel) and Service Button to decide and return to BACKUP CLEAR menu.

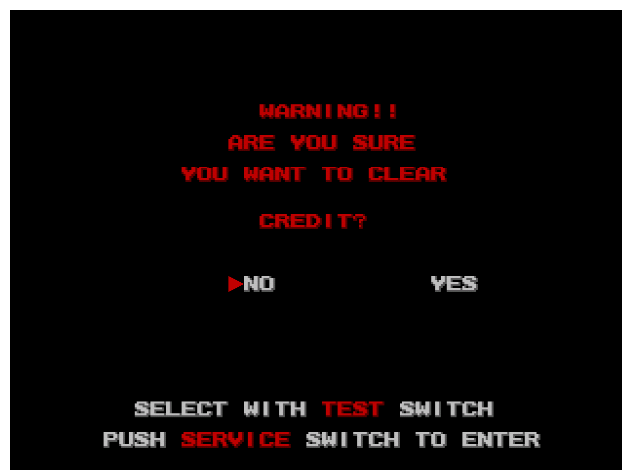

9-6-4 BOOKKEEPING CLEAR

Select BOOKKEEPING CLEAR to display the following screen. Use Test Button to move the cursor “YES” (Enter) or “NO” (Cancel) and Service Button to decide and return to BACKUP CLEAR menu.

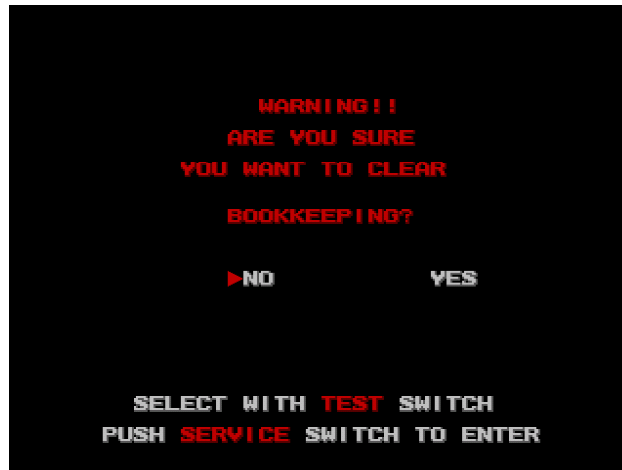

9-6-5 ALL CLEAR

Select ALL CLEAR to display the following screen. Use the Test Button to “YES” (Enter) or “No” (Cancel) and the Service Button to decide and return to BACKUP CLEAR menu.

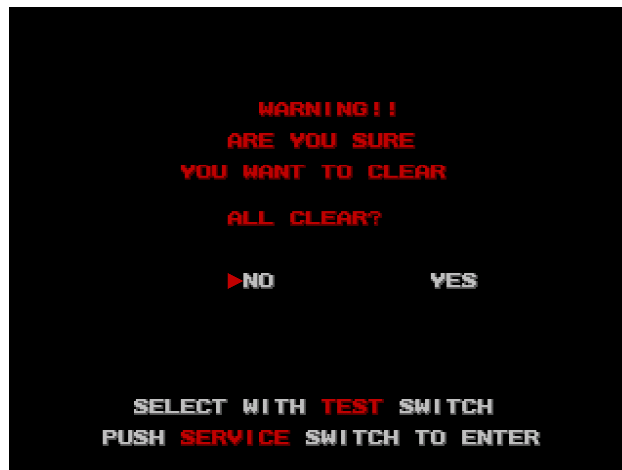

10 PERIODIC INSPECTION

The items listed below require periodic check and maintenance to retain the performance of this machine and to ensure safe business operation.

When handling the controller, the player will be in direct contact with it. In order to always allow the player to enjoy the game, be sure to clean it regularly. Also, it is advisable to provide wet tissue, etc. available for player use.

⚠ WARNING

- **Once a year, check to see if power cords are damaged, the plug is securely inserted, dust is accumulated between the socket outlet and the power plug, etc. Using the product with accumulated dust in the interior may cause fire or electric shock.**
- **Never use a water jet, etc. to clean the inside and outside of the cabinet. If wetness occurs for any reason, do not use the product until it has completely dried.**
- **Once a year, request the office shown on this manual or the dealer from whom the product was originally purchased to perform the internal cleaning. Using the product with accumulated dust in the interior may cause fire or other accidents. Note that you are liable for the cost of cleaning the interior parts.**
- **There is the danger of accidents involving electrical shorts circuits or fire caused by factors such as the deterioration of insulation in electrical and electronic equipment over time. Check that there are no abnormalities such as odors from burning.**

Cleaning the Cabinet Surfaces

When the cabinet surfaces are badly soiled, remove stains with a soft cloth dipped in water or diluted (with water) chemical detergent and squeezed dry. To avoid damaging surface finish, do not use such solvents as thinner, benzene, etc. other than ethyl alcohol, or abrasives, bleaching agent and chemical dustcloth.

Some general-purpose household, kitchen and furniture cleaning products may contain strong solvents that degrade plastic components, coatings, and print. Before using any cleaning product, read the product's cautionary notes carefully and test the product first on a small area that is not highly visible.

11 TROUBLESHOOTING

11-1 TROUBLESHOOTING (WHEN NO ERROR MESSAGE IS SHOWN)

⚠ WARNING

- In order to prevent electric shock and short circuit, be sure to turn power off before performing work.
- Be careful so as not to damage wirings. Damaged wiring can cause electric shock or short circuit.
- After removing the cause of the functioning of the Circuit Protector, reinstate the Circuit Protector. Depending on the cause of the functioning, using the Circuit Protector as is without removing the cause can cause generation of heat and fire hazard.
- In the event that a problem cannot be resolved by employing the procedures listed in this Manual, be sure to request service from the office shown on this Manual or the dealer from whom the product was originally purchased. Attempts to employ procedures other than those specified in this Manual can cause electrical shock, shorting, or fire.
- In the event of a problem that is not described here, be sure to contact the office shown on this Manual or the dealer from whom the product was originally purchased. Careless attempts at repair can result in electrical shock, shorting, or fire.

PROBLEMS	CAUSE	COUNTERMEASURES
With Main SW ON, no activation.	Power is not supplied.	Securely insert the power plug into the plug socket.
	Power supply/voltage is not correct.	Make sure that power supply/voltage is correct.
	The circuit breaker on the power supply functioned due to momentary overcurrent.	After eliminating the cause of overload, have the circuit breaker restored.
The color on the monitor screen is incorrect.	Image adjustment is not appropriate.	Adjust appropriately
No sound is emitted.	Sound volume adjustment is not appropriate.	Adjust sound volume
	Board and Amplifier malfunctioning	Perform the sound test and confirm

11-2 ERROR CODE

This product displays the following messages when it detects an error.

ERROR 00
DISPLAY
CAUSE
ACTION

MAIN MEMORY ERROR
Abnormality of Memory RAM on ATOMISWAVE PCB.
Need exchange or repair of Main PCB.

ERROR 01
DISPLAY
CAUSE
ACTION

ROM CARTRIDGE INCLUDES FATAL ERROR
ROM cartridge is not correctly set or abnormality is found in ROM cartridge
Need exchange or repair ROM cartridge.

DISPLAY
CAUSE
COUNTERMEASURES

COIN ERROR
Coin is jammed or coin switch is abnormality.
Check coin mech, coin switch, and harnesses to coin switch.

12 GAME BOARD

⚠️WARNING

- In order to prevent electric shock and short circuit hazards, be sure to turn power off before performing work.
- Be careful not to damage the wires. Damaged wires may cause electric shock or short circuit or present a fire risk.
- When replacing or repairing the game board and then returning it to the cabinet, be sure to reconnect all the connectors correctly. Improper connection may cause electric shock, short circuit or fire.
- When connecting the connector, check the orientation carefully and connect securely. The connector must be connected in the proper direction. If it is connected in the wrong direction or indiscriminately at an incline so that a load is applied, the connector or its terminal pins could break, causing a short circuit or fire.
- No connectors other than those connected on the game board when first delivered can be used by this product. Do not connect any other wires to any of the unused connections. This may lead to the generation of heat, smoke or burn outs.

⚠️CAUTION

In this product, setting changes are made during the test mode. The game board need not be operated. Use the game board, etc. as is with the same setting made at the time of shipment so as not to cause electric shock and malfunctioning.

DIMENSIONS: 10.67" W x 9.04" D x 2.52" H
WEIGHT: 3 lbs

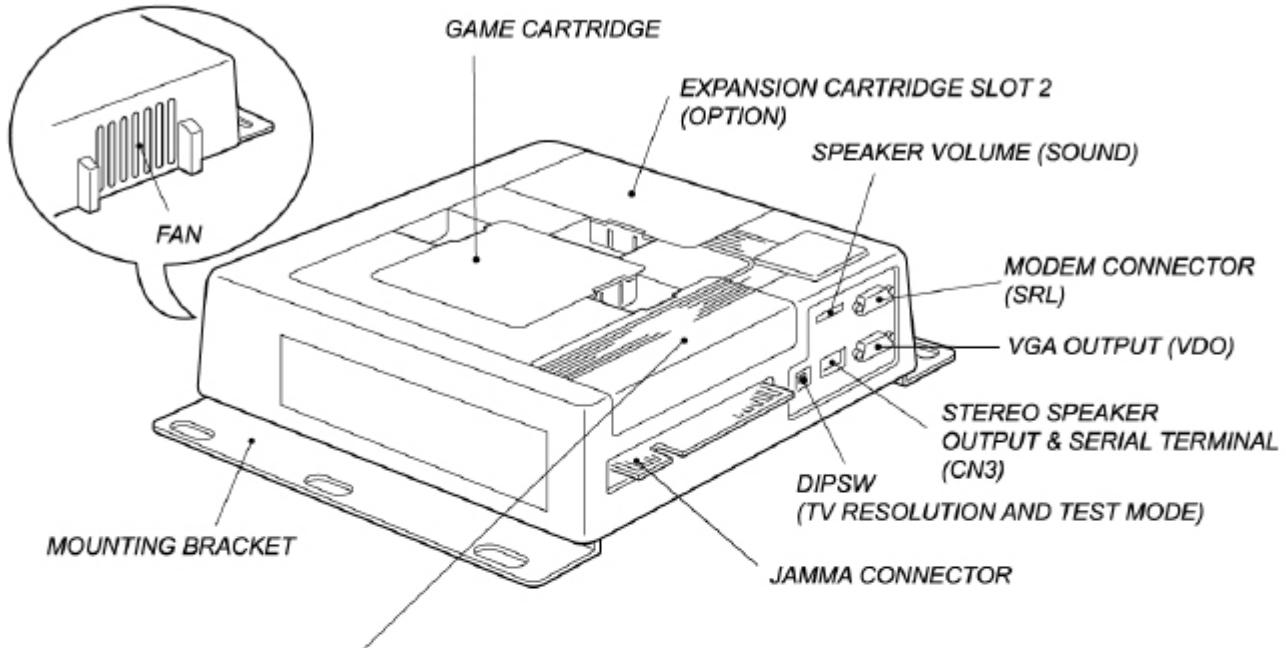

■ **EXPANSION CARTRIDGE SLOT 1
 (EX. I/O BOARD) CONNECTOR TABLE**

CN303: 8 PIN CONNECTOR

PIN#	FUNCTION
1	+5VDC
2	+5VDC
3	GND
4	GND
5	ANALOG 0
6	ANALOG 1
7	ANALOG 2
8	ANALOG 3

CN304: 12 PIN CONNECTOR

PIN#	FUNCTION
1	+5VDC
2	+5VDC
3	GND
4	GND
5	POUT 0
6	POUT 1
7	POUT 2
8	POUT 3
9	POUT 4
10	POUT 5
11	POUT 6
12	POUT 7

CN302: 28 PIN CONNECTOR

PIN#	FUNCTION	PIN#	FUNCTION
1	+5VDC	2	+5VDC
3	GND	4	GND
5	3P GUN	6	4P GUN
7	3PUP/PULX1	8	4PUP/PULX1
9	3PDO/PULX2	10	4PDO/PULX2
11	3PLE/PULY1	12	4PLE/PULY1
13	3PRI/PULY2	14	4PRI/PULY2
15	3P COIN	16	4P COIN
17	3P START	18	4P START
19	3PPU1/TRIG	20	4PPU1/TRIG
21	3P PUSH2	22	4P PUSH2
23	3P PUSH3	24	4P PUSH3
25	3P PUSH4	26	4P PUSH4
27	3P PUSH5	28	4P PUSH5

■ JAMMA CONNECTOR TABLE

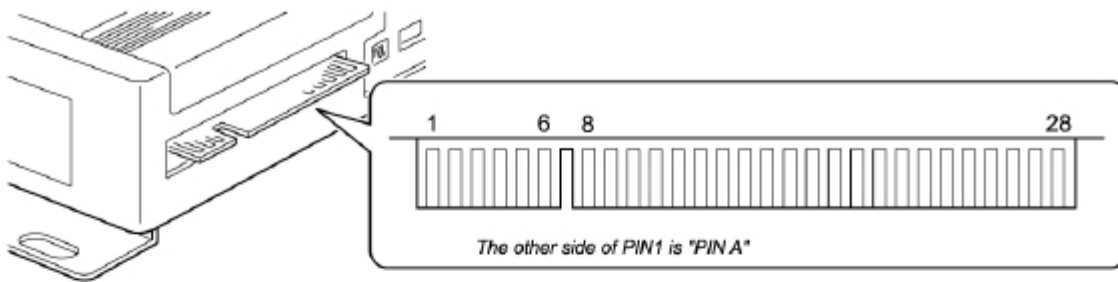

JAMMA EDGE CONNECTOR (56 PINS)

No.	FUNCTION	I/O	No.	FUNCTION	I/O
1	GND	-	A	GND	-
2	GND	-	B	GND	-
3	+5V	IN	C	+5V	IN
4	+5V	IN	D	+5V	IN
5	N.C.	-	E	N.C.	-
6	+12V	IN	F	+12V	IN
7	N.C.	-	H	N.C.	-
8	1P COIN COUNTER	OUT	J	2P COIN COUNTER	OUT
9	1P COIN LOCKOUT	OUT	K	2P COIN LOCKOUT	OUT
10	MONO SPEAKER (+)	OUT	L	MONO SPEAKER (-)	OUT
11	AUDIO OUT	OUT	M	AUDIO GND	-
12	VIDEO RED	OUT	N	VIDEO GREEN	OUT
13	VIDEO BLUE	OUT	P	VIDEO SYNC	OUT
14	VIDEO GND	-	R	SERVICE SW	IN
15	TEST SW	IN	S	TILT SW	IN
16	1P COIN	IN	T	2P COIN	IN
17	1P START	IN	U	2P START	IN
18	NOT USED	IN	V	NOT USED	IN
19	NOT USED	IN	W	NOT USED	IN
20	NOT USED	IN	X	NOT USED	IN
21	NOT USED	IN	Y	NOT USED	IN
22	1P PUMP	IN	Z	2P PUMP	IN
23	NOT USED	IN	a	NOT USED	IN
24	NOT USED	IN	b	NOT USED	IN
25	NOT USED	IN	c	NOT USED	IN
26	NOT USED	IN	d	NOT USED	IN
27	GND	-	e	GND	-
28	GND	-	f	GND	-

■ SPEAKER VOLUME (SOUND)

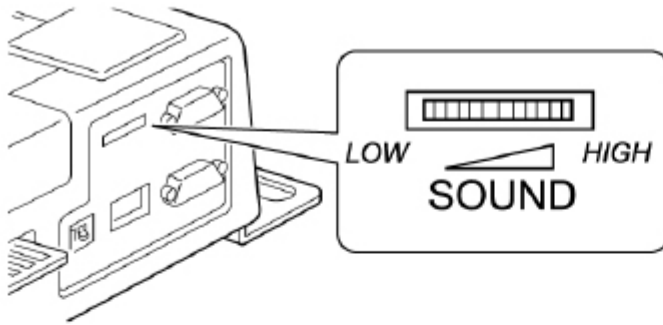

Use for adjusting game sound

■ MODEM CONNECTOR (SRL) >>> OPTION

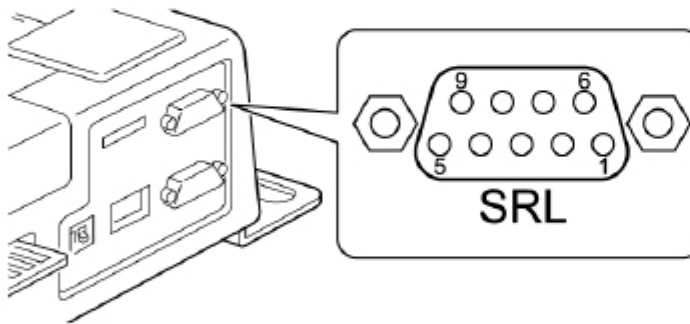

JST 9PIN SUB, CONNECTOR (MALE)

No.	FUNCTION	I/O
1	(N.C.)	-
2	RXD2	IN
3	TXD2	OUT
4	DTR	OUT
5	GND	-
6	(N.C.)	-
7	RTS	OUT
8	CTS	IN
9	(N.C.)	-

■ DIP SWITCH (2 POSITIONS)

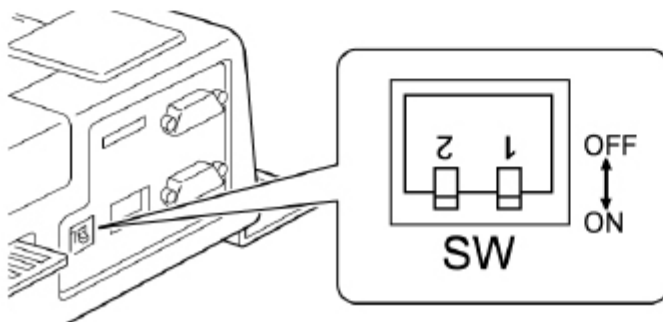

SW-1: Change Frequency of TV signal. Default is OFF = 15KHz*

*For Standard = Low resolution monitor

SW-2: Change ON position to go to SYSTEM MENU.

	ON	OFF
SW-1	31KHZ	15KHZ
SW-2	SYSTEM MENU MODE	GAME MODE

■ STEREO SPEAKER OUTPUT CONNECTOR (OPTION)

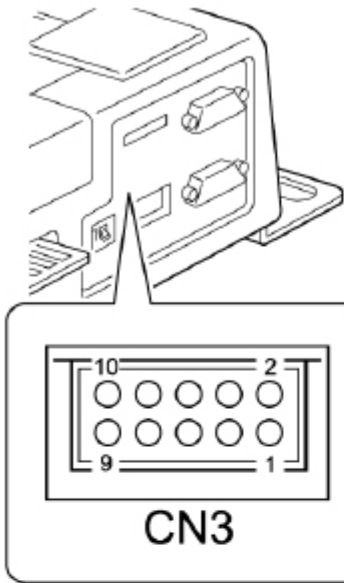

NOTE:
Can not use JAMMA speaker output & STEREO speaker output at same time.

STEREO SPEAKER OUTPUT & EXTENSION SERIAL CONNECTOR, PIN LAYOUT
(JST, 10 PIN PHD CONNECTOR)

No.	FUNCTION	I/O	No.	FUNCTION	I/O
1	STEREO SPEAKER L (+)	OUT	2	TXD	OUT
3	STEREO SPEAKER L (-)	OUT	4	RXD	IN
5	STEREO SPEAKER R (+)	OUT	6	GND	-
7	STEREO SPEAKER R (-)	OUT	8	+5V	OUT
9	N.C.	-	10	N.C.	-

■ VGA (31KHz) TV SIGNAL OUTPUT CONNECTOR (VDO) >>>OPTION

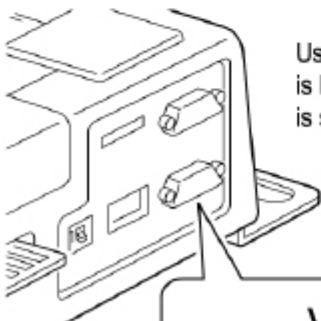

Use this connector when TV Monitor is High Resolution. Make sure DIPSW #1 is set to ON position.

VGA OUTPUT CONNECTOR, PIN LAYOUT
(JST, 15 PIN D-SUB CONNECTOR, 3 SEQUENCE, FEMALE)

No.	FUNCTION	I/O
1	R	OUT
2	G	OUT
3	B	OUT
4	N.C.	-
5	GND	-
6	R-GND	-
7	G-GND	-
8	B-GND	-
9	+5V	OUT
10	GND	-
11	N.C.	-
12	N.C.	-
13	COMP SYNC	OUT
14	N.C.	-
15	N.C.	-

■ GAME CARTRIDGE**HOW TO MOUNT GAME CARTRIDGE**

*Check position of connector for both game cartridge and slot in MAIN PCB.
Then insert Game Cartridge.
Make sure that Game Cartridge is locked by hooks.*

HOW TO REMOVE GAME CARTRIDGE

*Pinch both Hooks on game cartridge,
then pull game cartridge out.*

*When you exchange Game Cartridge to
another Game Cartridge, all backup data
(bookkeeping data) will be cleared. Then
all settings will go back to default settings.*

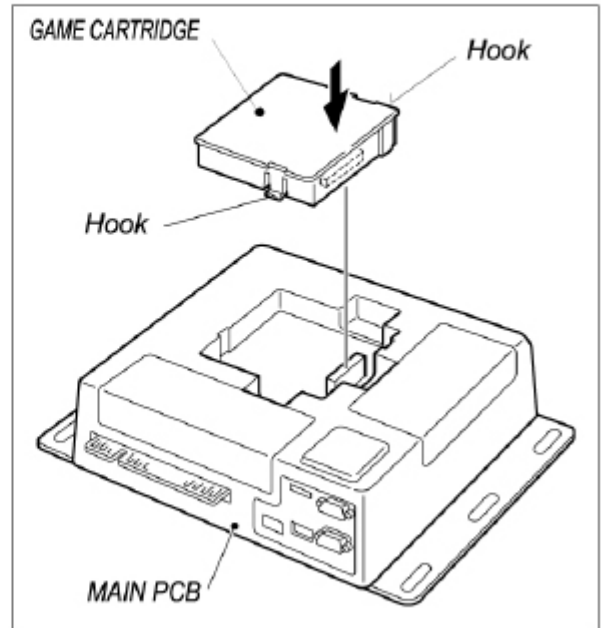

13 CABINET PARTS DESCRIPTION

INSIDE VIEW OF CONTROL PANEL & INSTRUCTION PANEL, AW25"UR

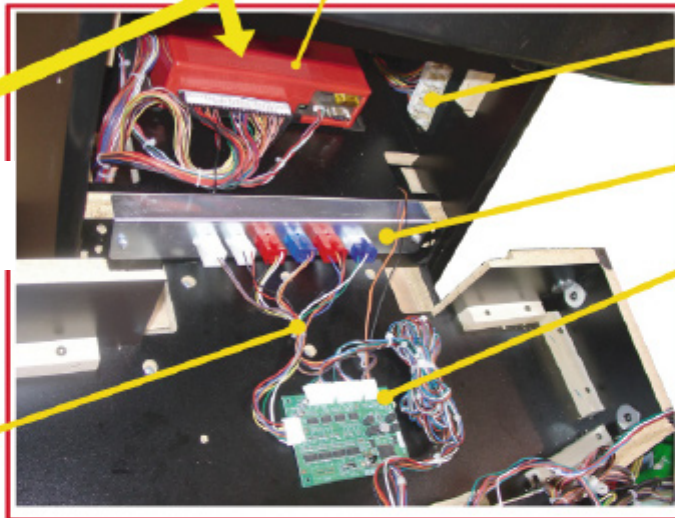
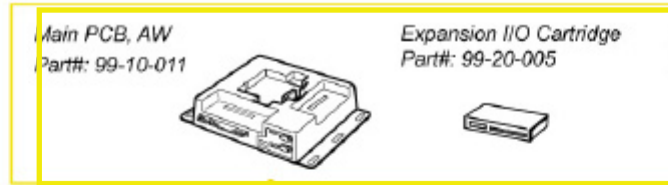

GAME CARTRIDGE
Clay Shooting
PART# 910-0752P

Remote Controller
for Monitor

Connector Bracket

SOUND BD GUN
Part#: 837-14593P

New Gun Sub Harness (DED)
Part#: 99-60-683

INSIDE VIEW OF COIN DOOR, AW25"UR & 29"UR

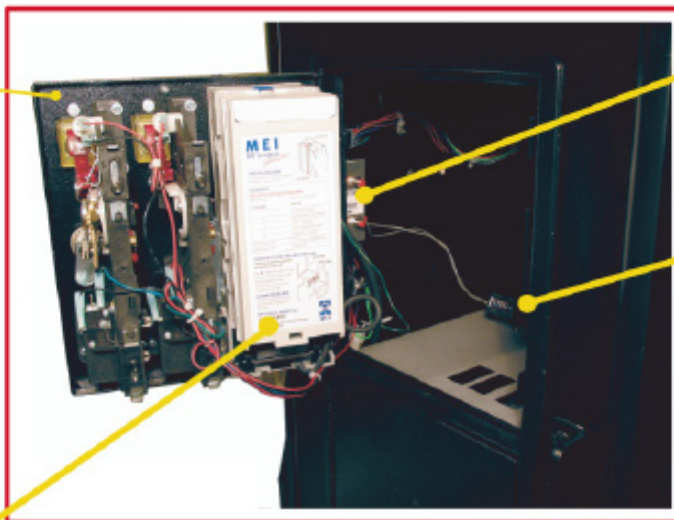

Coin Door Mid Width 40-3000
Part#: 99-70-103

Security Bar KIT, MID
(Option)
Part#: 99-70-278

Test & Service
Switch Bracket

Meter 12 Volt Coin Door
Part#: 99-70-184



Mars DBA
AE2451 (OPTION)

14 PARTS LIST, CONTROLLER

ASSEMBLE VIEW, 28" SHOTGUN WITH SPEAKER ASSY

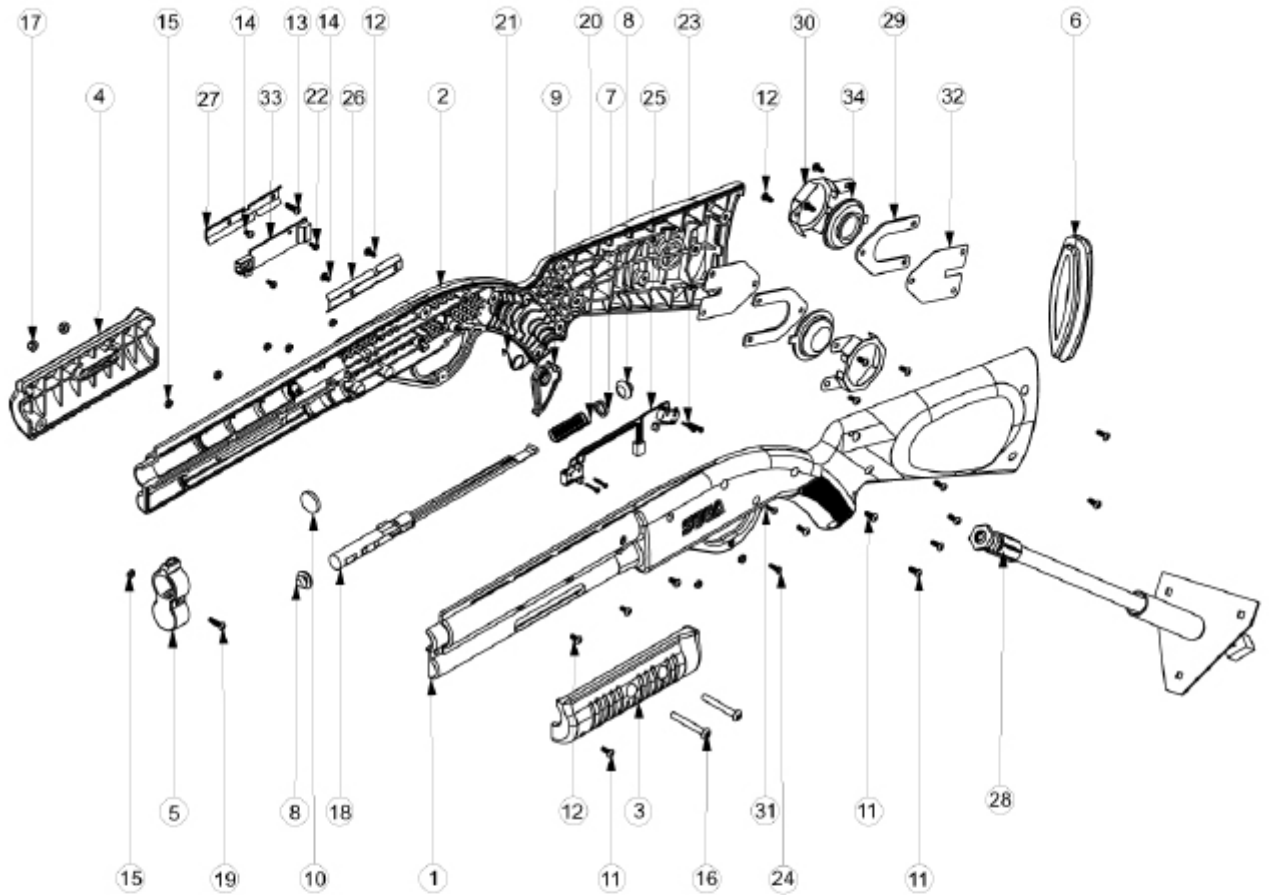

No.	Part number	Part name	QTY	No.	Part number	Part name	QTY
1	99-50-328	Housing L Half Shotgun w/Speaker	1	18	99-50-325	Activation Bar Shotgun	1
2	99-50-329	Housing R Half Shotgun w/Speaker	1	19		Screw 6-32 x 9/16 BH Torx	1
3	99-50-330	Pump L Half Shotgun w/Speaker	1	20	99-50-317	Spring Pump Camevil Shotgun	1
4	99-50-331	Pump R Half Shotgun w/Speaker	1	21	99-50-322	Torsion Spring Trigger Shotgun	1
5	99-50-332	Front Cap Shotgun w/Speaker	1	22		Screw, 4-40-x .25 PH.PN.HD	2
6	99-50-321	Rear Cap (Butt) 27" Shotgun	1	23		Screw, #2 x 1/2 Type B.PPH	4
7	99-50-327	Washer Plastic F/Pump Shotgun	1	24		Screw, #4 PH PN HD TP B .38 L.	1
8	99-50-326	Rubber Bumper Lavelle 16-86PB	2	25	99-50-323	Trigger & Pump Switch and Harness	1
9	99-50-318	Trigger for Shotgun/Rifle	1	26	99-50-333	Shield Plate L.H. Shotgun w/SPKR	1
10	99-50-314	Lens Glass for Shotgun	1	27	99-50-334	Shield Plate R.H. Shotgun w/SPKR	1
11		Screw 6-32 x 3/8 BHMS T-10 Torx	9	28	99-50-339	Hose & Harness Shotgun w/SPKR	1
12		Screw 6-32 x 5/16 BHMS T-10 Torx	10	29	99-50-337	SP Holder BKT Shotgun w/SPKR	2
13		Screw 6-32 x 1/2 BH Torx	1	30	99-50-336	SP Cover BKT Shotgun w/SPKR	2
14		Screw 6-32 x 7/32 BHMS T-Torx	2	31		Screw 4-40 x 3/8 BHMS T-10 Torx	1
15		Nut hex 6-32 .25A.F. Black Oxide	8	32	99-50-338	SP Base BKT Shotgun w/SPKR	2
16		SCR 10-32 x 1-1/2 BH Torx Black	2	33	837-14592	Sensor Board, 28"shotgun w/speaker	1
17		Nut Hex 10-32 Jam Nylock Zinc Plated	2	34	130-5262P	Speaker, 28"shotgun	2

15 WIRE COLOR CODE TABLE

WARNING

The DC power wire color for this product is different from previous SEGA titles. Working from the previous wire colors will create a high risk of fire.

The color codes for the wires used in the diagrams in the following chapter are as follows.

- A PINK
- B SKY BLUE
- C BROWN
- D PURPLE
- E LIGHT GREEN

Wires other than those of any of the above 5 single colors will be displayed by 2 alphanumeric characters.

- 1 RED
- 2 BLUE
- 3 YELLOW
- 4 GREEN
- 5 WHITE
- 7 ORANGE
- 8 BLACK
- 9 GRAY

If the right-hand side numeral of the code is 0, then the wire will be of a single color shown by the left-hand side numeral (see the above).

Note 1: If the right-hand side numeral is not 0, that particular wire has a spiral color code. The left-hand side character shows the base color and the right-hand side one, the spiral color.

<Example> 51..... WHITE/RED

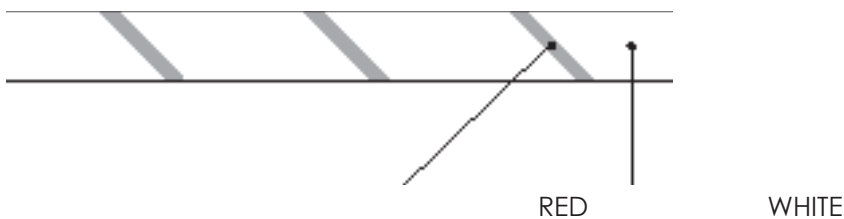

Note 2: The character following the wire color code indicates the size of the wire.

- U: AWG16
- K: AWG18
- L: AWG20
- None: AWG22

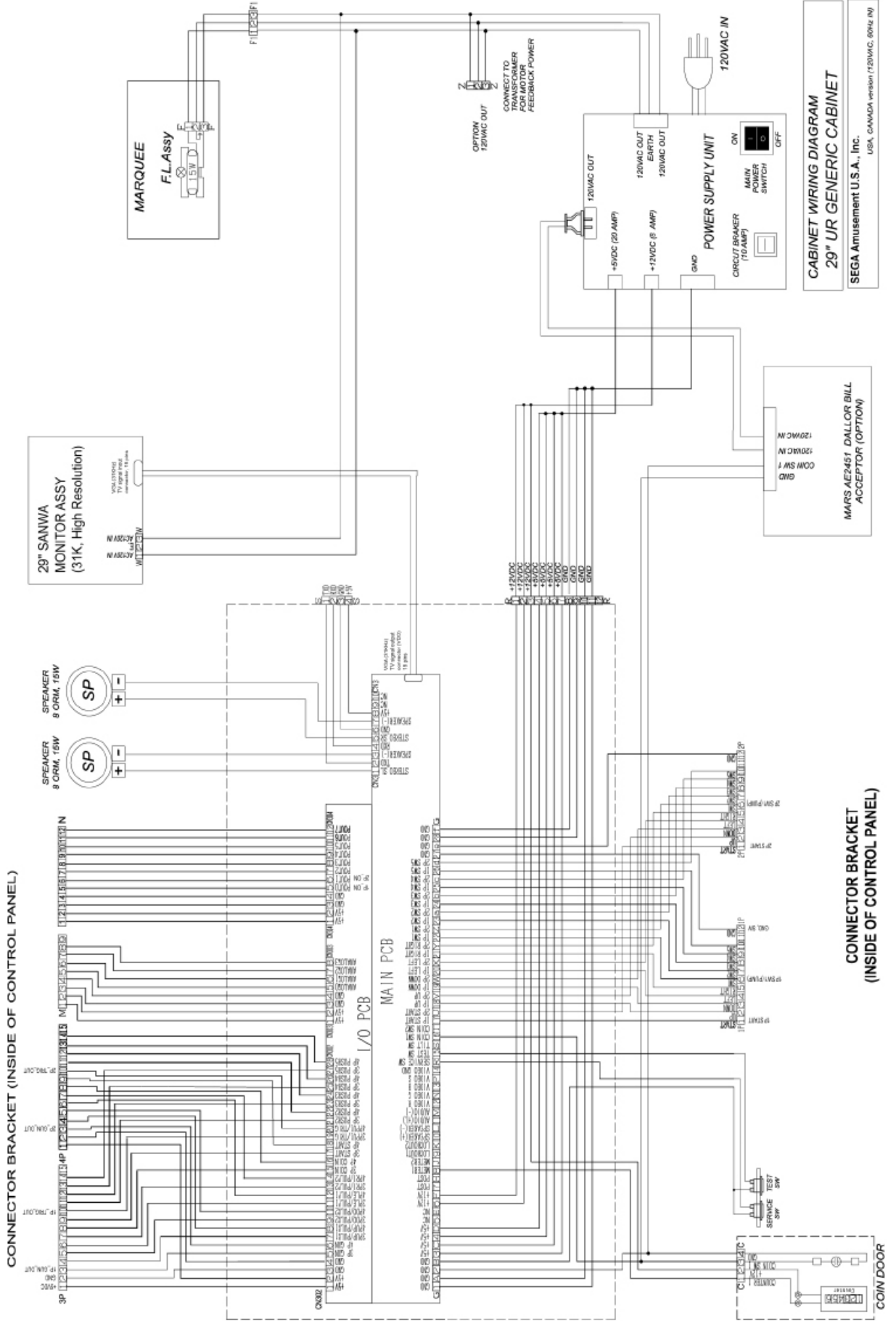

16 WIRING DIAGRAM

NEW GUN SUB HARNESS (DED)
Part#: 99-60-683

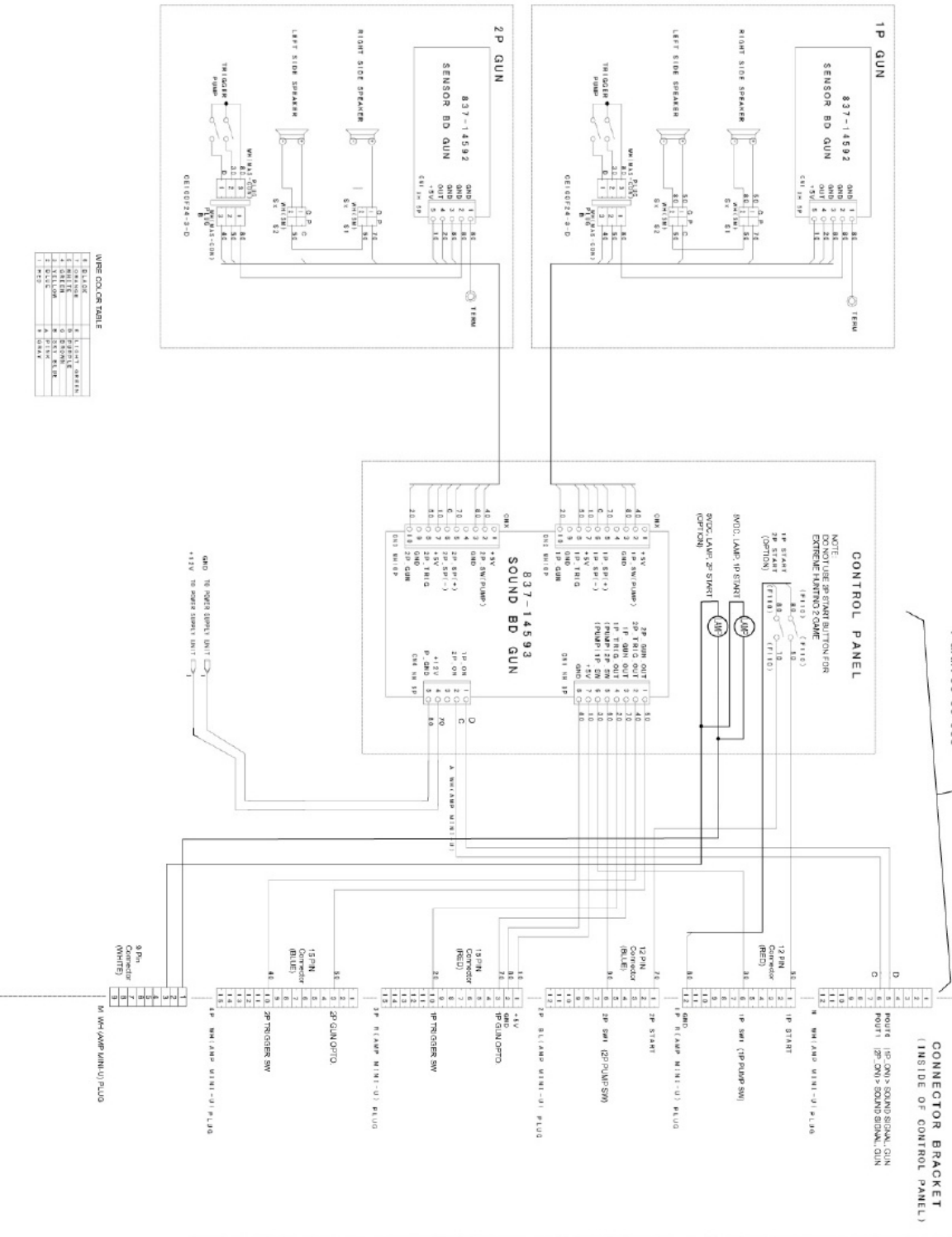

WIRE COLOR TABLE

1	BLACK	1	BLACK
2	RED	2	RED
3	GREEN	3	GREEN
4	YELLOW	4	YELLOW
5	BLUE	5	BLUE
6	WHITE	6	WHITE
7	BROWN	7	BROWN
8	PINK	8	PINK
9	GRAY	9	GRAY

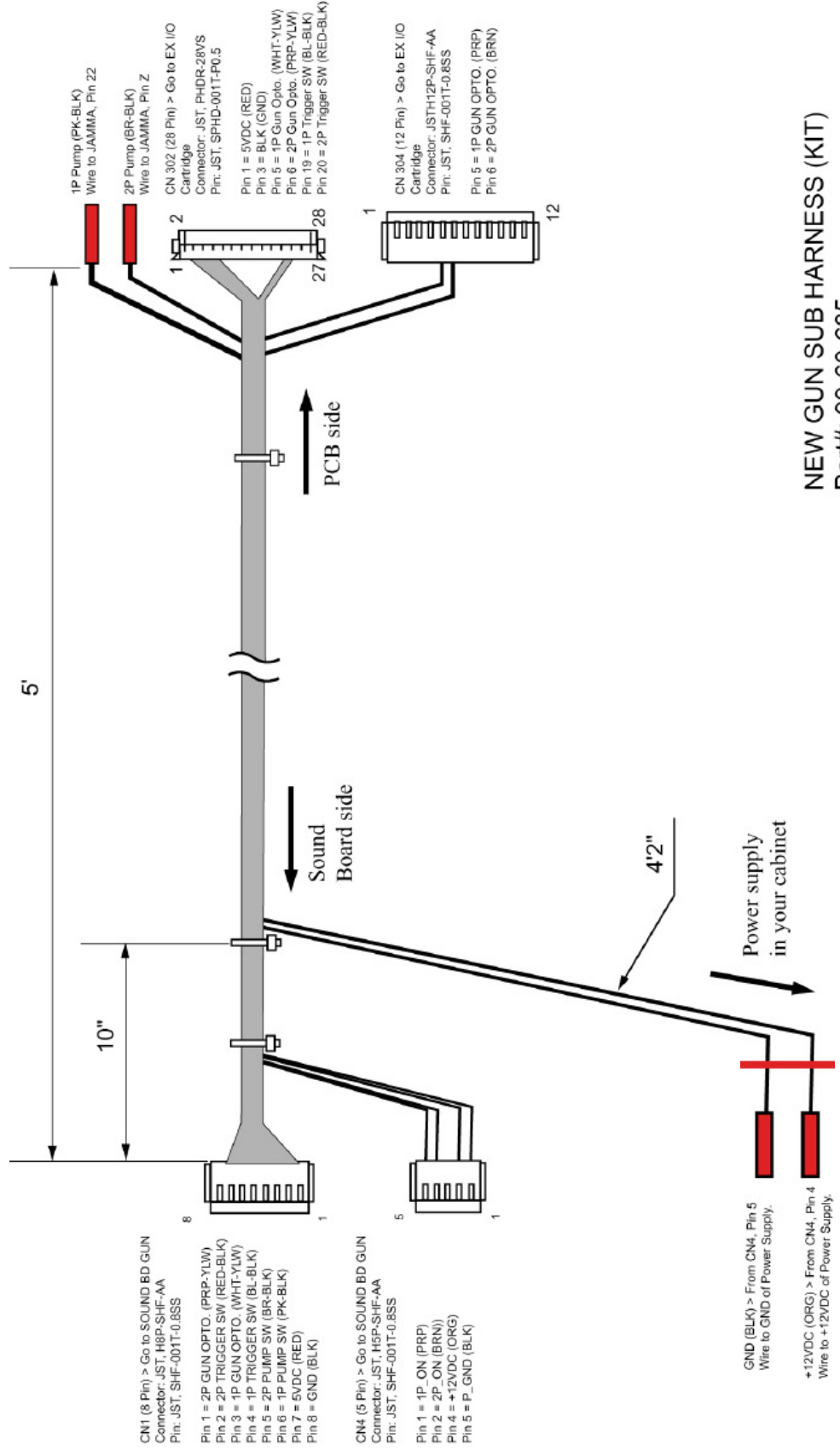

NEW GUN SUB HARNESS (KIT)
Part#: 99-60-685

17 LICENSE MARK

The Font to be used in the game.

The typefaces included herein are solely developed by DynaComware.

WARRANTIES

GAME WARRANTY POLICY

Your new SEGA PRODUCT is covered for a period of ninety (90) days from the date of the shipment. This certifies that all Printed Circuit boards, power supplies and monitors are to be free of defects in workmanship or materials under normal operating conditions.

This also certifies that all Interactive Control Assemblies are to be free from defects in workmanship and materials under normal operating conditions. No other product in this machine is hereby covered. Sellers sole liability in the event a warranted part described above fails shall be, at its option, to replace or repair the defective part during the warranty period. For warranty claims, contact your SEGA Distributor. Should the seller determine, by inspection that the problem was caused by accident, misuse, neglect, alteration, improper repair, installation or testing, the warranty offered will be null and void.

Under no circumstances is the seller responsible for any loss of profits, loss of use, or other damages. This shall be the exclusive written Warranty of the original purchaser expressed in lieu of all other warranties expressed or implied. Under no circumstances shall it extend beyond the period of time listed above.

PARTS WARRANTY POLICY

Sega Amusements USA, Inc. warrants all parts to be free from defective materials and workmanship for a period of thirty (30) days from Sega Amusements USA, Inc. invoice date unless otherwise specified in writing by Sega Amusements USA, Inc.

This limited warranty is invalid for any part that upon examination, is deemed to have been subject to misuse, improper repair or installation, neglect or violation of specification or other instructions published by Sega Amusements USA, Inc. There are no additional warranties described above.

The limited warranties described above shall be in lieu of any other warranty, express or implied, including but not limited to any implied warranty of merchantability or fitness for a particular purpose.