



TWO PLAYER
HORIZONTAL MONITOR

ALIENS

INSTRUCTION MANUAL

Service #

708-215-5100

Jerry Korbecki ext. 122 Paul Sawicki ext. 123

ALIENS™ 1986, 1990 Twentieth Century Fox Film Corporation.
All Rights Reserved

 **KONAMI**® is a trademark of Konami Industry Co., Ltd.

Aliens is a registered trademark of Konami, Inc. ©1990 Konami Inc.



Part Number 875400

ALIENS KIT CONTENTS

Quantity	Part #	Description
1	875003	Aliens PCB
1	875100	Aliens Control Panel Overlay
1	875101	Aliens Player Instruction
1	875200	Aliens Marquee
2	875300	Aliens Top Side Decal
1	875301	Aliens Right Side Decal
1	875302	Aliens Left Side Decal
1	875400	Aliens Instruction Manual
1	875700	Aliens C.R.T. Bezel
2	30110	Red Button
2	30111	White Button
2	30112	Blue Button
6	30202	Switch Holders
6	30250	Palnuts
1	30304	Red Joy Stick
1	30305	Blue Joy Stick
1	40310	Marquee Plexiglass
1	40605	FCC Cage
1	40608	Kit Box
1	40904	Kit Wire Harness

PUTTING YOUR BEST GAME FORWARD

PREPARATION:

For best results, all old graphics should be removed completely from the cabinet. "Stick-on" graphics can be removed by using a hairdryer or hot air device. The heat from the dryer will loosen the adhesive, allowing you to easily peel them off—any adhesive residue can be cleaned off with acetone and a soft dry cloth. (DO NOT USE ACETONE ON SURFACES PAINTED WITH FLAT PAINT.)

TOOLS YOU NEED:

1. Foaming Aerosol (such as "Windex").
2. Soft Squeegee.
3. X-Acto Knife.

SIDE PANEL DECALS

1. Spray area of cabinet where Side Panel decals are to be applied with foaming aerosol or a mild soap solution.
2. Remove protective backing from decals.
3. Position decals into place.
4. With a soft squeegee, beginning from the center of the decal, slowly and evenly press out excess foam until you achieve a smooth finish.
5. Allow to set approximately 2 to 3 hours before handling. Maximum adherence is achieved in 48 to 72 hours.

6. Trim side decal to fit your cabinet.

CONTROL PANEL OVERLAY:

1. Refer to Recommended Control Panel Layout.
2. Drill any new holes needed.
3. Plug any holes that will not be used. (A permanent epoxy-filler works well for this step.)
4. Pre-position the overlay prior to removing the backing.
5. Slowly apply the overlay — inch by inch on the control panel, removing the backing as you apply it.
6. Once it's in place, by using an X-Acto knife, cut around the button and joystick placements.

INSTRUCTION/BUTTON DECALS:

Apply the Player Instruction, Button and 1 Player/2 Player decals in their respective positions. Apply pressure liberally. Allow to set as long as possible before putting game on location.

NOTE: Maximum adherence is achieved in 48 to 72 hours.

MARQUEE

(WEAR PROTECTIVE GLASSES WHILE TRIMMING MARQUEE)

1/8" Acrylic Marquee should be cut to fit your game. DO NOT remove protective mask until this is done.

One way of cutting your Marquee is as follows: (Be sure to protect painted side of Marquee from any surface which may scratch or mar finish).

CUTTING WITH A KNIFE OR SCRIBER:

Acrylic sheet up to 3/16" thick may be cut by a method similar to that used for cutting window glass. Use a scribe of some kind — a scribing knife such as the one pictured, a metal scribe, an awl, or even a sturdy craft knife — to score the sheet. Draw the scribe several times (7 or 8 times for a 3/16" thick piece) along a straight edge held firmly in place. It is best not to remove the protective masking. Make the cuts carefully using firm, even pressure. For best results make each stroke cleanly off the edge of the sheet.

Then clamp the acrylic sheet or hold it rigidly under a straight edge with the scribe mark hanging just over the edge of a table. Protect your hands with a cloth, and apply a sharp downward pressure to the other side of the sheet. It will break along the scratch. Scrape the edges to smooth any sharp corners. This method is not recommended for long breaks or thick material.

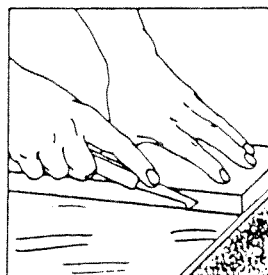

Always draw the scribing knife along a straight edge.

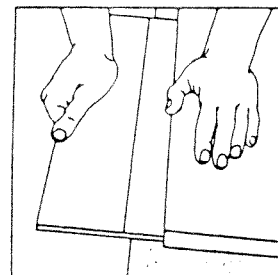

Break sheet over edge of table after scribing.

P.C.B. CAGE INSTALLATION

Konami, Inc. now supplies a new style P.C.B. cage which is superior to old style cages because of ease of installation. The cage is made of a 32 point stem-stock which is fire retardant.

TO INSTALL THE CAGE:

1. Open cage bottom and secure to desired P.C.B. position.
2. Install printed circuit board inside cage using wood screws, screwed through the cage bottom into cabinet side.
3. Close the cage over printed circuit board and secure with latch on cage.

ALIENS TECHNICAL INFORMATION

Aliens requires horizontally mounted monitor. It also generates composite negative sync. If your monitor is composite positive sync, you will have to change to composite negative sync.

To alternate composite positive sync to composite negative sync, use 7404 IC or 74LS04 IC. The signal on the output pin from the P.C.B. is a combination of H-sync and V-sync.

NOTE: Please refer to Figure 2.

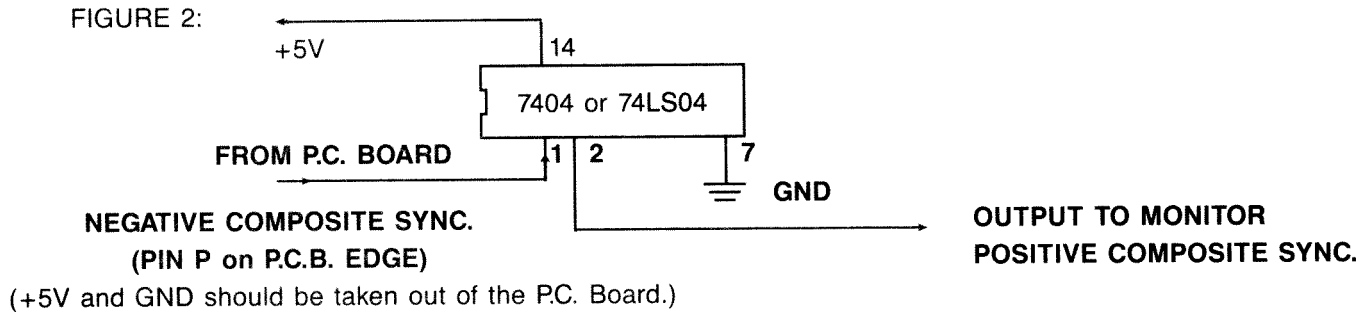

TROUBLE SHOOTING GUIDE

PROBLEM:	POSSIBLE SOLUTION
No Screen or Constant Reset	<ol style="list-style-type: none"> 1). Check +5V line at the P.C.B. Adjust if necessary. 2). Make sure all socketed eproms and custom IC's are seated securely. Apply light pressure to secure. 3). Check harness to be sure it is not on backwards.
No Sound	<ol style="list-style-type: none"> 1). Check +12V line at the P.C.B. 2). Make sure both speaker out wires are connected to the speakers. (DO NOT CONNECT A GROUND.)
Distorted Sound	<ol style="list-style-type: none"> 1). Replace cabinet speaker.
I/O Problem (coin 1 doesn't work or Joystick Up doesn't work, etc.)	<ol style="list-style-type: none"> 1). Do not hook a coin counter to the coin 1 or coin 2 outputs. This will cause damage. 2). Check your schematic for the 74LS253 IC that corresponds to your I/O problem. Check the appropriate pin with a scope or multimeter for a high output (5V), if output is low replace the 74LS253.

CAUTION

DO NOT WIRE COIN COUNTERS TO THE COIN 1 OR COIN 2 OUTPUTS. THIS WILL CAUSE DAMAGE TO THE I/O MICROCHIP 74LS253. COIN COUNTERS CAN ONLY BE WIRED TO COIN COUNTER OUTPUTS.

MONITOR INFORMATION

SERVICE INSTRUCTIONS

NOTE: All monitors are equipped with automatic degaussing coils (L701) which demagnetize the picture tube every time the monitor is turned on after being off for a minimum of 5 minutes. Should any part of the chassis become magnetized it will be necessary to degauss the affected area with a manual degaussing coil. Move the coil slowly around the CRT face and all surrounding metal parts. Then slowly withdraw for a distance of 6 feet before turning off.

1.0 BLACK LEVEL CONTROL ADJUSTMENT

This control has been set at the factory and should not need further attention, however, when the game is connected a slight adjustment of VR201 may be necessary to obtain the proper black level (the black portion of the picture just extinguished).

2.0 VERTICAL SIZE (HEIGHT)

Location of this control is shown in Fig. 1. This control must be adjusted slowly, if necessary, until the picture or test pattern attains the correct vertical proportions.

3.0 CIRCUIT PROTECTION

A 4.0A pigtail fuse, mounted on the Main Board has been provided to protect the Power Output Circuit.

4.0 FOCUS

Adjust the focus control, located on the HV unit (T352), for maximum over-all definition and fine picture detail.

5.0 HORIZONTAL HOLD CONTROL ADJUSTMENT, VR351 (See Fig. 1)

A warm-up period of at least five minutes should be allowed before alignment is carried out. With the monitor being driven from the game signal, short TP601 to TP31. Adjust VR351 until the picture stops sliding horizontally. Remove the short.

6.0 HORIZONTAL VIDEO POSITION

If the video is off center on the raster some compensation can be made by adjusting this control.

7.0 VERTICAL RASTER POSITION ADJUSTMENT

If the video is off center vertically, (short dimension of picture tube) some compensation can be made by moving the vertical raster position adjustment jumper to either positions "U" or "D".

8.0 HORIZONTAL RASTER POSITION ADJUSTMENT

If the video is off center horizontally (long dimension of the picture tube) some compensation can be made by moving the horizontal raster position adjustment jumper to either positions "R" or "L".

9.0 HORIZONTAL WIDTH ADJUSTMENT

The horizontal width coil is a hexagonal tuning tool adjustment. This control must be adjusted slowly, if necessary, until the picture or test pattern attains the correct horizontal proportions.

* KONAMI GAMES ARE ALL NEGATIVE COMPOSITE SYNC. USE THE THREE PIN CONNECTOR ON THE MONITOR.

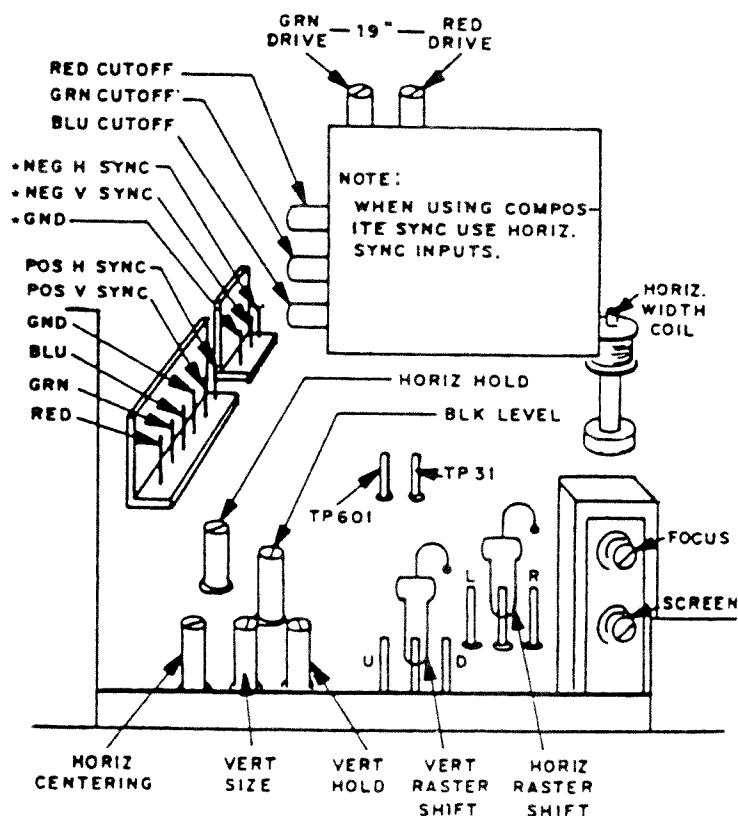

FIGURE 1

ALIENS DIP SWITCH SETTINGS

DIP SWITCH NO. 1 SETTINGS

1. COIN SWITCH NO. 1 SETTINGS

SW	1	2	3	4	COIN	CREDIT
○	OFF	OFF	OFF	OFF	1	1
	ON				1	2
	OFF	ON			1	3
	ON				1	4
	OFF	OFF	ON	OFF	1	5
	ON				1	6
	OFF	ON			1	7
	ON				2	1
	OFF	OFF	OFF	ON	2	3
	ON				2	5
	OFF	ON			3	1
	ON				3	2
	OFF	OFF	ON	ON	3	4
	ON				4	1
	OFF	ON			4	3
	ON				FREEPLAY	

FREEPLAY: You can play games without coins.

2. COIN SWITCH NO. 2 SETTINGS

SW	5	6	7	8	COIN	CREDIT
○	OFF	OFF	OFF	OFF	1	1
	ON				1	2
	OFF	ON			1	3
	ON				1	4
	OFF	OFF	ON	OFF	1	5
	ON				1	6
	OFF	ON			1	7
	ON				2	1
	OFF	OFF	OFF	ON	2	3
	ON				2	5
	OFF	ON			3	1
	ON				3	2
	OFF	OFF	ON	ON	3	4
	ON				4	1
	OFF	ON			4	3
	ON				VOID	

DIP SWITCH NO. 2 SETTINGS

1. THE NUMBER OF PLAYER'S LIFE

SW	1	2	NUMBER
○	OFF	OFF	1
	ON		2
	OFF	ON	3
	ON		5

2. DIFFICULTY OF THE GAME

SW	6	7	DIFFICULTY
○	OFF	OFF	EASY
	ON		NORMAL
	OFF	ON	DIFFICULT
	ON		VERY DIFFICULT

3. SOUND IN ATTRACTIVE MODE

SW	8	SOUND
○	OFF	OFF
	ON	ON

SW3, 4, 5 are not used.

DIP SWITCH NO. 3 SETTINGS

1. VIDEO SCREEN FLIP

SW	1	SCREEN
○	OFF	NORMAL
	ON	UPSIDE DOWN

2. CHANGE OF MODE

SW	3	MODE
○	OFF	GAME
	ON	TEST

SW2, 4 are not used.

○ Shows recommended settings.

ALIENS KIT WIRING DIAGRAM

Solder Side ← → Parts Side

WIRE COLOR KEY:

BLACK	GND	A	1	GND	BLACK
BLACK	GND	B	2	GND	BLACK
RED	+5V DC	C	3	+5V DC	RED
RED	+5V DC	D	4	+5V DC	RED
BLUE	NOT USED	E	5	NOT USED	BLUE
ORANGE	+12V DC	F	6	+12V DC	ORANGE
	*KEY	H	7	*KEY	
WHITE/RED	COIN COUNTER 2	J	8	COIN COUNTER 1	WHITE/BLACK
	(EMPTY)	K	9	(EMPTY)	
RED/BLACK	SPEAKER	L	10	SPEAKER	RED/YELLOW
	(EMPTY)	M	11	(EMPTY)	
GREEN	VIDEO GREEN	N	12	VIDEO RED	RED
WHITE	VIDEO SYNC	P	13	VIDEO BLUE	BLUE
WHITE/ORANGE	SERVICE SW	R	14	VIDEO GROUND	BLACK
BLACK/WHITE	(EMPTY)	S	15	(EMPTY)	WHITE/BROWN
BROWN/BLACK	COIN 2	T	16	COIN 1	YELLOW/BLACK
RED/WHITE	2P START	U	17	1P START	RED
BLUE/WHITE	2P UP	V	18	1P UP	BLUE
GREEN/WHITE	2P DOWN	W	19	1P DOWN	GREEN
ORANGE/WHITE	2P LEFT	X	20	1P LEFT	ORANGE
YELLOW/WHITE	2P RIGHT	Y	21	1P RIGHT	YELLOW
BROWN/WHITE	2P SHOOT 2	Z	22	1P SHOOT 1	BROWN
VIOLET/WHITE	2P SHOOT 2	a	23	1P SHOOT 2	VIOLET
GRAY/WHITE	NOT USED	b	24	NOT USED	GRAY
	NOT USED	c	25	NOT USED	
	NOT USED	d	26	NOT USED	
BLACK	GND	e	27	GND	BLACK
BLACK	GND	f	28	GND	BLACK

(BASE COLOR/LINE COLOR)

WIRING DIAGRAM

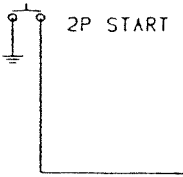
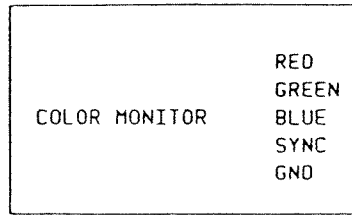
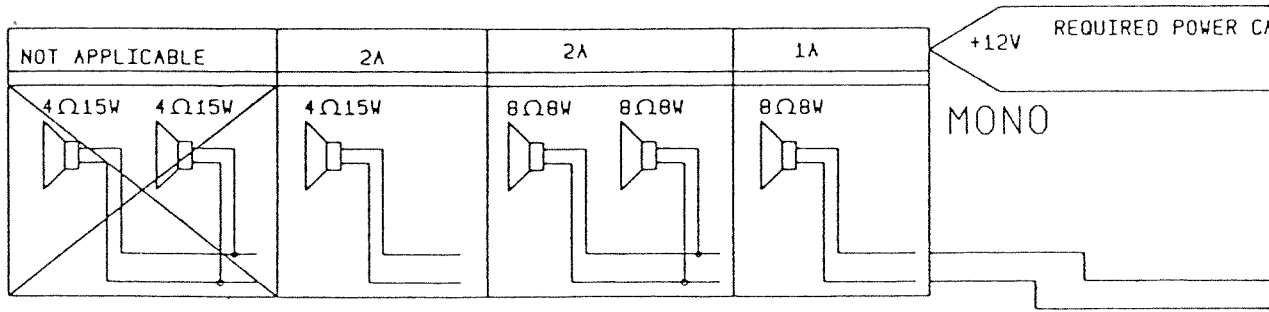

CONTROL FOR 2P

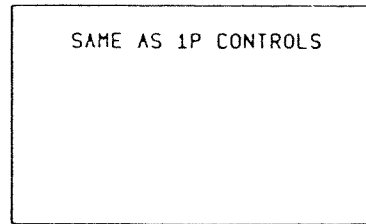

CONTROL FOR 1P

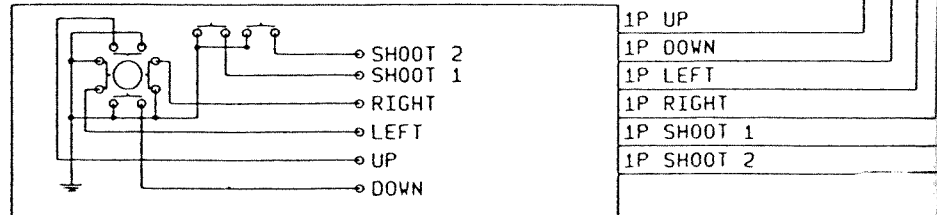

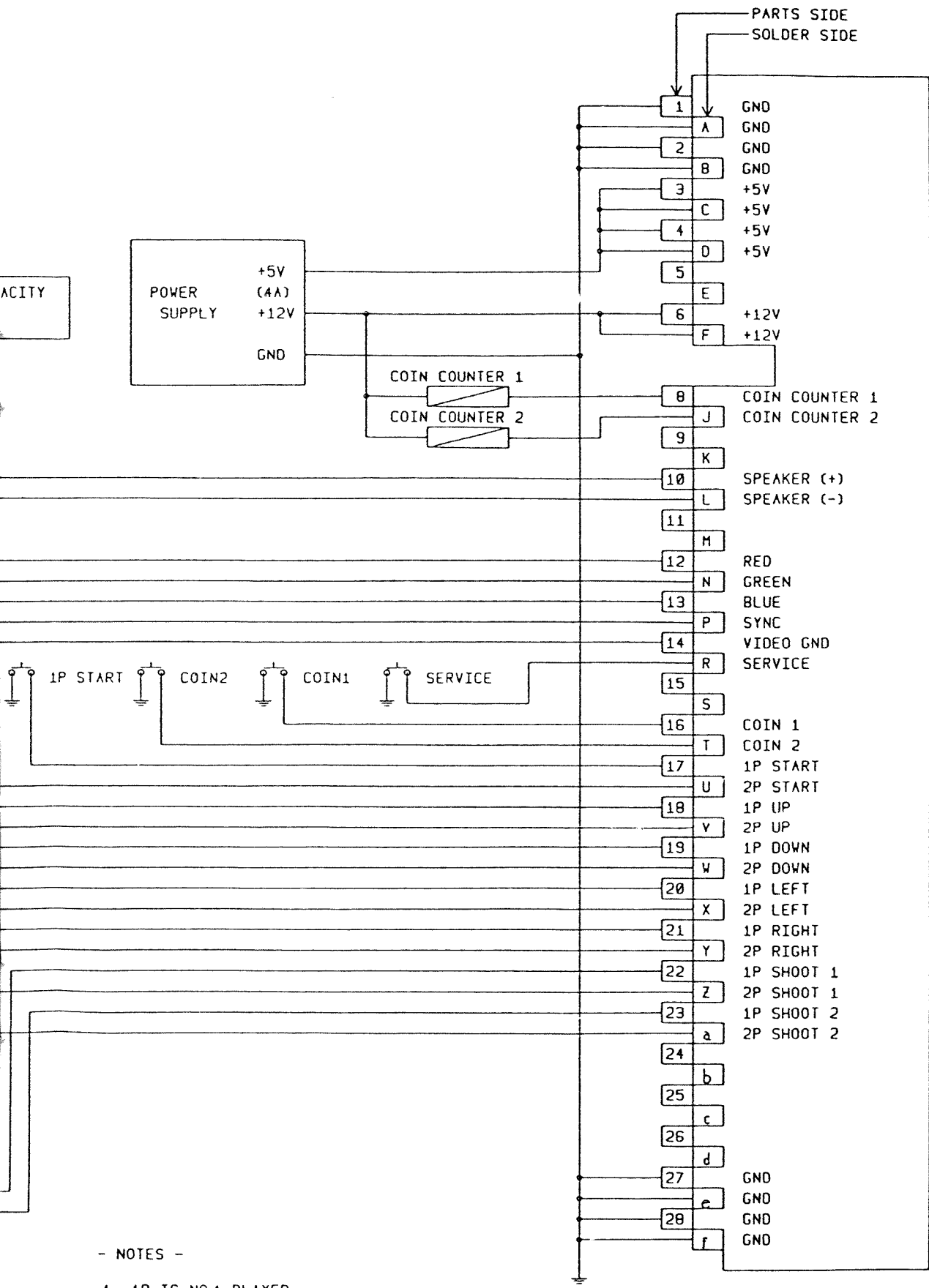

- NOTES -

- 1 1P IS NO.1 PLAYER
- 2 2P IS NO.2 PLAYER
- 3 SURGE KILLER DIODES FOR COIN COUNTER INSTALLED ON P.C.B

JAMMA 56PIN EDGE CONNECTOR
5/32 INCH PITCH

ALIENS UPRIGHT VERSION ONLY: WIRING HARNESS

WIRE COLOR KEY:

Solder Side ← → Parts Side

BLACK	GND	A	1	GND	BLACK
BLACK	GND	B	2	GND	BLACK
RED	+5V DC	C	3	+5V DC	RED
RED	+5V DC	D	4	+5V DC	RED
	NOT USED	E	5	NOT USED	
ORANGE	+ 12V DC	F	6	+ 12V DC	ORANGE
	*KEY	H	7	*KEY	
BROWN/YELLOW	COIN COUNTER 2	J	8	COIN COUNTER	GREEN/GRAY
	(EMPTY)	K	9	(EMPTY)	
YELLOW	SPEAKER	L	10	SPEAKER (+)	BLUE
	(EMPTY)	M	11	(EMPTY)	
WHITE/GREEN	VIDEO GREEN	N	12	VIDEO RED	RED/WHITE
WHITE	VIDEO SYNC	P	13	VIDEO BLUE	BLUE/WHITE
	(EMPTY)	R	14	VIDEO GROUND	BLACK
	(EMPTY)	S	15	(EMPTY)	
VIOLET/WHITE	COIN 2	T	16	COIN 1	BLUE/BROWN
RED/GREEN	2P START	U	17	1P START	RED/YELLOW
BLUE/YELLOW	2P UP	V	18	1P UP	ORANGE/WHITE
VIOLET/YELLOW	2P DOWN	W	19	1P DOWN	BLACK/WHITE
ORANGE/GREEN	2P LEFT	X	20	1P LEFT	RED/GRAY
ORANGE/YELLOW	2P RIGHT	Y	21	1P RIGHT	GRAY/WHITE
BLACK/YELLOW	2P SHOOT 2	Z	22	1P SHOOT 1	RED/WHITE
ORANGE/GRAY	2P SHOOT 2	a	23	1P SHOOT 2	GREEN/BROWN
	NOT USED	b	24	NOT USED	
	NOT USED	c	25	NOT USED	
	NOT USED	d	26	NOT USED	
BLACK	GND	e	27	GND	BLACK
BLACK	GND	f	28	GND	BLACK

(BASE COLOR/LINE COLOR)

ALIENS UPRIGHT VERSION ONLY: AC FLOW CHART

- 1. GREEN/YELLOW
- 2. BLACK
- 3. RED
- 4. BLUE
- 5. BROWN
- 6. RED/BLACK
- 7. BLACK/WHITE
- 8. WHITE
- 9. GREEN
- 10. VIOLET
- 11. ORANGE

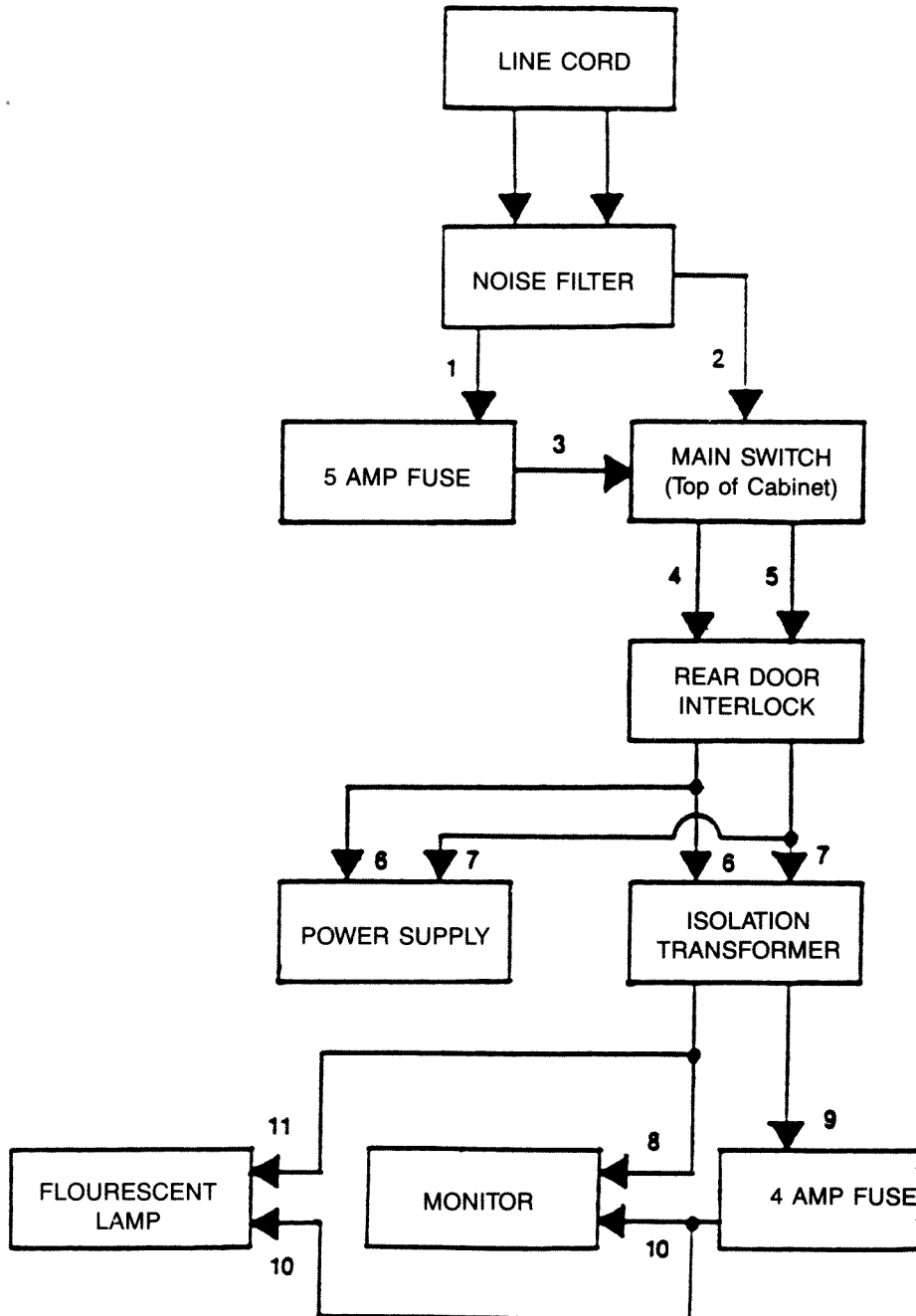

ALIENS TECHNICAL INFORMATION

TECHNICAL INFORMATION

- (1) Required power capacity
GND-Vcc 5V 5A or more
GND-(+12V)
*See the Wiring Diagram.
- (2) Output
R (red) analog, positive
G (green) analog, positive
B (blue) analog, positive
SYNC. H-V complexed, negative
- (3) The monitor should be horizontally installed.
- (4) Use the volume knob on the PCB to adjust sound level.
Turn the knob clockwise and it becomes louder.
- (5) Handle with care.

RECOMMENDED CONTROL PANEL LAYOUT

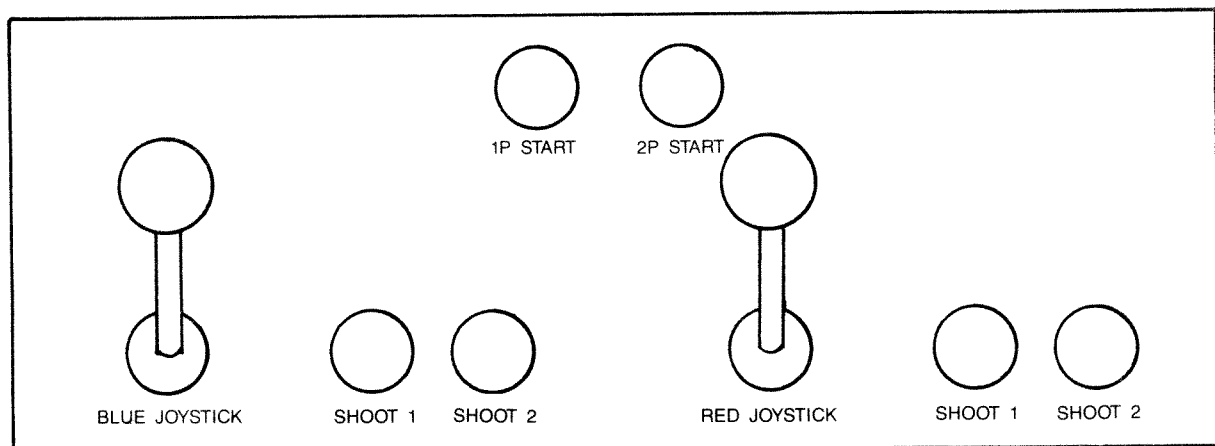

CONTROL PANEL DRILLING TEMPLATE

Button Hole Size 1-3/16 Inch

Use this Template for Player 1 and Player 2 Controls



JOYSTICK

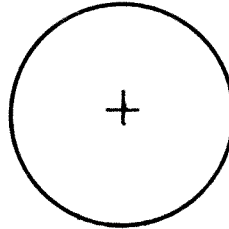

SHOOT 1

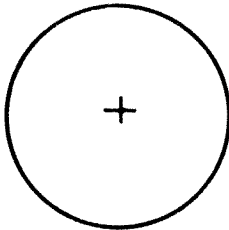

SHOOT 2

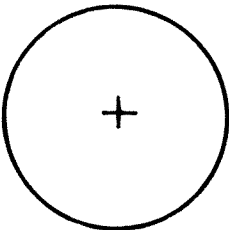

USER INFORMATION
WARNING
F.C.C. REGULATION COMPLIANCE

THIS KIT IS INTENDED FOR USE ONLY ON COIN-OPERATED VIDEO GAMES MANUFACTURED AFTER OCTOBER 1, 1983 WHICH HAVE BEEN VERIFIED FOR COMPLIANCE WITH REQUIREMENTS IN PART 15 OF F.C.C. RULES FOR A CLASS A COMPUTING DEVICE.

IMPROPER CONNECTION OF THIS KIT OR CONNECTION TO ANY OTHER GAME NOT SO MANUFACTURED OR VERIFIED FOR COMPLIANCE MAY CAUSE UNACCEPTABLE INTERFERENCE TO RADIO AND TV. RECEPTION, REQUIRING THE OPERATOR TO TAKE WHATEVER STEPS ARE NECESSARY TO CORRECT THE INTERFERENCE.

THE P.C. BOARD CAGE SUPPLIED WITH THIS CONVERSION KIT MUST BE UTILIZED AND TERMINATED TO GROUND AT THE TIME OF INSTALLATION.



900 Deerfield Parkway, Buffalo Grove, 60089-4510
Telephone: (708) 215-5100, Telex: 6871385 KONAM UW, Fax: (312) 215-5122