

# KIT MANUAL



## OPERATIONS MANUAL

Including:

Game Operation & Adjustment  
Game Testing & Problem Diagnosis  
Parts Information  
Reference Diagrams & Schematics

WILLIAMS ELECTRONICS GAMES, INC.  
3401 N. California Avenue  
Chicago, IL 60618



**OFFICIAL**™  
**VH**

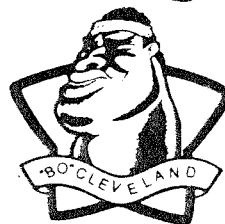

## Table of Contents

### **Section 1: Kit Installation, Operation & Troubleshooting**

<b>Safety</b> .....	1-2
<b>Conversion Instructions</b>	
Inspection.....	1-3
Recommended Tools.....	1-3
Cabinet Modifications.....	1-4
Control Panel Modifications.....	1-4
Installing PC Boards into a JAMMA Game Cabinet.....	1-7
Installing PC Boards into a NON-JAMMA Game Cabinet.....	1-8
<b>Game Features</b>	
Starting-up.....	1-9
Player Controls.....	1-9
Typical Control Panel Layout.....	1-9
<b>Game Operation-</b>	
Control Switches.....	1-10
<b>Game Adjustments and Diagnostics</b>	
Rules & General Information.....	1-11
DIP Switch Table.....	1-10
<b>Troubleshooting</b> .....	1-14

### **Section 2: Diagrams & Schematics**

CPU Board Layout.....	2-1
CPU Schematic.....	2-2
Coin Switch & Meter Wiring Diagram.....	2-15
JAMMA Chart.....	2-16
Cabinet Wiring Diagram.....	2-17
Control Panel Template Diagram(s).....	2-18

# HIT THE ICE KIT

S E C T I O N  
O N E

---

---

Installation & Operation

# Safety Notices

The following safety hints apply to all kit operators and service personnel. Specific warnings and cautions will be found throughout this manual where they apply. We recommend that you read this page, and also all of Section 1, before preparing your kit for play.

## NOTICE: SALVAGED PARTS

Parts salvaged from old games are required to complete your kit. These salvaged parts must operate perfectly; otherwise, the converted game cannot perform properly or safely. Always repair circuit board malfunctions and cabinet damage before conversion is attempted.

## NOTICE: POWER SUPPLY

Be sure the power supply from your old game is capable of +5V dc at 5A, -5V dc at 1A and +12V at 1A. These operating voltages are necessary for your kit. Your power supply must be FCC approved.

## NOTICE: MONITOR

This kit is not intended for use with X-Y monitors. Suitable monitors have horizontally mounted CRTs and raster electronics with inputs for red, green and blue video, as well as composite Negative Sync inputs.

## NOTICE: COIN MECHANISM

Be sure to clean and lubricate your old coin mechanisms. Servicing them is crucial to your game's earning potential and operation.

## NOTICE: COIN METERS

Coin meters are not provided with this kit. Wiring information is provided as a convenience to the operator.

## NOTICE: SERVICING, INSTALLING

Always turn your game OFF and unplug it before attempting to service or install your kit.

## CAUTION

**PROPERLY ATTACH ALL CONNECTORS.** *Be sure that the connectors on each printed circuit board (PCB) are properly connected. If they do not slip on easily, do not force them. A reversed connector may damage your kit and void the warranty. All connectors are keyed to fit specific pins on each board.*

---

---

# Conversion Procedure

## Inspection

Unpack the materials from the carton and inspect for obvious signs of damage. Use this checklist to be sure your kit is complete.

Part No.	Item	Quantity
( ) C-9241-1	Button Assy. Blue	2
( ) C-9241-4	Button Assy. Red	2
( ) C-9241-5	Button Assy White	8
( ) H-14272	Player 3/4 Cable	1
( ) 03-6047-2	Spacer 3/8	4
( ) 16-30203-101	Manual	1
( ) 16-9191	Template Controls	1
( ) 16-9191-1	Player 2 Cntrl. Pnl. Template	1
( ) 16-9191-2	Player 3 Cntrl. Pnl. Template	1
( ) 16-9191-3	Player 4 Cntrl. Pnl. Template	1
( ) 20-9222	Pinnut 5/8	12
( ) 20-9319-1	8 Way Wico Joystick - Red	2
( ) 20-9319-9	8 Way Wico Joystick - Blue	2
( ) 20-9457	Button Holder w/Switch	12
( ) 31-1480-30203	Marquee Kit	1
( ) 31-1482-30203	Decal Set Kit	2
( ) 31-1612-30203	Control Panel Kit	1
( ) 4308-01123-20B	Carg. Bolt 8-32x1-1/4	16
( ) 5901-12734-00	CPU Assy. Hit The Ice	1
( ) Assorted Hardware		

## Recommended Tools and Supplies

- ( ) black semi-gloss paint
- ( ) electric drill
- ( ) electric screwdriver
- ( ) grease pencil or marker
- ( ) hex driver
- ( ) 180 grit sandpaper or electric sander
- ( ) pliers
- ( ) razor knife
- ( ) soldering iron and solder
- ( ) wire cutters
- ( ) black electrical tape
- ( ) quick-hardening wood putty

## **Cabinet Modifications**

1. Fill in gouges with a good quick-hardening wood putty. Sand cabinet and wipe it clean.
2. Repaint the cabinet with black semi-gloss paint (Games wood grain sides: remove the old decals and clean the glue residue from the old decal before painting). Allow paint to dry completely.
3. Pencil a line roughly at the top of the old graphic. Lightly moisten the cabinet with soapy water. Apply the decal starting at the top and working down. After the decal is in place, use a piece of the foam packaging as a squeegee and smooth the decal down, taking care to squeeze out the air bubbles. If you miss an air bubble, pop it with a razor blade or a pin and burnish it down. Allow 12 hours for the adhesive in the decals to set. Remove masking.
4. Check the HIT THE ICE KIT for an FCC sticker and apply it over the existing sticker on the cabinet. When Williams ships a game, it is in compliance with FCC regulations. Your sticker is proof. If the sticker is missing or damaged, legal repercussions to the owner or distributor of the game may result. If your game kit does not contain an FCC sticker, call Williams Electronics Games, Inc. immediately.
5. Apply the Instructions (Card or Decals) to the CRT viewing glass.

## **Control Panel Modifications**

1. Remove the control panel buttons and joysticks and remove the old vinyl covering.
2. Place the template on the control panel and use it to help you design your control panel. You will need to use the appropriate Mounting Template(s) for each player. There are (4) templates included in the set. For a 4 player kit simply layout each template as shown on the following page. Please note alternate the layout for a 2 player kit as shown on the following page.

### 4 - PLAYER CONVERSION KIT

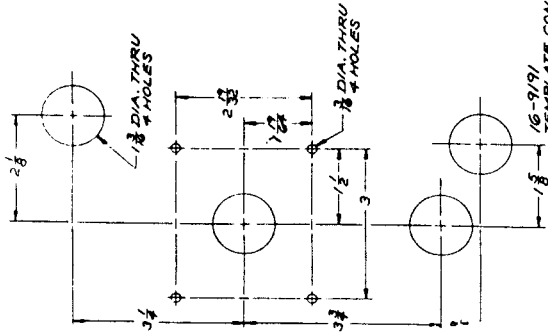

16-9/91-1  
TEMPLATE CONTROLS  
PLAYER #1  
USED ON 30203 KIT

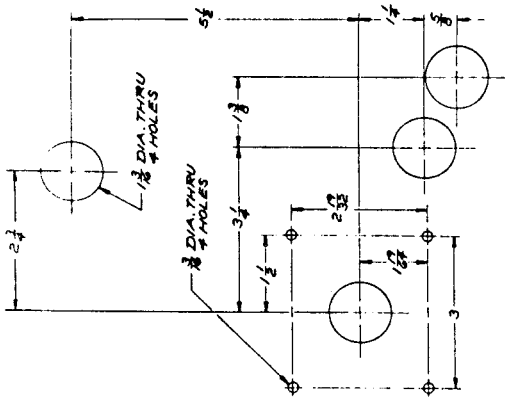

16-9/91-2  
TEMPLATE CONTROLS  
PLAYER #2  
USED ON 30203 KIT

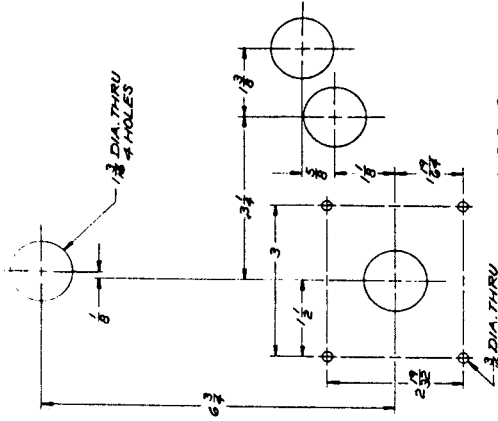

16-9/91-3  
TEMPLATE CONTROLS  
PLAYER #3  
USED ON 30203 KIT

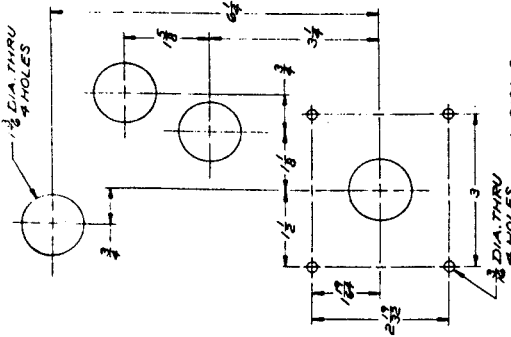

16-9/91-4  
TEMPLATE CONTROLS  
PLAYER #4  
USED ON 30203 KIT

### 2 - PLAYER CONVERSION KIT

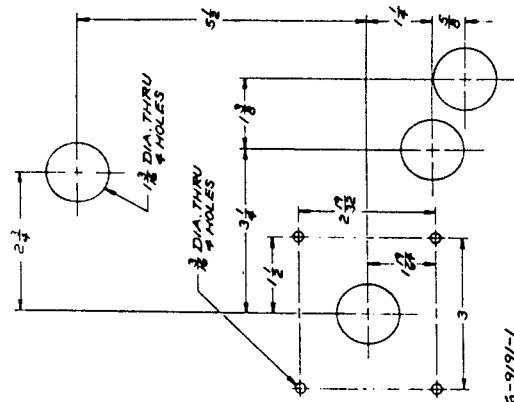

16-9/91-1  
TEMPLATE CONTROLS  
PLAYER #1  
USED ON 30203 KIT

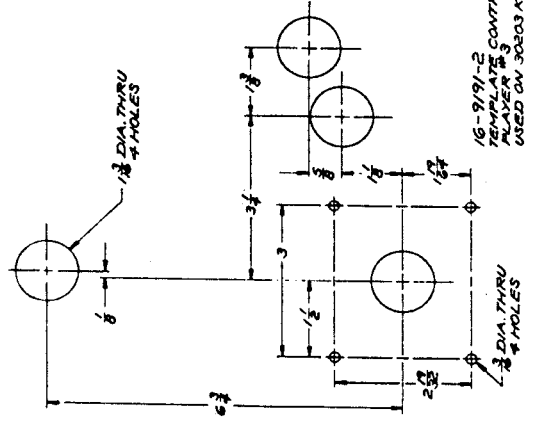

16-9/91-2  
TEMPLATE CONTROLS  
PLAYER #2  
USED ON 30203 KIT



3. Drill holes as needed for the joysticks and buttons. Plug previous holes with wood blocks, putty, cardboard or epoxy. File the new holes smooth.
4. Carefully remove the backing on the vinyl control panel overlay (user provided, not included in kit). Place the overlay on top of the control panel. Prevent air bubbles from getting under the vinyl overlay.
5. a) After the overlay is on securely, use a razor knife to cut holes for the buttons and joysticks.  
b) Position the stickers around the appropriate button locations. Refer to the Typical Control Panel Layout diagram on the previous page for suggested button and joystick locations.  
c) Peel the backing from the adhesive on the clear protective overlay. Position the overlay so that it covers the stickers and press it into place. Use a razor knife to cut holes for the joystick and buttons.
6. To mount the pushbuttons and button-holder/switch to the control panel, push the threaded end of the pushbutton through the control panel from the top so that the threads extend through the back of the control panel. Then, take the white plastic button holder/switch and place it over the pushbutton threads so that the threads extend through the hole in the holder. The blade switch must point toward the back of the cabinet and face you. Secure into place with a palnut. Repeat for all of the pushbutton switches.
7. The joystick must be disassembled before mounting it to the control panel.

## Installing the PC Boards and Wiring into a JAMMA Game Cabinet

### Caution

Properly insulate any unused wires within the JAMMA Cable.

1. Disconnect and remove the existing video board in the JAMMA Game Cabinet.
2. Mount the HIT THE ICE KIT video board inside the JAMMA Game Cabinet where the old video board was located
3. If you choose to use the JAMMA Cable provided with the kit, unsolder your old JAMMA cable from the speaker, power supply, control panel switches (which may already be disconnected) and coin door. Remove the cable from the game. If you are not going to use the JAMMA Cable provided with the kit, check the JAMMA Cable Connector Chart to be sure your cable is compatible. Leave your power supply chassis as is.
4. Connect the JAMMA Cable to J1 on the HIT THE ICE KIT video board. Using the JAMMA Cable Connector Chart for reference, solder the correct JAMMA Cable wires to the speaker, power supply, control panel switches and coin door.
5.
  - a) For a (4) player conversion, wire the player 3/4 cable from players 3 & 4 control panel joysticks & buttons to connectors 3P & 4P on the CPU Board. (see drawing below)
  - b) For a (2) player conversion, ignore above (a) and proceed.
6. Place the FBI Warning Label on the inside of the cabinet next to the PC boards. Be sure the label is completely visible.

### HIT THE ICE CPU BOARD

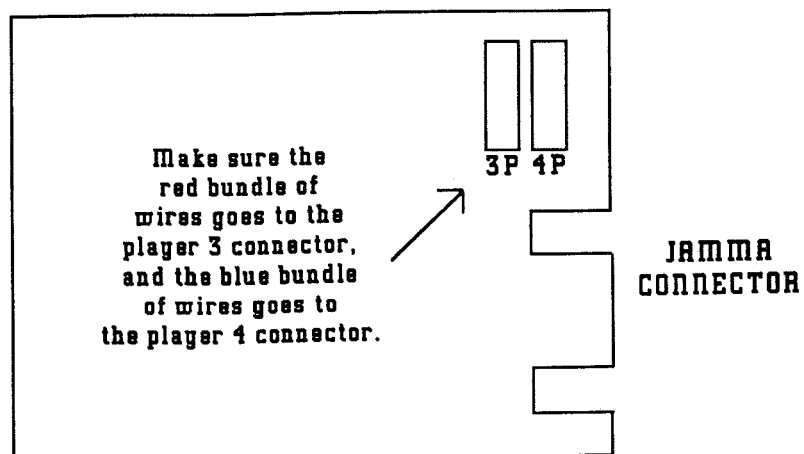

## Installing the PC Boards and Wiring into a NON-JAMMA Game Cabinet

**NOTE: IF YOU NEED A JAMMA MAIN HARNESS PLEASE CONTACT YOUR AUTHORIZED WILLIAMS' DISTRIBUTOR. (JAMMA MAIN HARNESS PART # H-13411)**

1. Disconnect and remove the existing video board in the JAMMA Game Cabinet.
2. Mount the HIT THE ICE KIT video board inside the JAMMA Game Cabinet where the old video board was located
3. Leaving several inches of wire, cut the wires at the coin door, control panel switches (which may already be disconnected) speaker and power supply.
4. Connect the JAMMA Cable to J1 on the HIT THE ICE KIT video board. Follow the JAMMA Cable Connector Chart and splice the wires of the JAMMA Cable to the existing wires for the coin door, power supply, speaker and control panel. Be sure all of the spliced wires are well insulated with black electrical tape.
5. a) For a (4) player conversion, wire the player 3/4 cable from players 3 & 4 control panel joysticks & buttons to connectors 3P & 4P on the CPU Board. (see drawing below)  
b) For a (2) player conversion, ignore above (a) and proceed.
6. Place the FBI Warning Label on the inside of the cabinet next to the PC boards. Be sure the label is completely visible.

### Note

Be sure all spliced wires are well insulated with black electrical tape.

### Caution

Properly insulate any unused wires within the JAMMA Cable.

### HIT THE ICE CPU BOARD

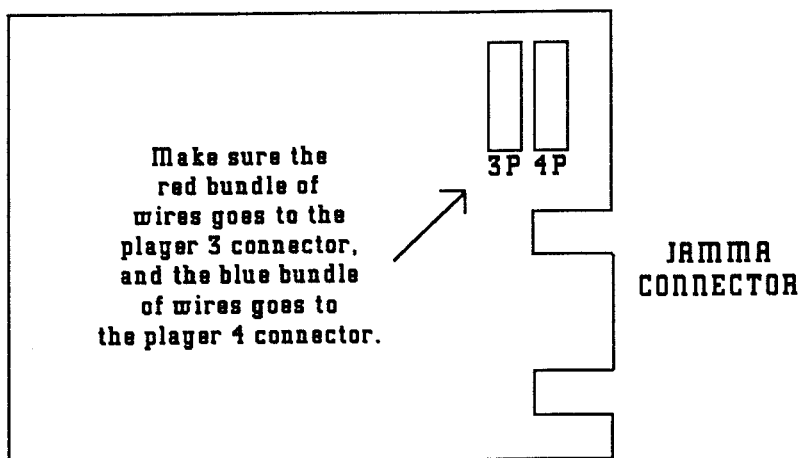

# Game Features

## Starting Up

Switch on power to the game. A "rug" pattern appears on the crt screen. The game then proceeds to go through a self-check. The game then moves to the attract mode. After the proper coinage has been inserted, the game exits the attract mode and enters the play mode.

**HIT THE ICE KIT is a two or four player game.**

## Player Controls

- Each Start button allows (1 to 4) players to begin play or continue play.
- 1 Pass/Save Button per player.
- 1 Shoot/Check Button per player.
- 1 Joystick per player.
- Find below the suggested control panel layouts for a two player kit & a four player kit.

### NOTE

When an error is detected during Start-up Tests, game start-up does not progress, and an error message appears on the screen.

### 2 PLAYER HIT THE ICE CONTROL PANEL DIAGRAM

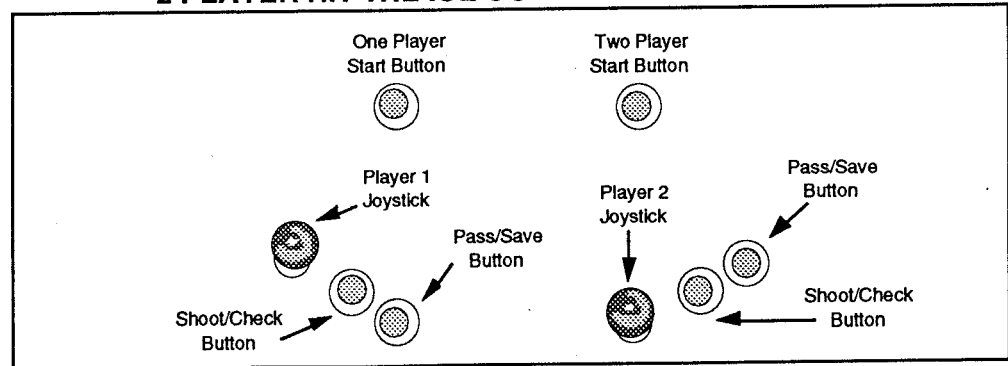

### 4 PLAYER HIT THE ICE CONTROL PANEL DIAGRAM

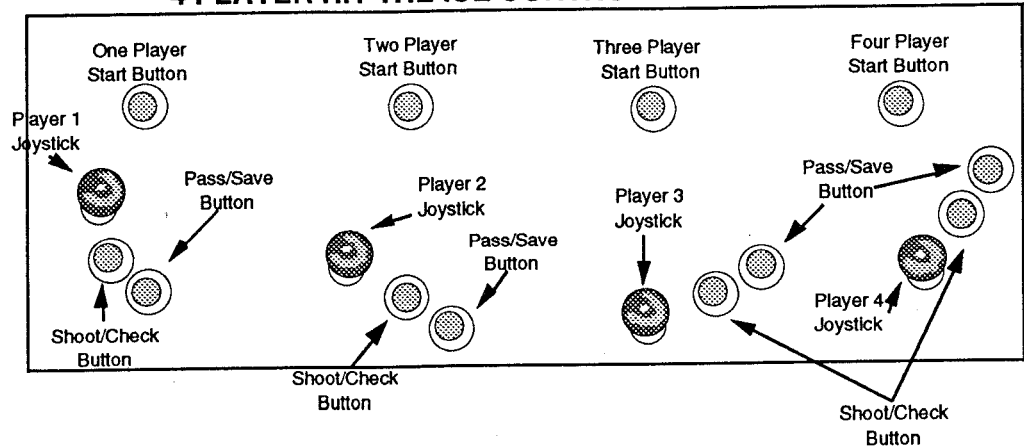

---

---

## Game Operation

HIT THE ICE is a one to four player video game with a color monitor. From the player's perspective, the game has two modes of operation: Ready-to-Play and Play. For the owner/operator, the game has a service option through the Dip Switch settings (located on Main Board, accessed through the pull-out shelf).

### Control Switches

- The **COIN DOOR SLAM TILT SWITCH** detects any forceful vibrations against the Coin Door. This eliminates pounding for free games.
- The **VOLUME CONTROL** allows increasing or decreasing the volume level of the game music and speech. For greater profits, set your game's volume level at its maximum (located on the Main Board, accessed through the pull-out shelf).
- The **TEST/DIAGNOSTICS SWITCH** is not used on this game.
- The **SERVICE CREDIT SWITCH** is a special feature switch that allots credit without affecting the game's book-keeping total.

# General HIT THE ICE Information

"Hit The Ice" is a 1 to 4 player video game based on the game of Ice Hockey. It takes place on the Official "VHL" (Video Hockey League) ice rink pitting the Reds (left side) against the Blues (right side). Each team is made up of 3 players - 2 forwards and a goaltender. The object of the game is to shoot the puck into the other team's goal. What comes to mind when you think of "Ice Hockey"? Okay. Now forget all the stuff about confusing rules, obscure penalties and stoppage of play...and what are you left with? "Hit The Ice" Delivers!

Fights, Trips, Body Slams, Shattering Glass, Blazing Shots, Head over heels bone crunching hits, Hacking, Slashing, Spearing, Elbowing all out knock down, punching, crunching action. You don't need to know how to skate to enjoy "Hit The Ice"- the ultimate red blooded sport. Fast paced end to end action, heart stopping incredible saves, booming slapshots, impossible in the air 360 degree cartwheel supershots (with some good natured humor thrown in).

"Hit The Ice" is designed for those totally unfamiliar with the traditional game of Ice hockey as well as for true fanatics of the sport. Don't think we forgot the true hockey fan either "Hit The Ice" provides crisp passing, strategic play and players who skate with finesse and speed. And if that isn't enough - we offer a power drink to each player between periods which turns you all star into an all out maniac on ice with a shot from a cannon! Power Drink-- during the locker room scene, players are offered the purchase (1 credit) of a power drink. As it says on the screen "Skate Faster, Shoot Harder, It really, Really works! A player inserts 1 credit and hits his start button to buy the drink. At the start of the next period you'll see your player undergo a wild cartoon like transformation that always gets a chuckle. And turns your player into a maniac. For the next 1:00. (Power drinks may be purchased only in the locker room.)

To speed up or skip pre game time out & locker room scenes, hold down **ANY SHOOT** button to make time run out on clock!

## 1 to 4 Player Competition

1 player game - player competes against the computer (he controls his character, his goalie, and partially his computer controlled teammate).

Two player games - players can team up against the computer or go head to head.

Players can also team up for a 3 or 4 player game.

Continuous Buy-in feature allows players to join in the game at any time.

## Game Length

The game is divided into 3 five minute periods. Players return to the locker room between each period (and at a 2:00 minute warning during the 3rd period) to get playing tips and are each offered a "Power Drink" (purchased with one credit).

# General HIT THE ICE Information Con't.

## Player Selection

Before play begins in the 1st period, players are asked to choose their goalies and the rest of their characters from a group of twelve. If they are not playing with another person on their team, the computer selects the "Hit The Ice" teammate for them.

As you move your joystick over the different characters you will see them displayed full figure at the bottom of the screen showing their unique hitting style.

Each "Hit The Ice" character has his own unique style of a "Hit".

Players begin the game with a faceoff at center ice. The player you chose has his face and name displayed at the top of the screen as the game progresses and he gets more and more beat up, you'll see it reflected in his face at the top of the screen - each major hit he takes - a new lump appears.

## Fighting

With action this intense, fights are bound to happen - players who relentlessly slam, spear, and trip each other soon drop their sticks and gloves and go at it. Two fisted fun doesn't stop the play (as there are no penalties) so play continues with the winner skating off with the puck, and the loser on the ice shaking off the cobwebs. The best time to start a fight (and when they most often occur) is after a goal is scored - drop the gloves and work out your frustrations on you opponent's face! Loss of a fight results in loss of skating speed (and sometimes the ability to stand without falling down) for the next 10 seconds of play - so there is a clear advantage to winning fights! Lose 3 fights in a row and your player is carried off the ice to be replaced by a new player!

## Player Controls (Skater)

To make a **WRIST SHOT**: Hit SHOOT Button & Hit JOYSTICK simultaneously.

To make a **SLAP SHOT**: Hold down SHOOT Button & Release, Hit JOYSTICK simultaneously.

To **"FAKE" A SHOT**: Hit SHOOT Button ONLY.

To **PASS**: Hit PASS Button.

To **REQUEST A PASS**: Hit PASS Button.

To **HIT**: Hit CHECK Button.

## Player Controls (Goalie)

To **MAKE A SAVE**: Hit SAVE Button.

To **"FREEZE" PUCK**: Catch Puck/Wait for Whistle.

To **PUNCH**: Hit CHECK Button.

To **PASS**: Hit PASS Button.

To **PUNCH**: Hit CHECK Button.

**REMEMBER: JOYSTICK CONTROLS GOALIE & SKATER**

# HIT THE ICE DIP SWITCH TABLE

## DIP SWITCH TABLE A

SETTINGS	POSITIONS	1	2	3	4	5	6	7	8							
GAME STYLE	• MAX. 4 PLAYER	OFF	OFF													
	MAX. 2 PLAYER	ON														
TEST MODE	• NORMAL GAME									OFF						
	TEST GAME									ON						
ATTRACT SOUND	• WITH											OFF				
	WITHOUT											ON				
GAME PRICING COIN 1 COIN 2	• 1 COIN 1 PLAY												OFF	OFF	OFF	OFF
	2 COIN 1 PLAY												ON			
	3 COIN 1 PLAY												OFF	ON		
	1 COIN 2 PLAYS												ON	OFF		
	1 COIN 3 PLAYS		OFF	ON												
	1 COIN 4 PLAYS		ON	OFF												
	1 COIN 5 PLAYS		ON	OFF												
	1 COIN 6 PLAYS		ON	ON												

## DIP SWITCH TABLE B

SETTINGS	POSITIONS	1	2	3	4	5	6	7	8
GAME DIFFICULTY EASY = (A) HARD = (D)	• RANK B	OFF	OFF						
	RANK A	ON							
	RANK C	OFF	ON						
	RANK D	ON							
TIMER COUNT	• 1 SEC. = 58/60			OFF	OFF	OFF			
	1 SEC. = 56/60			ON					
	1 SEC. = 62/60			OFF	ON				
	1 SEC. = 45/60			ON					
MAXIMUM CREDIT	• 9								OFF
	99								ON

(\*) = Factory Setting

NOTE: After setting Dip Switch option(s), turn game OFF then On to activate the settings.



---

---

# Troubleshooting

<b>Problem</b>	<b>Possible Solution</b>
NO PICTURE OR DISTORTED PICTURE.	Check for faulty video board or monitor. Check for disconnected video signal cable, or video extension cable.
TURN GAME ON & NOTHING HAPPENS	Check line fuse. Check for +5V dc at pins C, D, 3, and 4 of the JAMMA Connector.
NO SOUND	Check the speaker and speaker connection to pins L and 10 on JAMMA Connector. Check volume control setting. Check for +12V dc at pins F and 6 on the JAMMA Connector.
NO GENERAL ILLUMINATION	Check the 1A., S-B fuse on the floor below the coin box.
MOVE JOYSTICK, BUT PLAYER DOES NOT MOVE OR FIRE	Check for open wires between Joystick and CPU Board. Check for contamination on joystick switch contacts and CPU Board pins. Check for proper ground.
PRESS <b>START</b> <b>BUTTON</b> AND NOTHING HAPPENS	Check for open wires between button and CPU Board. Check for contamination on CPU Board pins or button switch blade contacts. Check for proper ground.
NO CREDIT GIVEN WHEN COINS ARE INSERTED	Check DIP switch coin setting. Check for contamination on coin switch contacts. Check for an open wire between Coin Switch 1 and pin 16 on JAMMA Connector or Coin Switch 2 and pin T of JAMMA Connector.
TOO MANY CREDITS FOR NUMBER OF COINS INSERTED	Check Game Pricing setting. Check for a short between pins T & 16 on JAMMA Connector.
GAME WON'T GO INTO THE TEST MODE.	Try to activate Dip Switch again (found on Main Board, access through pull-out mounting shelf).

# HIT THE ICE KIT

S E C T I O N  
T W O

---

---

Diagrams & Schematics

# Coin Switch and Meter Wiring

## Option 1

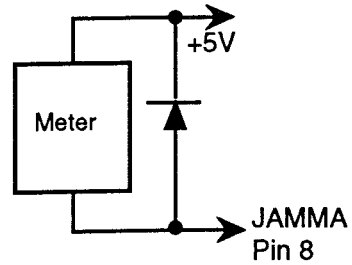
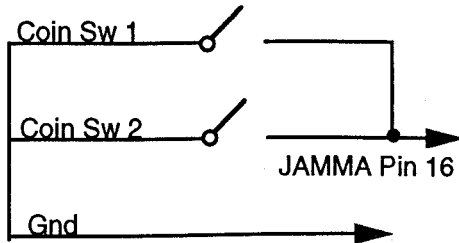

## Option 2

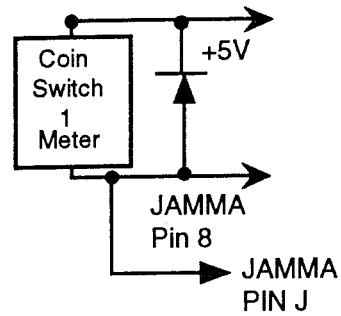
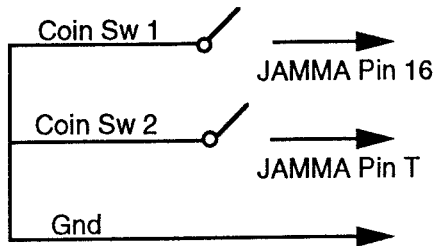

Note: If coin switches are wired separately (as in option 2), then both meter pins 8 & J need to be connected as shown.

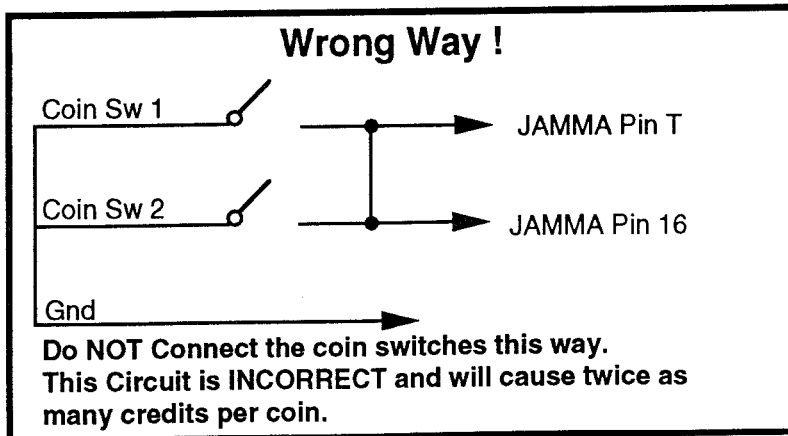

# HIT THE ICE KIT

## Jamma Chart

Function	Wire Color	Pin	Pin	Wire Color	Function
GROUND	BLK	1	A	BLK	GROUND
GROUND	GRN-BRN	2	B	BLK	GROUND
+5 VOLTS DC	GRY	3	C	GRY	+5 VOLTS DC
+5 VOLTS DC	GRY	4	D	GRY	+5 VOLTS DC
- 5 VOLTS DC	GRY-GRN	5	E	GRY-GRN	- 5 VOLTS DC
+12 VOLTS DC	GRY-YEL	6	F	GRY-YEL	+12 VOLTS DC
POST	KEY	7	H	KEY	POST
COIN METER A	WHT-ORG	8	J	WHT-GRN	COIN METER B
	NC	9	K	NC	
SPEAKER (+)	RED-VIO	10	L	GRN-VIO	SPEAKER (-)
	NC	11	M	NC	
VIDEO RED	RED	12	N	GRN	VIDEO GRN
VIDEO BLU	BRN	13	P	WHT	VIDEO SYNC
VIDEO GND	SHIELD	14	R	WHT-RED	SERVICE CREDIT
	GRN	15	S	WHT-VIO	TILT
COIN 1	WHT-BLU	16	T	YEL-WHT	COIN 2
1 START	YEL-GRN	17	U	YEL-BLU	2 START
1 UP MOVE	ORG-BLK	18	V	YEL-BLK	2 UP MOVE
1 DOWN MOVE	ORG-BRN	19	W	YEL-BRN	2 DOWN MOVE
1 LEFT MOVE	ORG-RED	20	X	YEL-RED	2 LEFT MOVE
1 RIGHT MOVE	ORG	21	Y	YEL-ORG	2 RIGHT MOVE
1 PASS/SAVE	ORG-YEL	22	Z	YEL-VIO	2 PASS/SAVE
1 SHOOT/CHECK	ORG-GRN	23	a	YEL-GRY	2 SHOOT/CHECK
NC	ORG-BLU	24	b	VIO-BLK	NC
NC	ORG-VIO	25	c	VIO-BRN	NC
NC	ORG-GRY	26	d	VIO-RED	NC
GROUND	NC	27	e	BLK	GROUND
GROUND	BLK	28	f	BLK	GROUND

# HIT THE ICE KIT CABINET WIRING

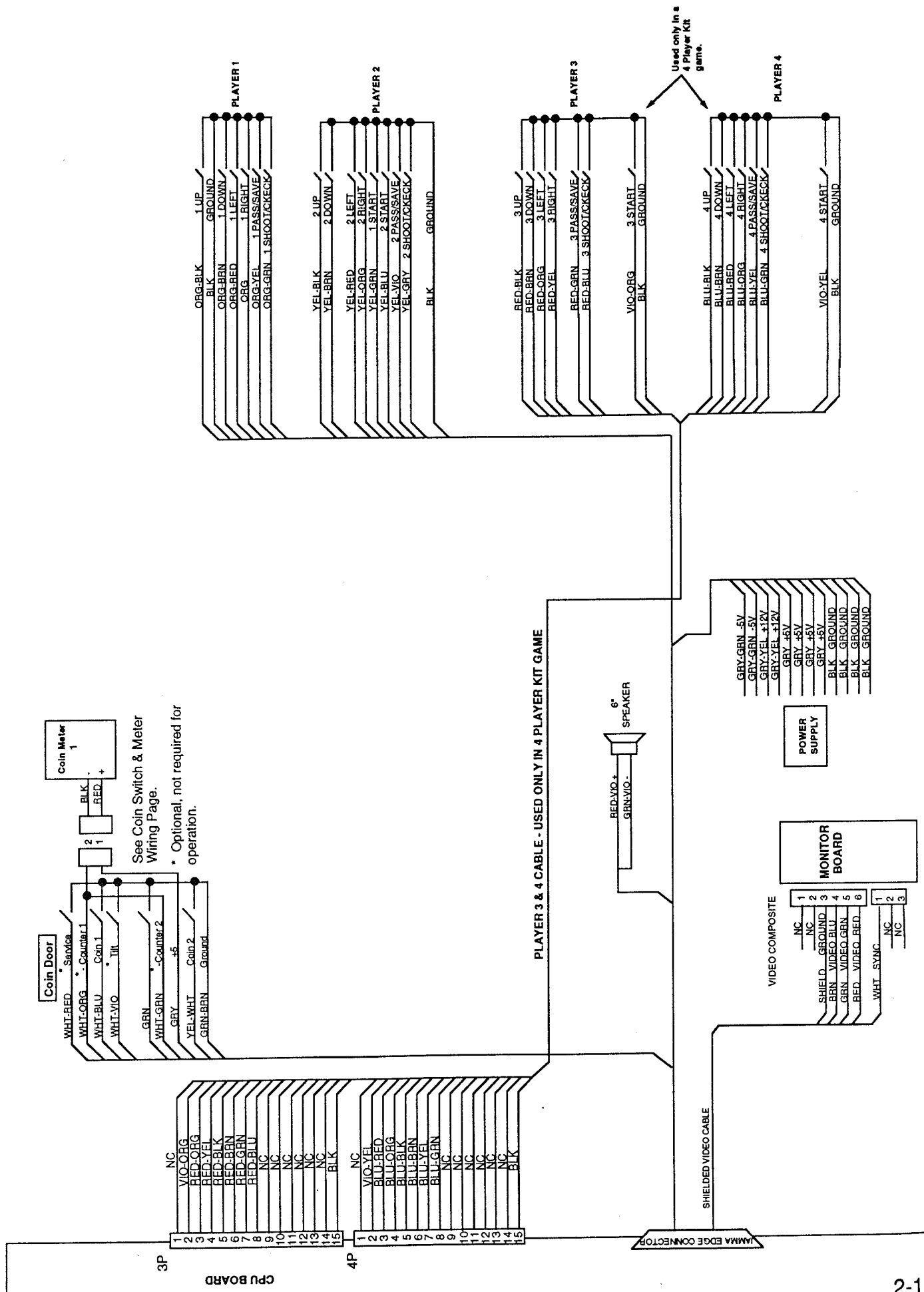

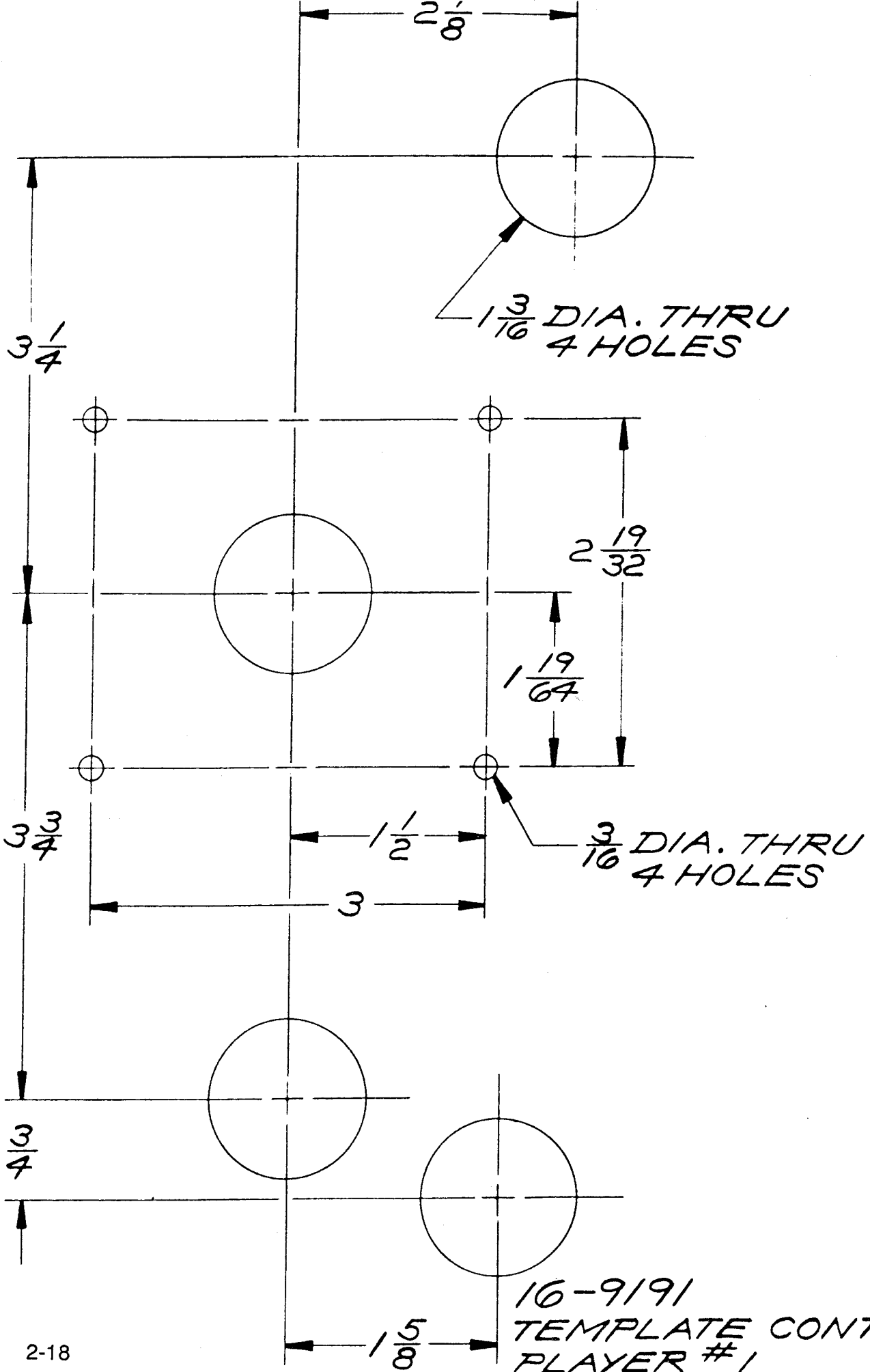

16-9191  
 TEMPLATE CONTROLS  
 PLAYER #1  
 USED ON 30203 KIT

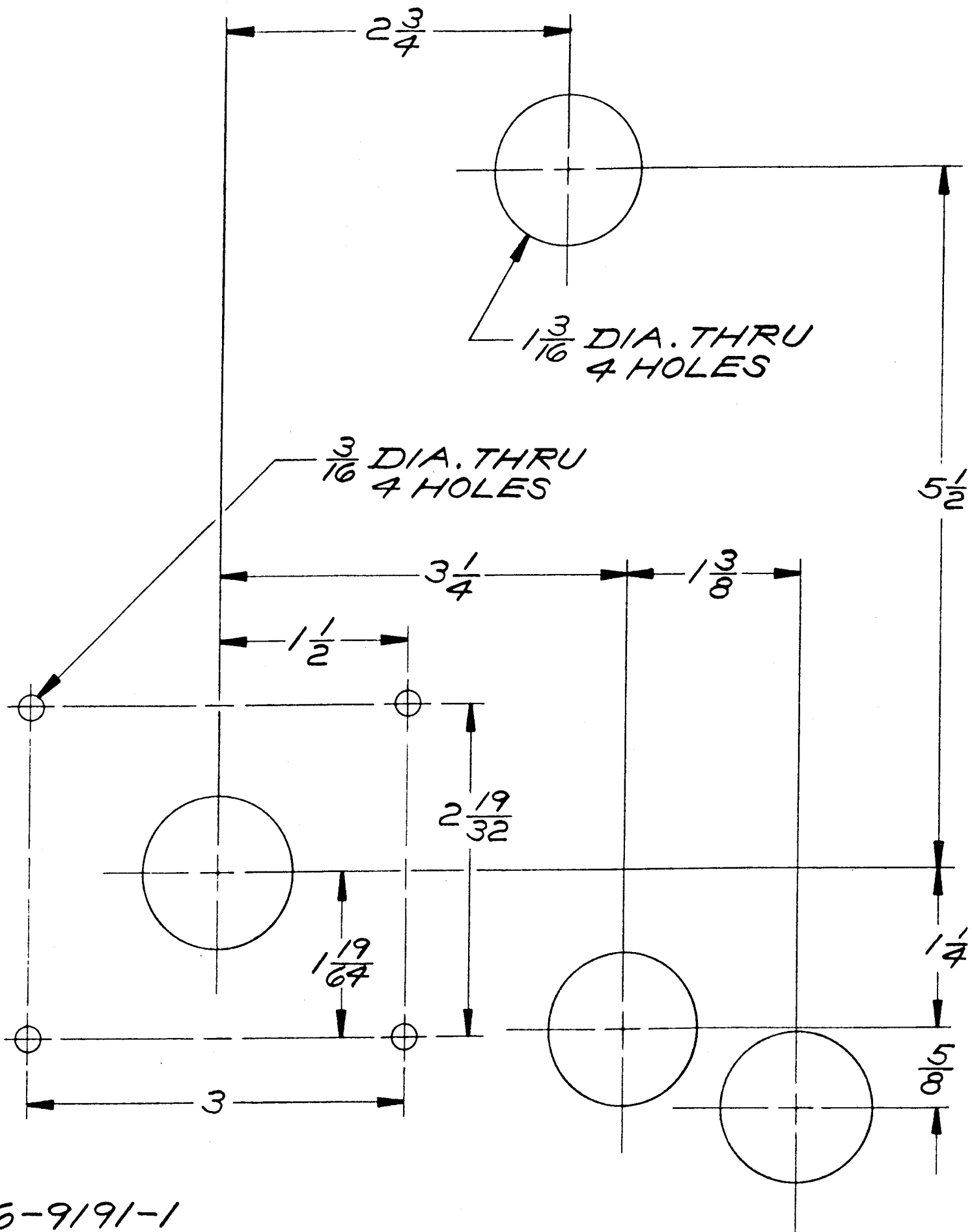

16-9191-1  
 TEMPLATE CONTROLS  
 PLAYER #2  
 USED ON 30203 KIT

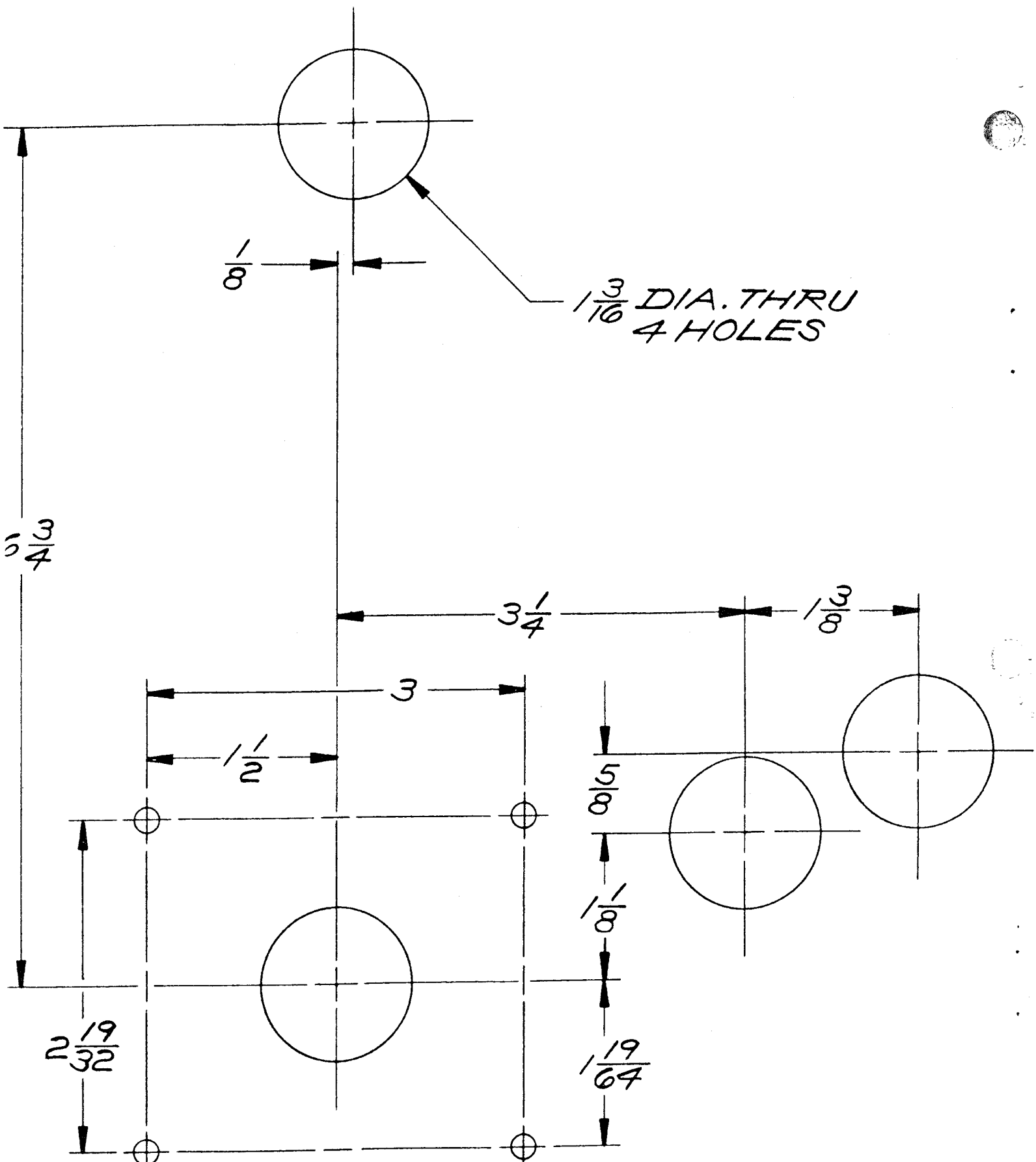

$\frac{3}{16}$  DIA. THRU  
4 HOLES

$\frac{3}{16}$  DIA. THRU  
4 HOLES

16-9191-2  
TEMPLATE CONTROLS  
PLAYER #3  
USED ON 30203 KIT



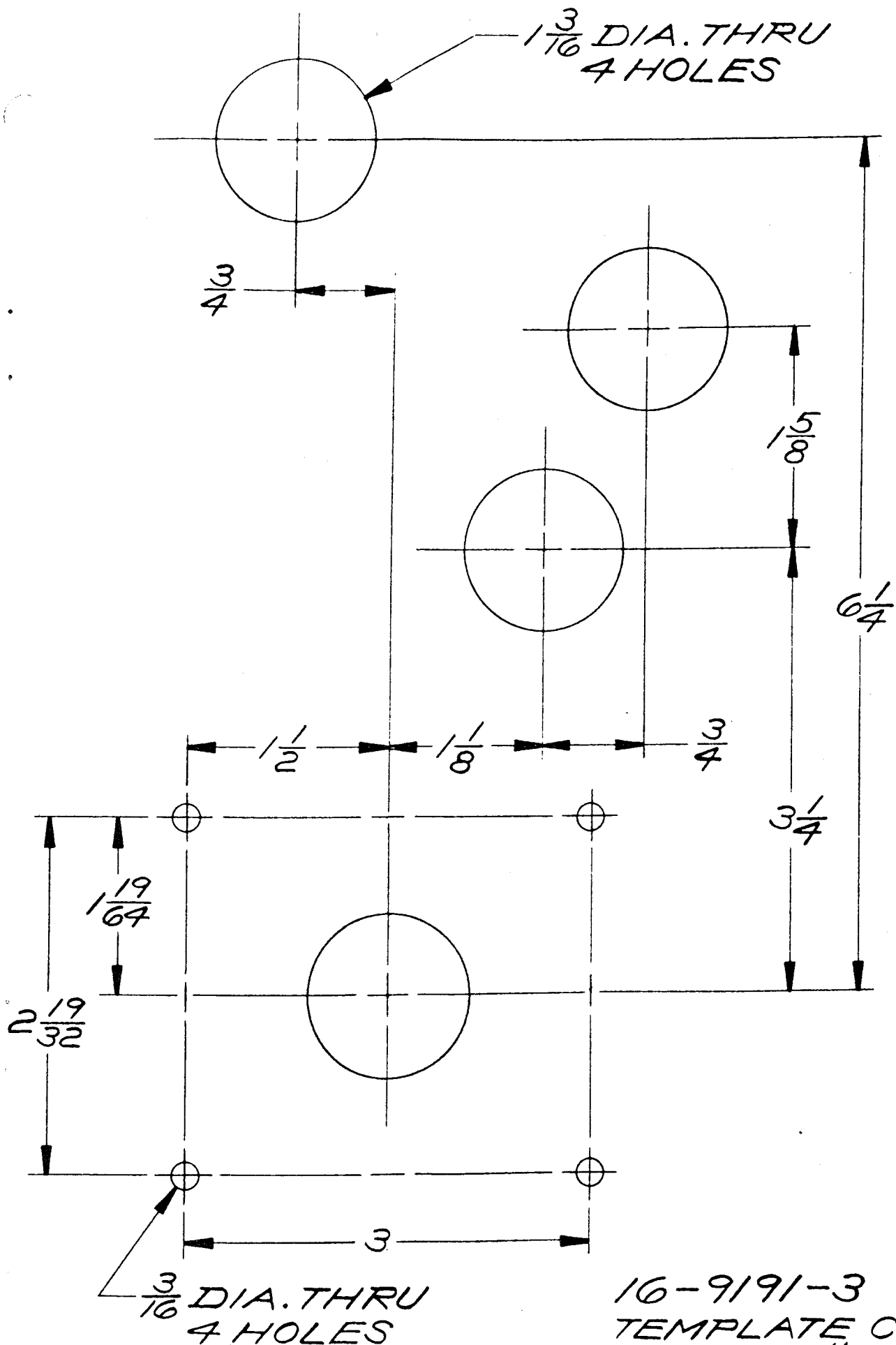

16-9191-3  
 TEMPLATE CONTROLS  
 PLAYER #4  
 USED ON 30203 KIT

# WARNINGS & NOTICES

## Warning

USE OF NON-WILLIAMS PARTS OR CIRCUIT MODIFICATIONS MAY CAUSE SERIOUS INJURY OR EQUIPMENT DAMAGE! USE ONLY WILLIAMS AUTHORIZED PARTS.

\* For safety and reliability, substitute parts and modifications are not recommended.

\* Substitute parts or modifications may void FCC type acceptance.

\* This game is protected by federal copyright, trademark and patent laws. Unauthorized modifications may be illegal under Federal law. This also applies to WILLIAMS logos, designs, publications and assemblies. Moreover, facsimiles of WILLIAMS equipment (or any feature thereof) may be illegal under federal law, regardless of whether or not such facsimiles are manufactured with WILLIAMS components.

## Warning

This equipment generates, uses and can emit radio frequency energy and, if not installed properly and used according to the directions in this manual, may cause interference to radio communications. It has been tested and found to comply with the limits for a Class A computing device pursuant to Subpart J of part 15 of FCC rules which are designed to provide reasonable protection against such interference when operated in a commercial environment. Operation of this equipment in a residential area is likely to cause interference to radio communications, in which the user, at his or her own expense, will be required to take whatever measures may be needed to correct the interference.

## Warning

Prevent shock hazard and assure proper game operation. Only plug this game into a properly grounded outlet. Do not use a cheater plug to defeat the power cord's grounding pin. Do not cut off the ground pin.

## Notice

When Williams Electronics ships a game, it is in compliance with FCC regulations. Your sticker is proof. If the sticker is missing or damaged, legal repercussions to the owner or distributor of the game may result. If your game kit does not contain an FCC sticker, call Williams Electronics immediately.

## Notice

No part of this publication may be reproduced by any mechanical, photographic, or electronic process, or in the form of a phonographic recording, nor may be transmitted, or otherwise copied for public or private use, without permission from the publisher.

Entire contents of this manual copyright © 1990 WILLIAMS ELECTRONICS GAMES, INC. All Rights Reserved.

Programmed By TAITO CORPORATION.

WILLIAMS ELECTRONICS GAMES, INC.  
3401 N. CALIFORNIA AVE.  
CHICAGO, IL 60618

**FOR SERVICE:  
CALL YOUR AUTHORIZED WILLIAMS DISTRIBUTOR.**

ADJUSTMENTS OF GAME PC BOARD (HIT THE ICE G25 00627A)

3P-CONNECTOR		4P-CONNECTOR	
1		1	
2	3P START	2	4P START
3	3P LEFT	3	4P LEFT
4	3P RIGHT	4	4P RIGHT
5	3P UP	5	4P UP
6	3P DOWN	6	4P DOWN
7	3P A-BUTTON	7	4P A-BUTTON
8	3P B-BUTTON	8	4P B-BUTTON
9		9	
10		10	
11		11	
12		12	
13		13	
14	GND	14	GND
15	GND	15	GND

SOLDER SIDE		COMPONENTS SIDE	
GND	A	1	GND
GND	B	2	GND
+5V	C	3	+5V
+5V	D	4	+5V
-5V	E	5	-5V
+12V	F	6	+12V
POST	H	7	POST
(COIN METER B)	J	8	COIN METER A
(COIN LOCKOUT B)	K	9	COIN LOCKOUT A
SPEAKER (-)	L	10	SPEAKER (+)
SOUND GND	M	11	SOUND
VIDEO G	N	12	VIDEO R
VIDEO SYNC	P	13	VIDEO B
SERVICE SW	R	14	VIDEO GND
TILT SW	S	15	
(COIN B)	T	16	COIN A
2P SELECT	U	17	1P SELECT
2P UP	V	18	1P UP
2P DOWN	W	19	1P DOWN
2P LEFT	X	20	1P LEFT
2P RIGHT	Y	21	1P RIGHT
2P A-BUTTON	Z	22	1P A-BUTTON
2P B-BUTTON	a	23	1P B-BUTTON
	b	24	
	c	25	
	d	26	
GND	e	27	GND
GND	f	28	GND

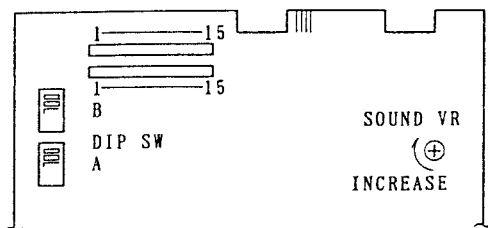

☆ CONTROL OF THIS GAME USES ONE 8-WAY JOYSTICK AND 2 BUTTONS.

NOTE) BEFORE CHANGING THE SETTING OF THE DIP SWITCH, TURN THE POWER OFF.

◇ SETTING OF DIP SWITCH A

(\*): FACTORY SETTING

SETTINGS	POSITIONS	1	2	3	4	5	6	7	8							
GAME STYLE	* MAX. 4P PLAY	OFF	OFF						OFF							
	MAX. 2P PLAY	ON														
TEST MODE	* NORMAL GAME									OFF	OFF	ON	OFF	OFF	OFF	
	TEST MODE									ON						
ATTRACT SOUND	* WITH											OFF	OFF	ON	ON	
	WITHOUT											ON				
PLAY PRICING COIN A (B)	* 1 COIN 1 PLAY									OFF			OFF	OFF	OFF	OFF
	2 COINS 1 PLAY												ON			
	3 COINS 1 PLAY		OFF	ON												
	1 COIN 2 PLAYS		ON		OFF											
	1 COIN 3 PLAYS		OFF	ON												
	1 COIN 4 PLAYS		ON		OFF											
	1 COIN 5 PLAYS		OFF	ON												
1 COIN 6 PLAYS	ON	ON														

◇ SETTING OF DIP SWITCH B

SETTINGS	POSITIONS	1	2	3	4	5	6	7	8
GAME DIFFICULTY EASY(A) → DIFFICULT(D)	* RANK B	OFF	OFF						
	RANK A	ON							
	RANK C	OFF	ON						
	RANK D	ON							
TIMER COUNT	* 1 SEC.=58/60S			OFF	OFF	OFF			
	1 SEC.=56/60S			ON					
	1 SEC.=52/60S			OFF	ON				
	1 SEC.=48/60S			ON					
MAX. CREDIT	* 9								OFF
	99								ON