

A-10

TANK KILLER™

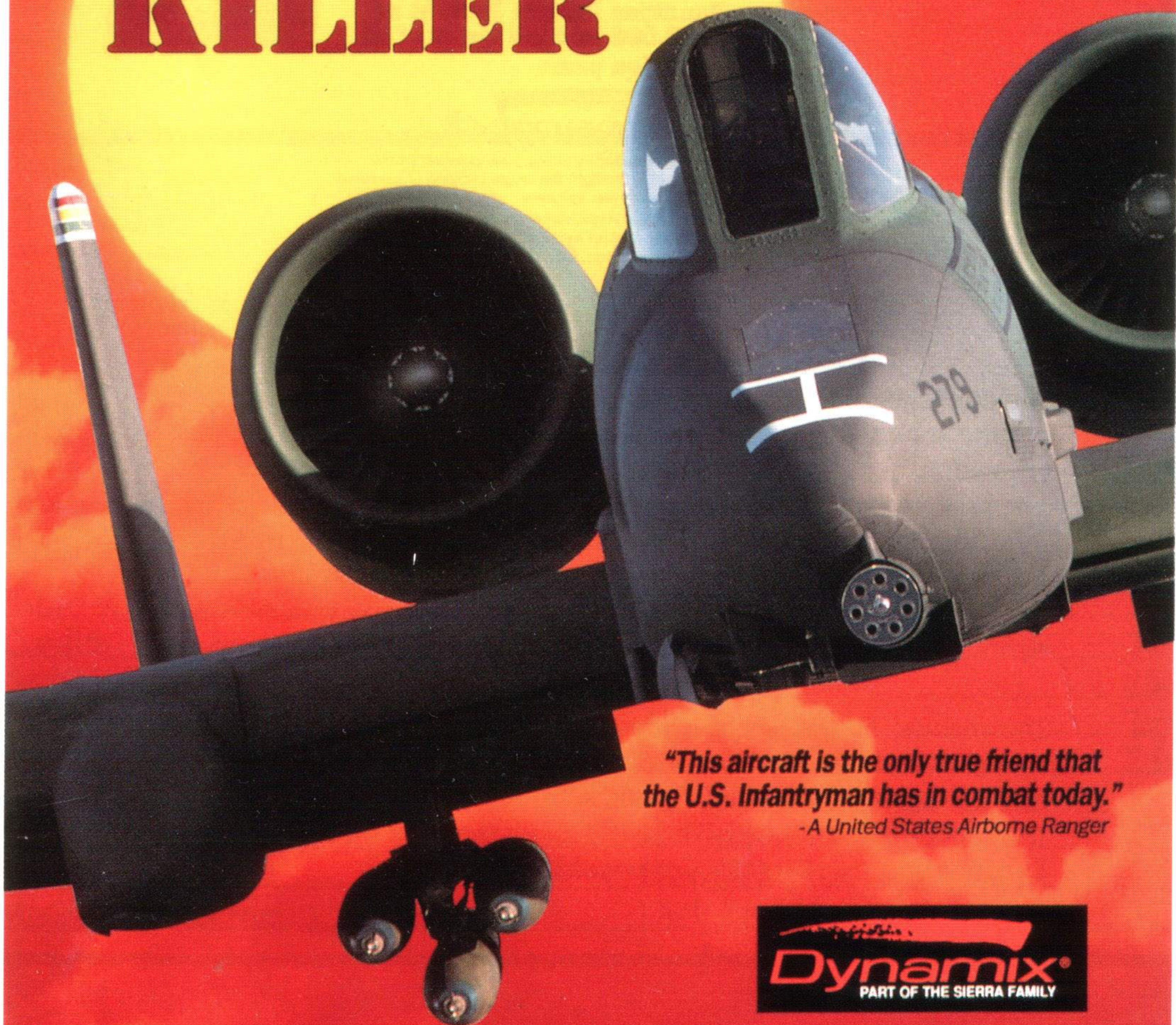

*"This aircraft is the only true friend that
the U.S. Infantryman has in combat today."*

-A United States Airborne Ranger

Dynamix®
PART OF THE SIERRA FAMILY

IT IS ILLEGAL TO MAKE UNAUTHORIZED COPIES OF THIS SOFTWARE

This software is protected under federal copyright law. It is illegal to make or distribute copies of this software except to make a backup copy for archival purposes only. Duplication of this software for any other reason including for sale, loan, rental or gift is a federal crime. Penalties include fines of as much as \$50,000 and jail terms of up to five years.



as a member of the Software Publishers Association (SPA), supports the industry's effort to fight the illegal copying of personal computer software.

Report copyright violations to:
SPA, 1101 Connecticut Avenue, NW, Suite 901
Washington, DC 20036

LIMITED WARRANTY NOTICE

The publisher of this software wants your continued business. If you fill out the enclosed product registration card and return it to us, you are covered by our warranty. If your software should fail within 90 days of purchase, return it to your dealer or directly to us, and we will replace it free. After 90 days, enclose \$5 for 5.25" disks (or \$10 for 3.5" disks) and return the software directly to us. Sorry, without the registration card you are not covered by the warranty. This warranty gives you specific legal rights, and you may also have other rights which vary from state to state.

COPYRIGHT NOTICE

This manual, and the software described in this manual, are copyrighted. All rights are reserved. No part of this manual or the described software may be copied, reproduced, translated or reduced to any electronic medium or machine-readable form without the prior written consent of Dynamix, Inc. P.O. Box 485, Coarsegold, CA 93614.



P R E S E N T S

A-10 TANK KILLER

Contents

Table of Contents	1	Briefing/Debriefing	16
Credits	2-3	Mission Summary	17
Technical	4-6	Weapons Load	18
Trouble Shooting	7	The Simulation	19
Controls	8-9	Simulation Systems	24
Game Overview	10	A-10 Pilot's Manual	29
Menu Controls	12	A-10 Pilot Interview	41
Main Select Menu	13	Design Notes	43
Mission Select Menu	15	Disk Problems	44

Credits

A-10 Tank Killer

Designer	Damon Slye
Programming	Lincoln Hutton
With	David McClurg
Amiga Programming	Joseph Wingard
Art Director	Kobi Miller
Amiga Artwork	Mark Brenneman
3D Art and Animation	Mark Brenneman Cyrus Kanga
Dir. of Image Production	Randy Dersham
Casting/Costuming	Sher Alltucker
Mission Design	David Selle Damon Slye Mick Westick
Sound Effects and Musical Editing ..	Bryce Morsello
Amiga Sounds and Music	Mark Riley
Musical Score	Alan McKean
Design	Damon Slye Jerry Luttrell
Executive Producer	Jeff Tunnell

Technical Support

EGA and VGA graphics	Peter Lukaszuk
3Space™	David McClurg
Smart Start™	Richard Rayl David McClurg Peter Lukaszuk
Amiga Technical Support	Nels Bruckner David McClurg
Quality Assurance	Lloyd Madden Forrest Walker Kurt Windisch Mick Westrick Dan Hinds

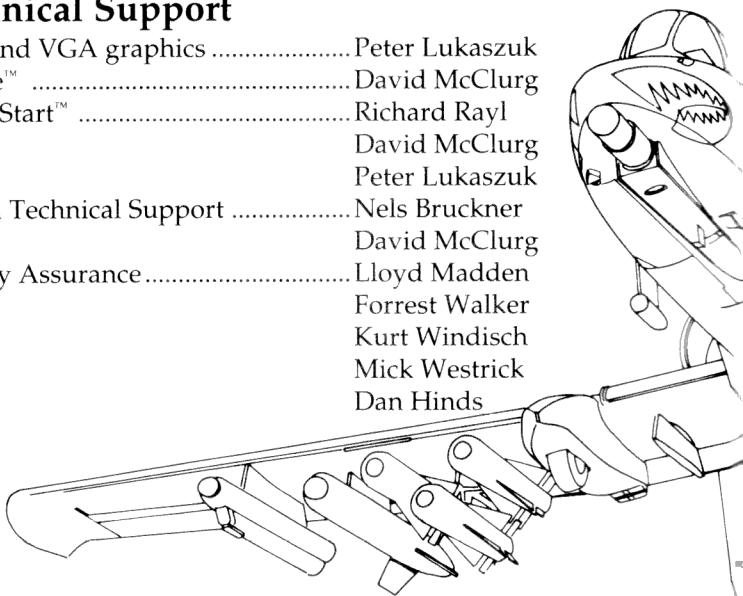

Credits

Cast

Rich Scheeland	as	Commander Cord
Dave Shew	as	Captain Buck Ryan
Brian Hahn	as	Lieutenant Jake Styles

Additional Support

Package Illustration.....	Roger Smith
Documentation.....	Jerry Luttrell
	David Selle

Special Thanks

Maj. Chuck "Hollywood" Temple, USMCR
Oregon Air National Guard
Flightcraft
23rd Tactical Fighter Wing
Greg Dean

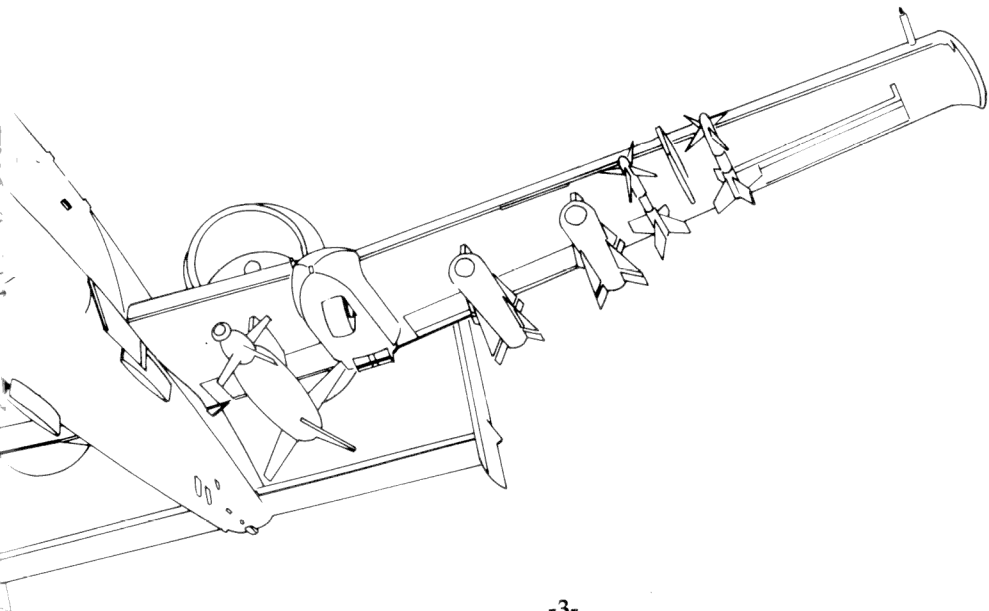

Technical (MS-DOS)

MS-DOS Installation Procedure for A-10 Tank Killer

Smart Start™

In an effort to make game installation as painless as possible, we've created Smart Start™. Smart Start™ will automatically determine the graphics, sound, input devices and the speed capability of your computer system to optimize game characteristics. Smart Start™ will also take you step-by-step through the process of installing your game on a hard drive or making a backup copy. Don't be intimidated, just jump in and try it!

In the example below it is assumed that you are using floppy drive A, if not please substitute all references to drive A with the appropriate drive label.

Copying A-10 Tank Killer to a Hard Drive

1. After booting, insert A-10 Tank Killer disk 1 in Drive A
2. Type **A:**
3. Type **INSTALL**
4. Select "**Copy A-10 to Hard Drive**" from the Smart Start™ menu.
5. Follow the on screen instructions.

Making a Backup Copy

A-10 Tank Killer is not copy protected and it is recommended that you do not play from the original disks. Smart Start™ has a built in facility for helping you to create a backup.

1. After booting, insert A-10 Tank Killer disk #1 in Drive A:
2. Type **A:**
3. Type **INSTALL**
4. Select "**Create backup copy of A-10**" from the Smart Start™ menu.
5. Follow the on screen instructions.

Setting Preferences

Smart Start™ will do its best in deciding what type of computer equipment you have, but sometimes it may make a mistake or you may wish to try other graphics modes, sound configurations, etc. To modify Smart Start™ preferences, follow these steps:

1. **From a floppy disk:** insert A-10 Tank Killer disk #1 and type: **A:**
From a hard drive: go to the A-10 directory on your hard drive.
3. Type **INSTALL**
4. Select "**Change Graphics**" or "**Change Sounds/Music**" from the Smart Start™ menu.
5. Follow the on screen instructions.

To run the game type "A10" from the A-10 Tank Killer hard disk directory or floppy disk #1.

Technical(AMIGA)

Amiga Installation Procedure for A-10 Tank Killer

Following are instructions for installing the program onto a hard disk and booting the program. Both can be done from either the Workbench icons or the CLI. In the instructions we are assuming that you are using floppy drive DF0: and hard disk DH0:. If yours are different, replace the drive label in the example with the correct one.

Copying A-10 Tank Killer to a Hard Drive

1. Boot your system.
2. Insert A-10 Disk #1 into a floppy disk drive.
3. From Workbench, double click on the A10 #1 icon and then on the Install icon.
4. From the CLI, type **CD DF0:** and press **ENTER**
5. Type **INSTALL** and press **ENTER**
The Dynamix Install Utility window will come up.
6. Choose which drive and directory you wish to install the program to. The default is: DH0:DYNAMIX/A10. To change the path, click on the Destination Directory default path and type in the new one.
5. Then click on the INSTALL button.
6. At the prompt window, to install the program files click on the OKAY button. To cancel the installation process, click on the CANCEL button.

Note: If you are using a backup copy of the program that was created with the AmigaDOS Duplicate feature, you must rename the copies of both game disks to remove the words "copy of" from the disk label. If the words "copy of" are not removed, you will be unable to use the Hard Disk Installation feature.

Technical(AMIGA)

Amiga Loading Instructions

From Floppy Diskettes

Note: You may run the A-10 program from two floppy drives.

Self Booting

1. Insert A-10 Disk #1 into drive DF0:
2. Turn on the system

From Workbench

1. Boot your system with Workbench
2. Insert A-10 Disk #1 into a disk drive
3. Double click on the A10 #1 icon
4. Double click on the A10 icon

From the CLI

1. Boot your system with the CLI
2. Insert A-10 Disk #1 into floppy drive DF0:
3. Type **CD DF0:** and press
4. Type **A10** and press

From a Hard Disk

From Workbench

1. Load Workbench
2. Double click on the hard disk icon
3. Double click on the Dynamix drawer
4. Double click on the A10 drawer
5. Double click on the A10 icon

From the CLI

1. Load a CLI window
2. Type **CD DH0:/DYNAMIX/A10** and press
3. Type **A10** and press

Trouble Shooting

Problem: My computer has at least 512K of memory, but I receive a message saying there is not enough memory to run A-10 Tank Killer.

Possible Solution: Your computer may be running a “pop up” (TSR) program or it may be connected to a device such as a LAN that uses a portion of the memory. In order to run A-10 Tank Killer, you will need to free up some of the computer’s memory or select a different graphics mode from the Smart Start™ (Install) program.

Problem: The joystick is not working properly.

Possible Solution: Press **ALT-C** to calibrate the joystick.

Problem: When playing from the keyboard strange things happen such as the cursor moving all around the screen.

Possible Solution: Press **ALT-J** to turn off the joystick or **CTRL-M** to disengage the mouse. Also, joystick calibration, **ALT-C**, may alleviate the problem.

Problem: Constantly playing music bugs me, but I still want to hear sound effects.

Possible Solution: Press **ALT-M** to turn off the music.

Problem: Graphics appear in a mode that I don’t want.

Possible Solution: Type **INSTALL** then use Smart Start™ to select the type of graphics you desire.

Problem: When I run the program I get multiple small images or complete garbage on the screen.

Possible Solution: You are probably using a VGA card which is not 100% register compatible. Select MCGA as the graphics option from Smart Start™.

Amiga Specific Notes:

1. A-10 cannot be multi-tasked with other programs. Make sure no other programs are being executed in the background while running A-10.
2. If you have a problem running the program, check to see that the stack is not set to an incredibly high or low amount. The default value of 4000 should work fine.

If you have a problem that is not addressed on this list, please call or write our Customer Support Line at:

Dynamix/Sierra Customer Support
P.O. Box 485, Coarsegold, CA 93614
(209) 683-8989.
8 A.M. TO 5 P.M. (PT) Monday through Friday

CONTROLS

FLIGHT CONTROL

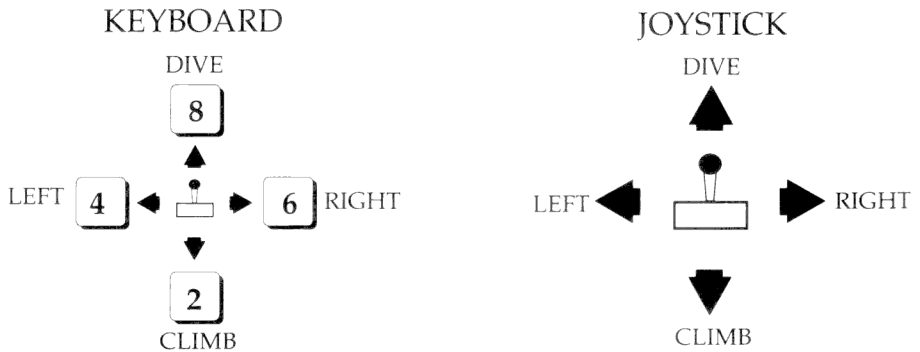

FIRE BUTTONS

KEYBOARD

JOYSTICK

Avenger Cannon = **SPACE BAR**

Button #1 = Avenger Cannon

Selected Weapon = **ENTER**

Button #2 (MS-DOS) = Selected Weapon

A-10 Views

Cockpit Views (Function Keys)

F1 Look Forward
F2 Look Left
F3 Look Right

Outside Views (Function Keys)

F4 Front View
F5 Left Side View
F6 Right Side View
F7 Rear View
F8 Victim View
F9 Engagement View
F10 Reverse Angle Engagement View

CONTROLS

ACTIVE KEYBOARD KEYS

KEY	SIMULATION	MENU SCREENS
SPACE BAR	Fire Avenger 30mm cannon	Depress hot pad
	Fire Selected weapon	Choose current menu selection
TAB	Toggles next target for HUD and TID	Next menu selection
ESC	Brings up Control Menu, pauses game	Skips Briefing
P	Pause Game	
M	Displays Strategic Map	
S	Brings up Status Screen.	
D	Display Message log	
Q	Brings up Quit Menu	
+	Select next active weapon	
-	Select previous active weapon	
H	Select Maverick	
J	Select LGB	
K	Select Rockeye	
L	Select Durandal	
;	Select Sidewinder	
<	Left Rudder	
>	Right Rudder	
Numeric 1-9	Throttle: 1 = no throttle, 9= full throttle.	
F	Release Flare	
C	Release Chaff.	
R	IN MAP SCREEN: On/Off switch for SAM range on Strategic Map	

Game Overview

Welcome to A-10 Tank Killer. To make learning the game as quick and easy as possible, the following overview is offered. It is a quick guide to the menuing system and game play. An in depth description follows this introduction which provides a detailed description of each screen.

Main Select Menu

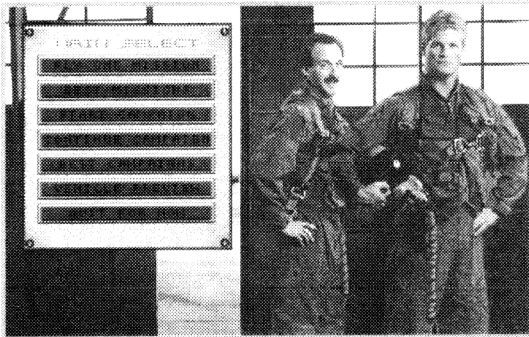

Quit For Now



Fly One Mission

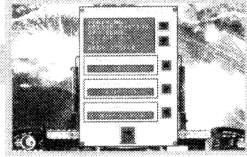

Start Campaign



Continue Campaign



Best Campaigns

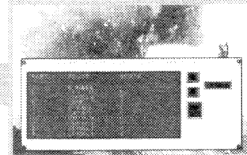

Best Missions

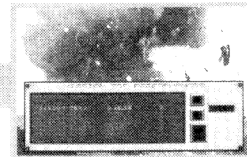

Vehicle Preview



Briefing

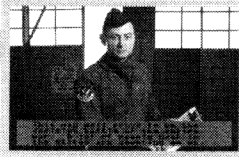

Weapons Load

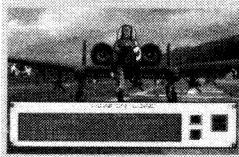

Status Screen

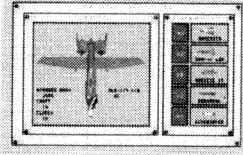

VCR Interface™

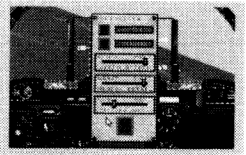

Simulation

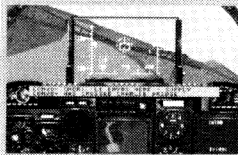

Strategic Map

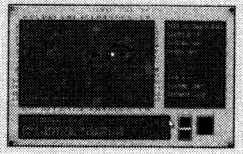

Multiple Views

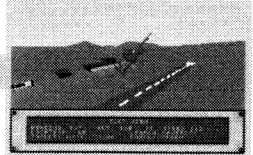

Quitting



Debriefing



Mission Summary

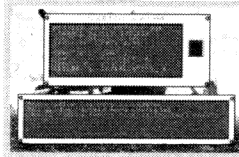

Menu Controls

The menuing system for A-10 Tank Killer was designed to be intuitive and easy-to-use for both novice and advanced users. Following are a few simple tips and instructions that explain basic menu use.

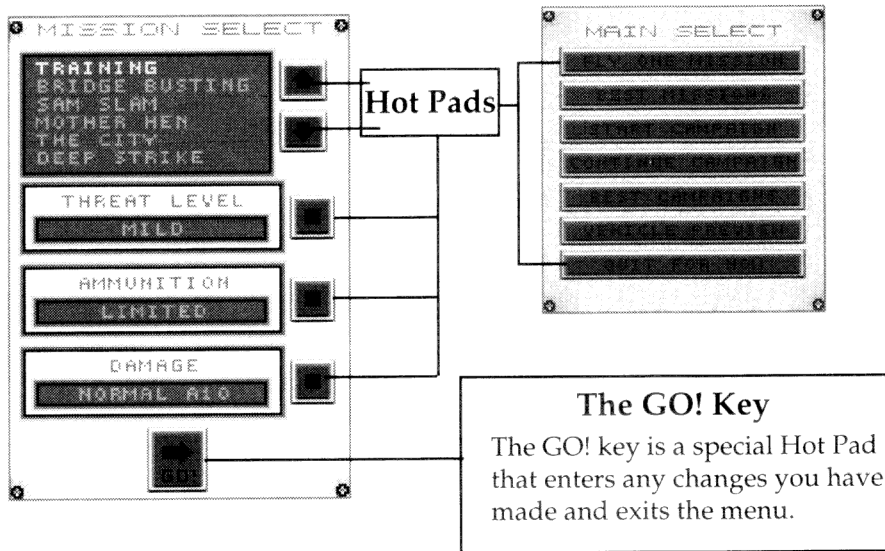

Mouse, Joystick or Keyboard Control

The on screen arrow can be moved by mouse, joystick or keyboard.

Mouse

Select **Hot Pad**: Move mouse to position arrow on **Hot Pad** and press either mouse button to select.

Joystick

Select **Hot Pad**: Move joystick to position arrow on **Hot Pad** and press the joystick button to select.

Keyboard

Select **Hot Pad**: Press the "TAB" key to move the arrow from one **Hot Pad** to another. Press the "Space Bar" to select.

Main Select Menu

The first menu screen is Main Select. It is the starting point from which you enter the game.

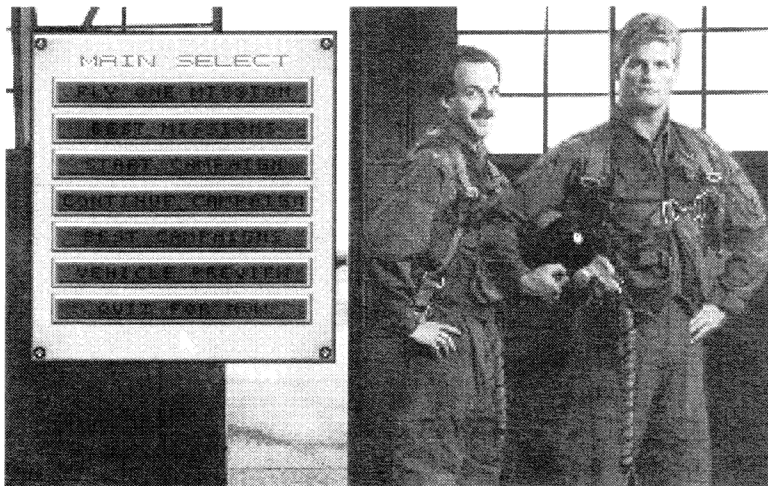

Mission or Campaign?

Among the seven menu choices in **Main Select Menu** are **Fly One Mission** and **Start Campaign**. These are the two modes of game play that A-10 Tank Killer offers.

Fly One Mission allows you to individually select which mission to fly. Each mission will include a Briefing/Debriefing, Weapons Select and Mission Summary. When a mission is completed or exited, you will be returned to the **Main Select Menu**.

Start Campaign enters you into a preset "tour of duty." You will start at mission #1 and continue until you have either completed all of the missions, are shot down or lose the war. A key element of Campaign Mode is that goals, objectives and key players are carried over from one mission to the next. In Campaign Mode, if you do poorly in the first mission, it may come back to haunt you. Also important in Campaign Mode is that Campaigns can be saved for later continuation. When beginning a campaign, you will enter a character name. The campaign will be saved under this name and can later be viewed or continued.

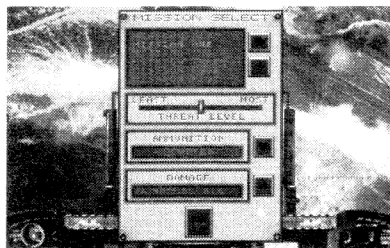

Also available from the Main Select Menu

Gives you the option of continuing a saved campaign.

Continue Campaign

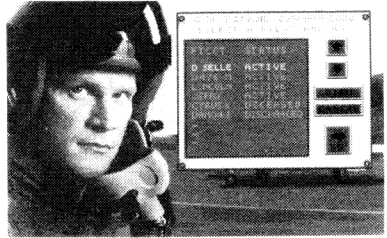

Best Campaign

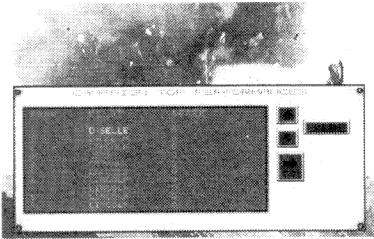

Allows you to view the best performances of all Campaign Mode players.

Best Mission

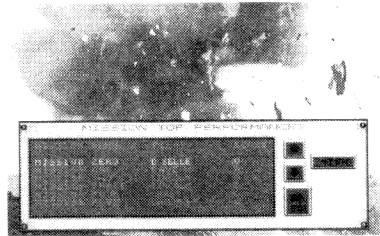

Displays a "Hall of Fame" for best performances on a single mission.

Vehicle Preview

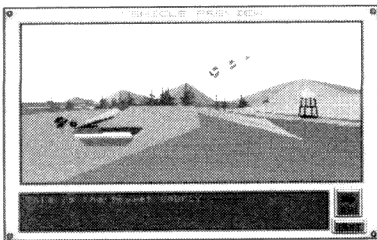

Allows you to preview the weapons and vehicles used by both friendly and enemy forces.

Quit

Quits the game and exits to DOS.

>Welcome To DOS

Mission Select Menu

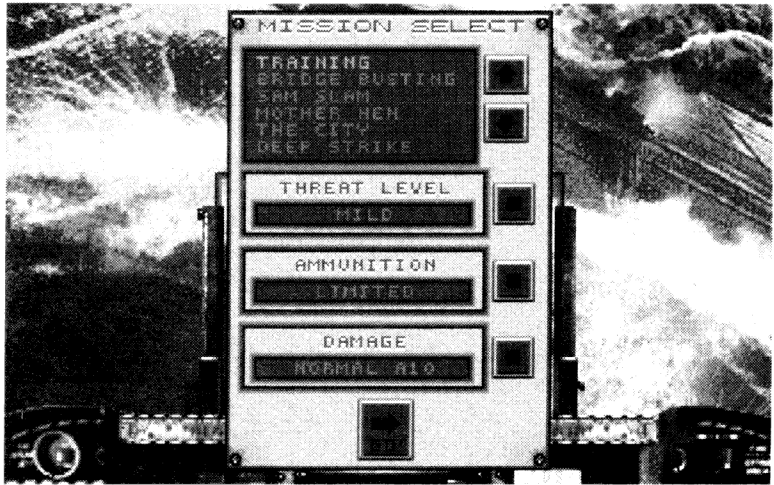

Under the **Mission Select Menu**, you will be able to select a single mission and tailor its difficulty level and game play parameters. These include:

Threat Level

You can individually tailor the degree of difficulty in each mission.

Mild = Wimp Mode

Aggressive = Pretty Mean Suckers

Fierce = Major Bad News

Ammunition

You may select a "limited" or "unlimited" ammunition supply.

Damage

You may select a "normal" or "invincible" A10.

A setting of "normal" means that your A-10 can be damaged.

A setting of "invincible" means that your A-10 can not be damaged.

NOTE:

Scores achieved with selection of either "unlimited" ammunition or "invincible" damage WILL NOT be recorded into the hall of fame.

Briefing/ Debriefing

Meet Commander Cord, your commanding officer. He's full of advice, wisdom and orders. You will meet with him before and after each mission. In the Briefing, he will instruct you as to the current situation and give you your orders. Of course, once airborne, you and your co-pilot are free to do as you wish. BUT, assuming you make it back alive, you'll have to answer to Cord in Debriefing.

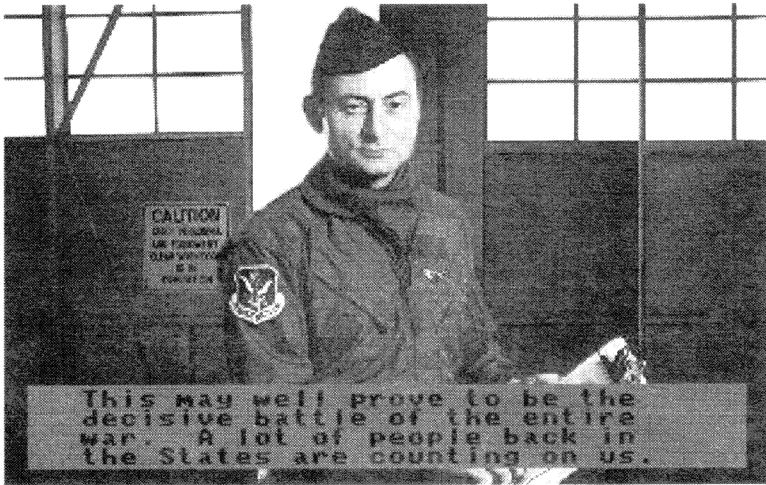

Mission Briefing



Mission Debriefing

Mission Summary

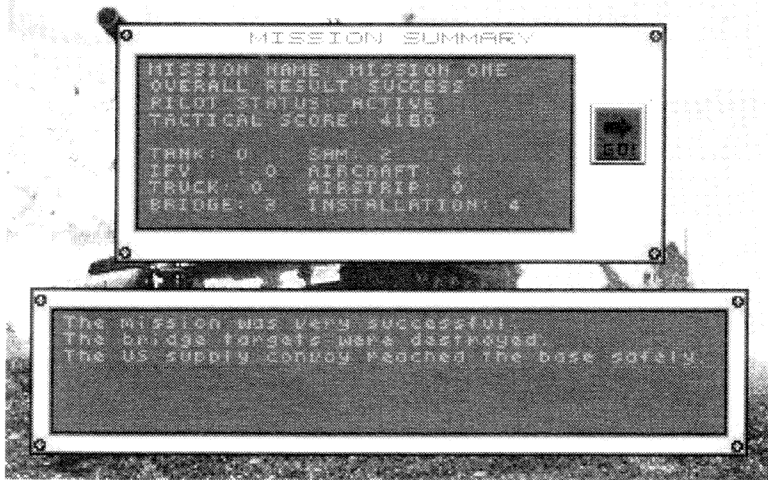

Mission Summary

After each mission Debriefing, you will receive a Mission Summary. Mission summaries contain all data on your latest performance. You will be given the overall result of the mission and your tactical score (a point system based upon number and type of kills).

Campaign Summary

In Campaign Mode, you will receive both a Mission Summary and a Campaign Summary. The Campaign Summary contains a cumulative tactical score (compiled from all missions played). Following the Campaign Summary screen will be the Campaign Decision screen. This will be the point at which you can decide to **Receive Next Assignment** or **Return To Main Select Menu**. Choosing **Receive Next Assignment** will place you into the next mission of the campaign. Choosing **Return To Main Select Menu** will save your place in the current campaign and return you to the **Main Select Menu**. Once saved, a campaign can be restarted at any time from the Continue Campaign section of the **Main Select Menu**.



Campaign Summary



Campaign Decision

Weapons Load

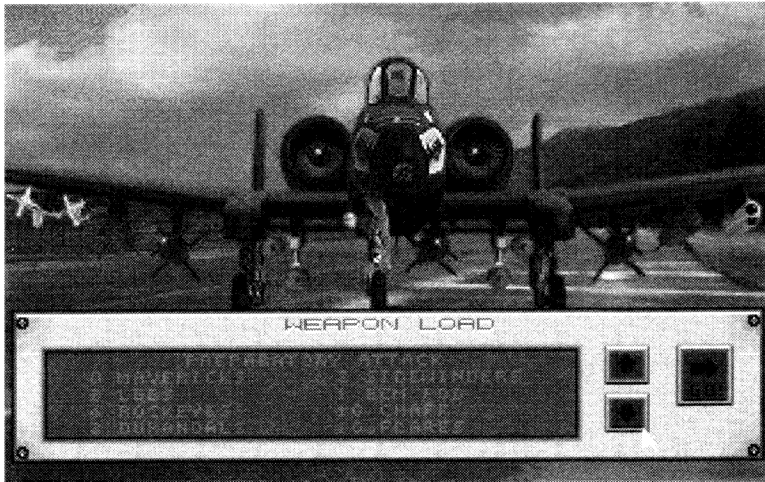

The final screen you will encounter before entering the simulation will be Weapons Load. You will be presented with a choice of 5 preset weapon loads, one of which will be designated as the **Recommended** selection. The recommended load is based upon the specific goals of each mission and will, for the most part, prove most effective. However, as you play each mission and develop your own strategy, you may find that selections other than those recommended are more useful.

(See Weapon Systems: Page 30)

Select the proper weapon type to use against the target.

Against Tanks: Select Avenger 30mm cannon, or select a MAVerick.

Against Other Vehicles: Select Avenger, MAVerick, or ROCKeye cluster bomb (especially if there are several vehicles close together).

Against Bridges, Bunkers, Buildings, or Installations: Select LGB.

Against Airstrips: Select DURandal.

Against Aircraft: Select SIDewinder.

The Simulation

Every care has been taken to make the simulation of the A-10 Thunderbolt II as realistic as possible while not bogging the game down with unnecessarily complicated controls. What you get is a very accurate representation of the *feeling* of A-10 flight without the burden of intricate flight knowledge. Flying the A-10 is as simple as grabbing the joystick and throttling up. And, with the VCR Interface™, you are given complete control over 3-D definition, window size and mission difficulty levels. (See VCR Interface™: Page 27).

Cockpit Instruments

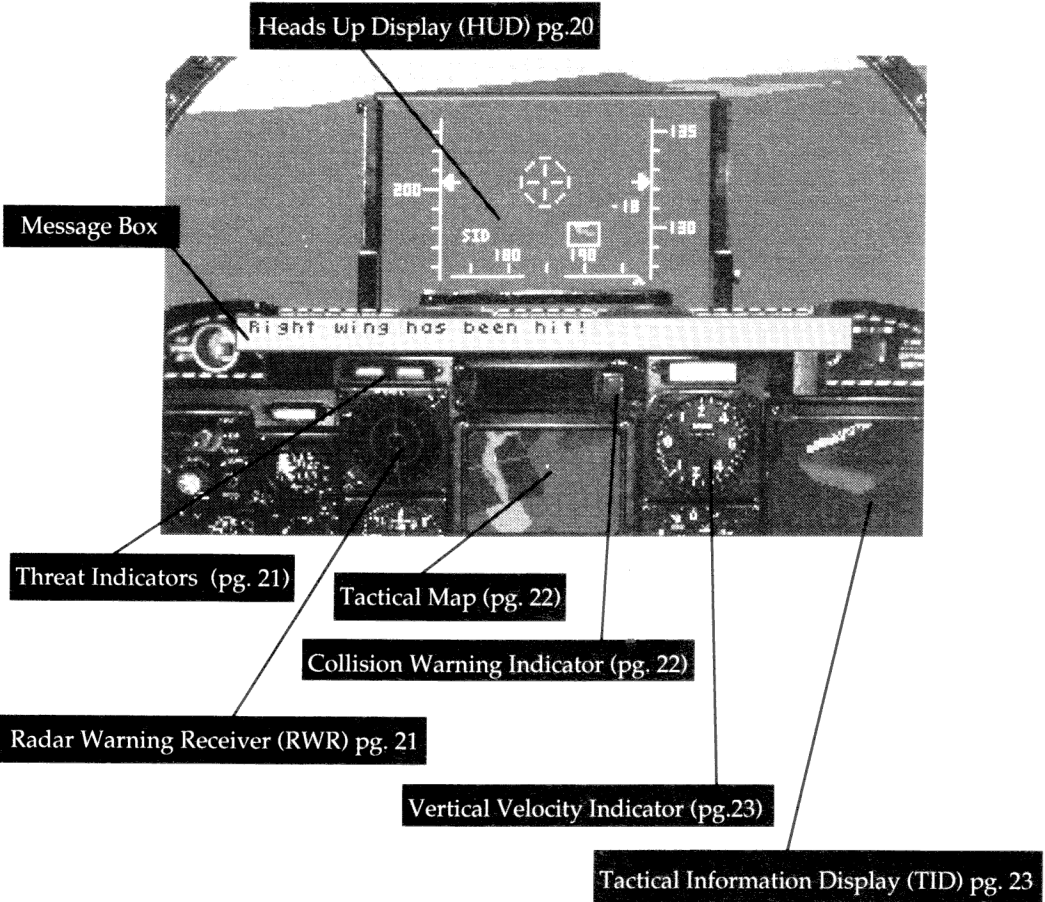

Heads Up Display (HUD)

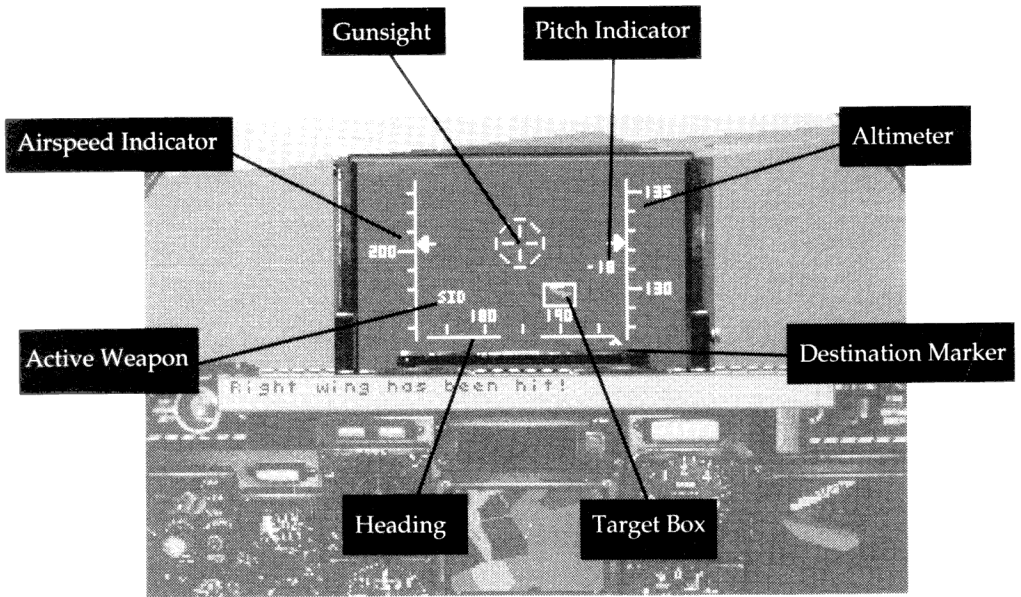

Gunsight: Position target within the cross-hairs to line up the GAU-8 Avenger cannon.

Airspeed Indicator: Displays airspeed in knots.

Active Weapon: The active weapon display on the HUD indicates the currently selected weapon: (For Information on Active Weapons See: **Weapon Systems: pg. 30**)

- MAV = AGM-65 Maverick
- LGB = Paveway LGB
- ROC = Rockeye II CBU
- DUR = Durandal
- SID = AIM 9L Sidewinder

NOTE: FOR HEADING
NORTH is at 0° **EAST** is at 90°
SOUTH is at 180° **WEST** is at 270°

Heading: Shows the A-10s current heading in degrees.

Target Box: Indicates current target for the Tactical Information Display (TID).

Destination Marker: Indicated direction to current destination. To find your way to the currently selected target on the Strategic Map, center the Destination Marker in the HUD and keep it there. (See **Strategic Map: pg. 24**)

Altimeter: Displays current altitude in feet.

Pitch Indicator: Indicates the A-10s pitch in degrees.

Threat Indicators

This pair of LEDs mounted above the Radar Warning Receiver (RWR) warns the A-10 pilot when an infra-red (IR) or radar guided SAM has locked onto his aircraft. The left LED indicates an IR Missile has locked onto the A-10. The right LED indicates a radar missile threat. (See **Defensive Weapons Systems: pg. 35**)

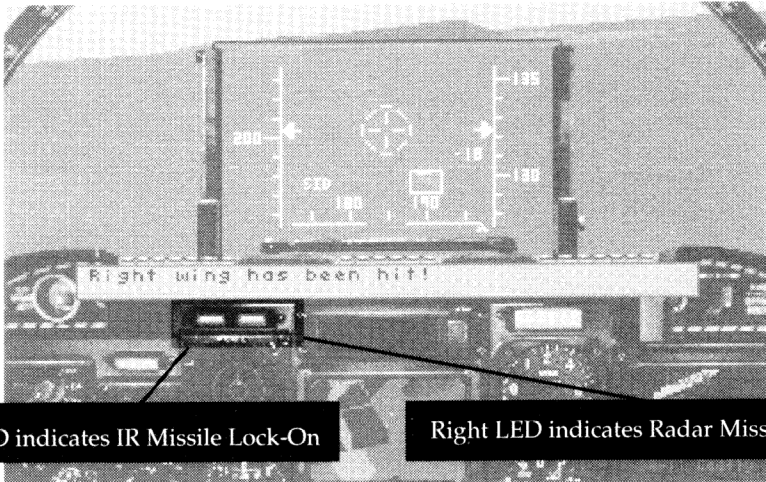

Radar Warning Receiver (RWR):

The RWR senses Surface-to-Air missiles (SAM) and aircraft and displays a dot representing each of these threats on the RWR console. A red dot indicates a SAM threat, a blue dot represents an air threat, and a white dot indicates an incoming missile. These dots blink when you have successfully jammed a target with the Automatic Jamming equipment that is standard on your A-10 Thunderbolt II. (See **Defensive Weapons Systems: pg. 35**)

Red dot = SAM Launcher

Blue Dot = Air Threat

White Dot = Incoming Missile

Jammed Targets = Blinking Dot

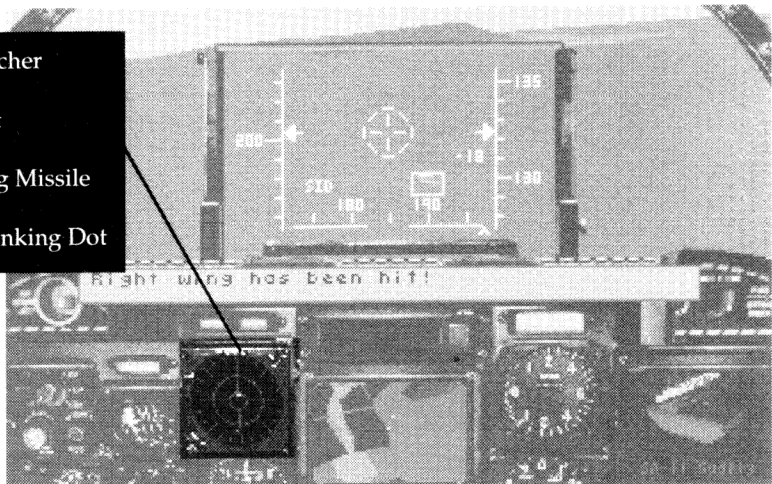

Tactical Map

The tactical map displays all terrain in a 40km X 30 km area around the A-10. The A-10s current grid position is displayed at the bottom center of the tactical map.

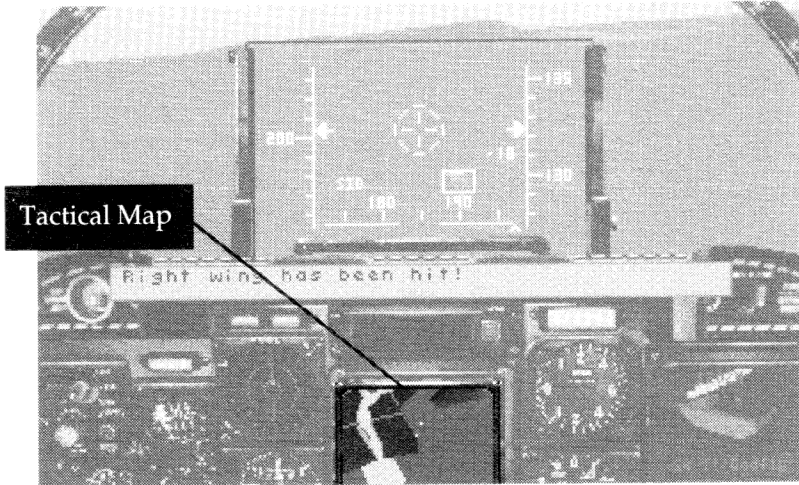

Collision Warning Indicator

This LED warns the pilot of an imminent crash with the ground.

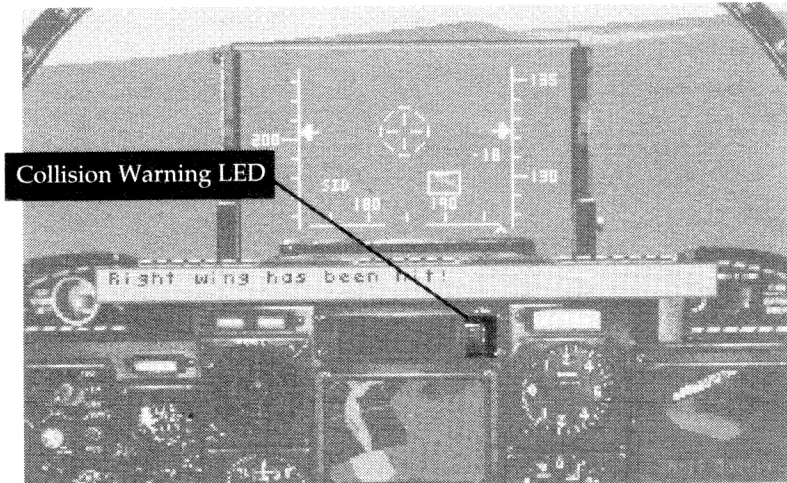

Vertical Velocity Indicator

The Vertical Velocity Indicator gauge displays how quickly the A-10 is gaining or losing altitude. It points directly to the left in level flight.

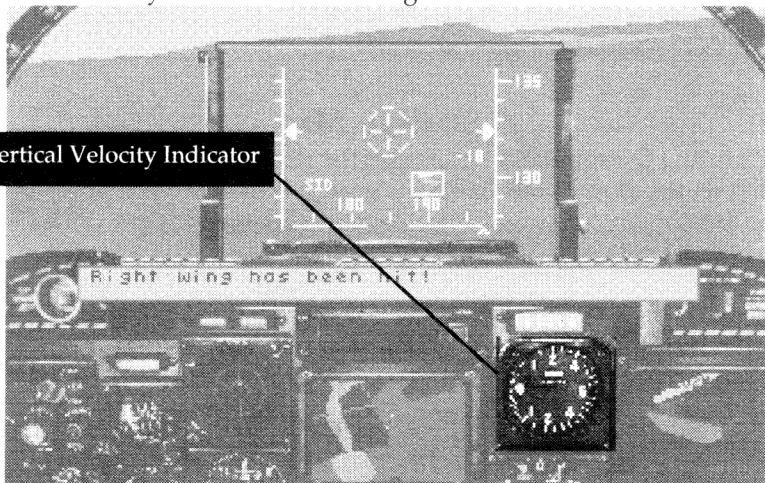

Tactical Information Display (TID)

The TID displays the current target that the Weapons System is locked onto. If a weapon is fired, it will engage the displayed target. The TID provides target range, target identification and IFF (Identify Friendly or Foe) information with hostile targets displayed in Red text and friendly targets displayed in White text. (See **Vehicle Descriptions: pg. 32**)

IMPORTANT!
Always check the TID before firing!
Wasting friendlies isn't usually considered a good thing.

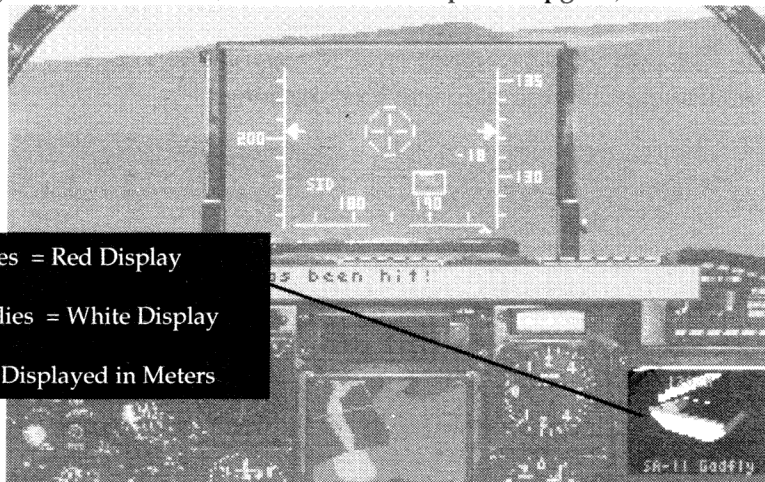

Enemies = Red Display
Friendlies = White Display
Range Displayed in Meters

Simulation Systems

Along with the main cockpit and its instruments, there are several screens and menus that are available from the simulation mode that will prove very beneficial to a successful mission. (See **Game Overview: pg. 10**)

Strategic Map

Pressing "M" during the simulation brings up the strategic map. This is the main source of information on the flow of the battle during the course of each mission. Each target shown on the map can be selected by cycling the current target box until it is placed over the desired target. Cycling of the target box can be done in two ways:

- 1) By depressing the arrow hot pads in the lower right of the screen.
- 2) By clicking on the desired target with the on-screen cursor using a mouse.

Once a target is selected, the Strategic Map will provide a description of the designated target. This description includes:

- Target Type
- Target Location (in Grid Coordinates)
- Target Heading
- Target's Estimated Speed
- Target's Bearing relative to the A-10s current position
- Target's Distance relative to the A-10s current position
- Intelligence Reports (if any) on the target

All Enemy Targets are displayed in Red while Friendly Units are shown in Blue.

Strategic Map Icons

The Strategic Map uses several different types of icons to represent a variety of targets. Following is a listing of all icons used and their meaning.



SAM (surface-to-air missile)



Ground Unit, truck patrol, convoy



Installation (Base, Bridge, Building)



Player (A-10)



Aircraft (Helicopter or Plane)



Truck Convoy

IMPORTANT:

The currently selected target becomes a directional guide for the Destination Marker on the HUD. Following the Destination Marker will lead directly to the last target selected on the Strategic Map. (See Destination Marker: pg. 20)

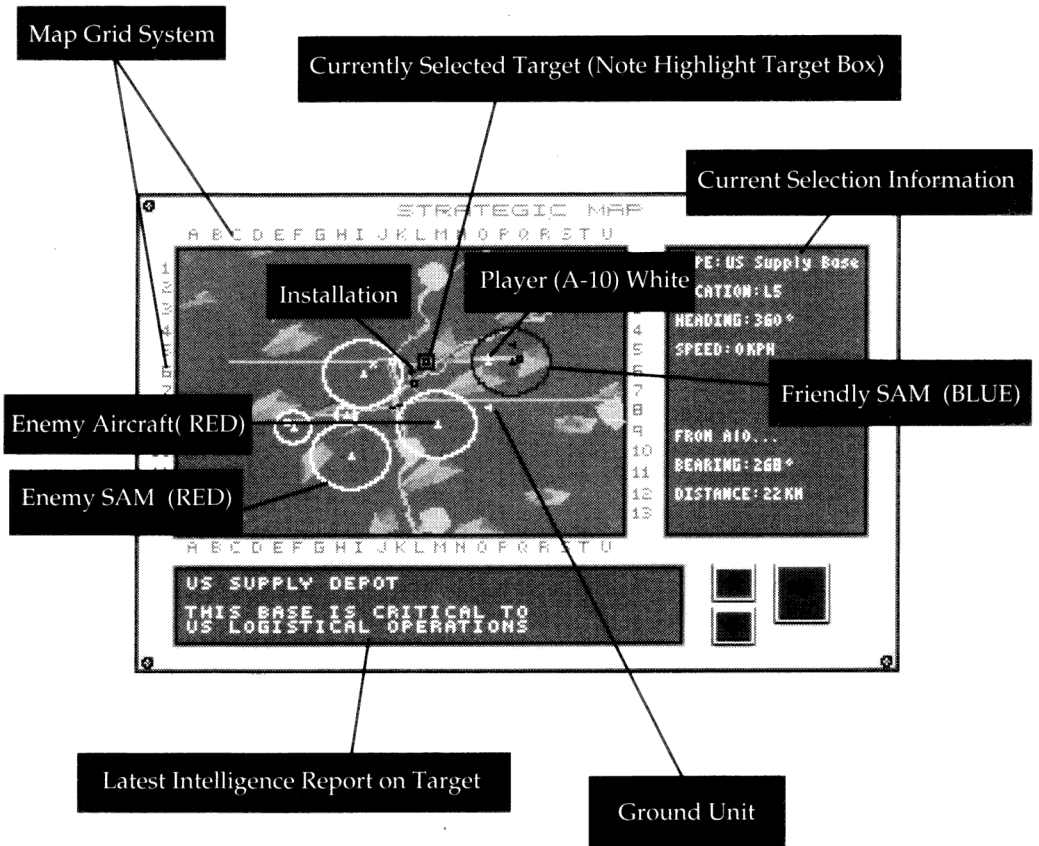

NOTE:

Pressing "S" in the Strategic Map toggles the display of the SAM ranges on and off. (See Controls: pg. 8)

Status Screen

"S" brings up the A-10 Status Screen. This screen graphically displays the amount of damage sustained by the A-10 and shows its remaining armaments, gun ammunition, chaff and flare salvos. (For reference See: Weapons Systems: pg. 30)

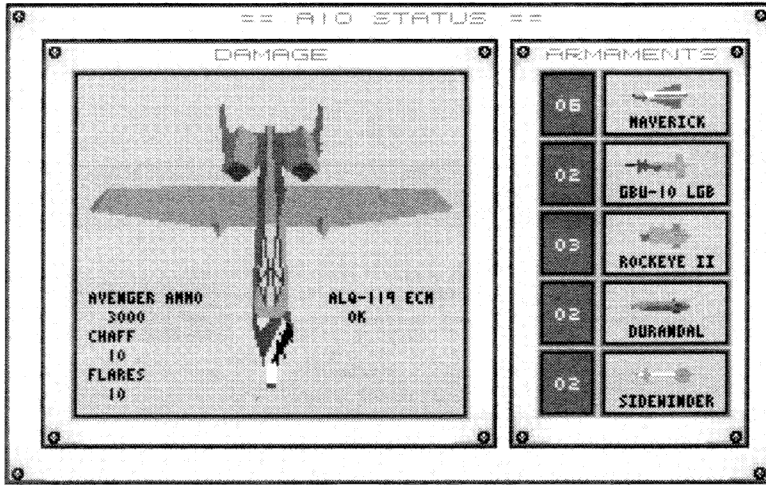

IMPORTANT
If the A-10 loses a wing, all the weapons on the wing are lost with it.

Multiple Views

Along with 3 internal cockpit views, A-10 Tank Killer is capable of displaying 7 external views, including Victim and Engagement Views. (See Controls: pg.8)

Victim View is an external camera that moves to constantly keep a fired weapon and its target in view.

Engagement View is an external camera that pans to keep the enemy and the A-10 both in view.

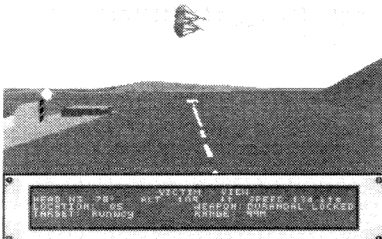

Two Durandals drop toward an enemy airbase as seen from Victim View



The A-10 takes damage from two Migs as seen from Engagement View

VCR Interface™

In a constant effort to make our games more enjoyable and less frustrating, we have developed a new type of game control called the VCR Interface™. In essence, the VCR Interface™ is a menu that is accessible at any time during simulation play which allows you to control vital elements of game play. The interface will have different appearances in different games but the function will always be the same: to give the user as much control as possible over game functions and flow. In A-10 Tank Killer, the VCR Interface™ is seen in two places. The interface is accessible while in the **Mission Select Menu** and in the **Control Menu** (see below). In the **Mission Select Menu** it allows you to customize the difficulty of each mission. In the **Control Menu**, it gives you in-game control over the detail of the 3-D world, the size of the viewing window, the length of time that messages are displayed on screen and basics such as game sound. The **Control Menu** can be accessed at any time by simply pressing the "ESC" key. (See Controls: pg.8. See also Menu Controls: pg.12)

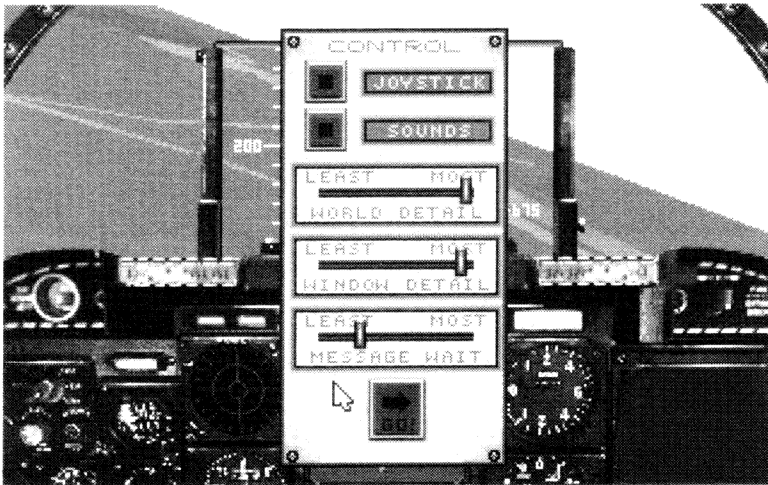

World and Window Detail Slider Bars

What they do: Because A-10 Tank Killer uses a highly advanced 3-Dimensional modeling system called 3Space™, older computers may have some difficulty handling the complex mathematical equations that are necessary to drive the detailed 3-D worlds. The Detail Slider Bars allow you to customize the detail of the game to fit the speed of your computer. By using the Slider Bars, you can "adjust" the amount of detail in the cockpit or in the 3-D world. (See Menu Controls: pg.12)

NOTE

Whenever any of the Simulation System screens are called up, the game is paused.

The Quit Menu

At any time during game play, if the "Q" key is pressed the **Quit Menu** will appear. This menu presents you with two options: **Return To Base** or **Continue Flying**. Selecting **Return To Base** will place you directly into your Mission Debriefing. Selecting **Continue Flying** will re-enter the simulation.

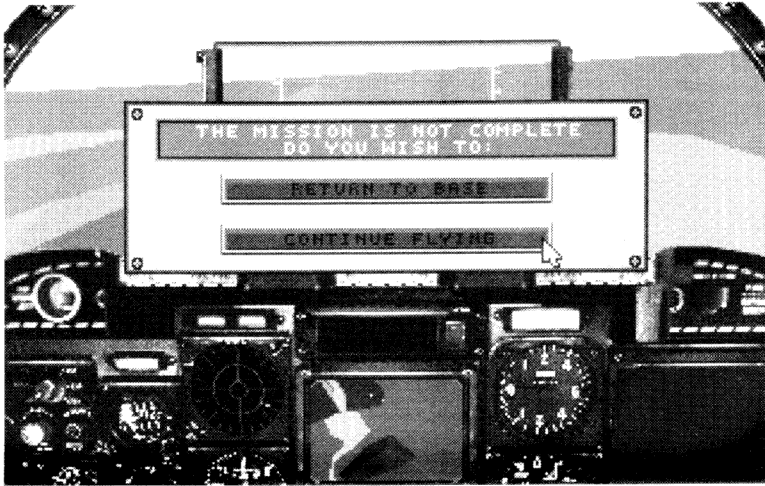

IMPORTANT

There are two ways to quit the simulation: with the battle Complete or Incomplete. Quitting an Incomplete mission will leave any remaining Allied troops open to attack. If this happens your Mission Evaluation may suffer. (See Mission Summary: pg. 17)

A-10 Pilot's Manual

A-10 Warthog Specifications:

Manufacturer:	Fairchild Republic Co.
Primary Mission:	Sustained close air support
Powerplant:	Two General Electric TF34-GE-100 turbofan engines, each developing approximately 9,000 lbs (4,082 kg) of thrust.
Length:	53 feet, 4 inches (16.25m)
Height:	14 feet, 8 inches (4.47m)
Wingspan:	57 feet, 6 inches (17.53m)
Internal Fuel Capacity:	10,700 lbs (4,853 kg)
Operating Weight:	25,000 lbs (11,340 kg)
Max Gross Weight:	50,000 lbs (22,680 kg)
Ammunition Capacity:	5,000 rounds: Mixed HE and depleted Uranium
Armament:	One 30 mm. General Electric GAU-8 Avenger seven barrel cannon.
Firing rate:	2100/4200 rounds per minute
Ordnance capacity:	Up to 16,000 lbs (7,257 kg) of mixed ordnance on ten underwing pylon stations with partial fuel.
Ferry Range:	2,173 nautical miles (4,026 km)
Combat Radius w/ typical weapon load:	250 nm
Max Speed (clean):	450 kt.
Combat Speed w/ typical weapon load:	380 kt.

OVERVIEW OF THE A-10 AND ITS ROLE

The A-10 is a Close Air Support attack aircraft. It assists ground troops by eliminating threats such as hostile tanks, tank destroyers, and other armor. Its extensive weapon load enables it to take out larger targets such as bridges, airstrips, and buildings.

In Viet Nam it was found that an aircraft must be able to survive several SAM hits. The A-10 is built with redundant structural parts so that it can take a lot of damage. In fact, an A-10 can fly with one engine and half a wing blown off! The engines are placed high on the aircraft to protect them from missiles. The bath tub of armor around the cockpit can withstand 20mm rounds.

The most striking feature of the A-10 is its 30mm cannon, the Avenger. It fires shells the size of milk bottles at a rate of 4200 rounds/minute! The shells can rip through the armor of any tank in service. The A-10 hits very hard indeed.

WEAPONS SYSTEMS

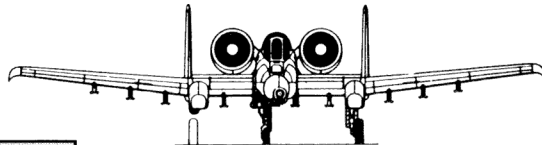

Avenger 30mm Cannon: Effective against: TANKS, VEHICLES

The GAU-8 "Avenger" is the most powerful gun ever mounted on an aircraft. It can fire 2.5 lb depleted uranium shells at a rate of 4,200 rounds/minute into a target 4,000 feet away with 80% accuracy. The energy of these rounds fired is enough to rip through the armor of any Main Battle Tank currently in service.

Anything that moves on the battlefield can be annihilated by the firepower of this awesome weapon.

Maverick: MAV Effective against: TANKS, VEHICLES

The Hughes Aircraft AGM-65D IIR (Imaging InfraRed) Maverick is a fire and forget air-to-ground missile system capable of engaging targets at ranges of up to five miles under ideal conditions. The Maverick's infrared heat seeker locks onto the heat emitted by the target vehicle; this enables it to home in on a target without guidance from the aircraft once it is launched. The Maverick's armor piercing warhead can vaporize the armor of any tank currently fielded by the Warsaw Pact. Operationally, the Maverick is a very lethal system, obtaining an 85% kill probability in weapons trials. Any vehicle or grounded aircraft can be taken out with Mavericks.

Paveway Laser Guided Bomb: LGB Effective against:

**BRIDGES, BUNKERS
BUILDINGS,
INSTALLATIONS**

Another precision munition carried by the A-10 is the Texas Instruments GBU-10E Paveway II Mk 84 laser-guided 2,000 lb. bomb. The Paveway is basically an 'iron bomb' with a laser seeker and control surfaces added. A typical attack profile is as follows: The pilot locks onto a target illuminated by a ground or air based laser using the A-10s Paveway acquisition pod. Then he releases the weapon which glides to the target on its own, making mid-flight corrections as needed. Paveway is most effective against hard targets such as bridges, hardened aircraft revetments, and large buildings.

Honeywell Mk 20 Rockeye II Cluster Bomb: ROC

Effective against: **VEHICLES**

Despite the addition of a laser seeker on the newest versions, Rockeye is not considered a precision munition. The Rockeye relies on the 'scatter effect' of up to 150 armor piercing and high explosive bomblets to destroy its target. Anything within its lethal radius (about 500 feet) is certain to be damaged, and stands a fair chance of being totally destroyed. The Rockeye is most effective against lightly armored vehicles, (BRDM 3s, ACRVs, Mobile SAM launchers, grounded aircraft) but a lucky hit can kill a tank.

Matra Durandal Anti-Runway penetration Bomb: DUR

Effective against: **AIRSTRIPS**

The Durandal is a very specialized weapon that is devastatingly effective against certain types of ground targets. It consists of a large HE (high explosive) warhead encased in a steel jacket attached to a rocket engine. After launch, the ordnance releases a drag chute and falls until it is pointing straight down. Then the rocket motor fires, driving the Durandal deep into the target where it detonates. This explosion causes a huge 'heave effect' which can shatter reinforced concrete and make a runway unusable with only a single hit. In addition to runways, the Durandal is particularly effective against bunkers and underground fuel tanks.

AIM 9L Sidewinder: SID

Effective against: **AIRCRAFT**

The AIM 9L Sidewinder is an air-to-air heat seeking missile with all-aspect tracking capability; this enables the missile to lock onto an enemy plane even if it's nose-to-nose with the A-10. The effective range for a sidewinder is about 5 miles.

VEHICLE DESCRIPTIONS

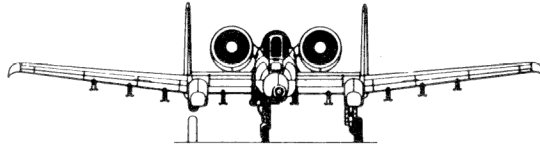

HOSTILE UNITS

(See Tactical Information Display: pg 23)

T-72, T-80 Main Battle Tank

Primary armament: 125mm cannon

Top speed: 60km/h

Threat to the A-10: none

The T-80 is a threat to anything on the ground. Its powerful 125mm cannon can take out other tanks, tank destroyers, SAM launchers, and buildings. The Avenger and Mavericks are the best way to engage it, although a Rockeye will sometimes destroy it. The A-10 'Tank-Killer' was designed to take out tanks like the T-80.

BMP-2 Infantry Fighting Vehicle

Primary armament: 30mm cannon

Top speed: 63 km/h

Threat to the A-10: none

The BMP-2 is a lightly armored, tracked vehicle. It is designed to carry troops on the battlefield. Its small cannon allows it to engage lightly armored vehicles like trucks, but it's no match for a tank. Engage it with the Avenger, a Rockeye, or a Maverick.

ACRV-2 Command Vehicle

Primary armament: none

Top speed: 58 km/h

Threat to the A-10: none

The ACRV-2 is lightly armored, tracked vehicle designed to serve as a mobile command post. It is unarmed. Engage it with the Avenger, a Maverick, or a Rockeye.

BRDM-3 Tank Destroyer

Primary armament: Anti-tank missile

Top speed: 90 km/h

Threat to the A-10: none

The BRDM-3 presents a great threat to any friendly tanks. Its weapon range is greater than that of the M1 Abrams. Engage it with the Avenger, a Maverick, or a Rockeye.

Zil-157 Truck

Top speed: 90 km/h

Threat to the A-10: none

The Zil-157 is the standard Soviet truck. It's used to transport troops, supplies, ammunition, and equipment.

SA-6 Gainful, SA-11 Gadfly SAM Launchers

Primary armament: Surface-to-Air Radar-Guided Missiles

Top speed: 58 km/h

Threat to the A-10: Great

The SA-6 and SA-11 are mobile surface-to-air missile launchers. The missiles track the A-10 with a radar guidance system. The system can sometimes be fooled by dropping chaff which distract the missile away from the A-10. The missiles do great damage to the A-10. The SA-11 has a much greater range than the SA-6. Engaging a SAM with the A-10 is dangerous, but can be done with the Avenger, a Maverick, or a Rockeye.

For more information See: **Defensive Weapons Systems: p. 35 and Tactics Against SAMs: p40).**

SA-9 Gaskin, SA-13 Gopher SAM Launchers

Primary armament: Surface-to-Air Infrared-Homing Missiles

Top speed: 90 km/h

Threat to the A-10: Great

The SA-9 and SA-13 are mobile surface-to-air missile launchers. The missiles home-in on the A-10 with an infrared heat-seeking system. They can sometimes be distracted by dropping a flare. These systems have a smaller range than their radar-guided counterparts (the SA-6 and SA-11). Engaging a SAM with the A-10 is dangerous, but can be done with the Avenger, a Maverick, or a Rockeye.

For more information See: **Defensive Weapons Systems: p. 35 and Tactics Against SAMs: p40).**

Mi-24 Hind Assault Helicopter

Primary armament: 23 mm cannon

Top speed: 170 knots

Threat to the A-10: none

The Hind is a fast, assault helicopter. It presents a great danger to your friendly ground forces. It is particularly effective against the M1 Abrams. It can be engaged with a Sidewinder, and skilled A-10 pilots can shoot it down with the Avenger.

MiG-27 Flogger Strike Fighter

Primary armament: A variety of weapons mounted under the fuselage, including anti-aircraft missiles and bombs.

Top speed: 980 knots

Threat to the A-10: Great

The Flogger can engage anything on the battlefield or in the air. Its air-to-air missiles can pose a serious threat to the A-10. It can be engaged with a Sidewinder, and a lucky Avenger shot could damage it.

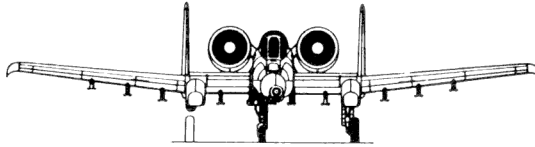

FRIENDLIES

M1 Abrams Main Battle Tank

Primary armament: 120mm cannon

Top speed: 70 km/h

The M1 Abrams is effective against most ground targets. The A-10 should provide close-air support for the M1, especially when there are tank destroyers or Hind helicopters in the area.

M2 Bradley Infantry Fighting Vehicle

Primary armament: 25mm chaingun

Top speed: 65 km/h

The M2 is the US counterpart of the BMP-2. It can engage lightly armored targets, but should avoid one-on-one confrontations with tanks.

M48 Chaparral SAM Launcher

Primary armament: Surface-to-air Infrared-homing missile

Top speed: 60 km/h

The M48 is the standard air defense weapon system of the US. It can take out Hind helicopters and MiG-27 Floggers. When the A-10 is threatened by a MiG, ducking beneath the 'umbrella' of an M48 is a smart move.

Farms

Farms are considered neutral civilian targets, and should not be attacked.

Bridges, Buildings, Supply Dumps, Bases, etc.

Structures such as these can be engaged with the Paveway LGB. However, before dropping an LGB on one, make sure that the mission objectives call for it to be destroyed. Taking out a bridge which US forces plan on crossing is not a smart tactic.

Airstrips

Airstrips controlled by the enemy can be destroyed with the Durandal.

Defensive Weapon Systems

ALQ-119 ECM Jamming pod: This pod hangs on the outside pylon of the left wing of the A-10. It has jammers which can temporarily confuse the radar-acquisition systems on SAM launchers. This gives the A-10 pilot a little extra time before hostile SAMs launch. Jammed launchers are indicated by a blinking dot on the RWR.

Flare: This is a small heat-emitting decoy that the A-10 pilot can release. It will sometimes fool an incoming infrared-homing SAM into tracking it instead of the A-10. It's useful against the SA-9 and SA-13.

Chaff: This is a cartridge which releases a cloud of small tin-foil strips. The cloud will reflect enemy radar and blind it for a few seconds. This will sometimes give the A-10 enough time to escape an incoming radar-guided SAM (such as the SA-6 and SA-11).

(See Radar Warning Receiver: pg. 21)

FLIGHT INSTRUCTIONS

(See Controls: pg. 8)

—— The Take Off ——

In most of the missions you will start off on the runway. Taking off is simple: Give the A-10 full throttle, and pull back on the stick. When you have enough speed, you'll lift off. With less than full throttle, you may run out of runway. Even this is rarely fatal. Recently an A-10 of the 81st Tactical Fighter Wing missed its takeoff and crashed into a beet field. The A-10 sustained very little damage.

—— Landing ——

It is not necessary to land in A-10 Tank Killer. You may quit at any time by pressing Q. This will end the mission and return you to base safely.

If you want to experience a landing, here's how. Line up about 4000 meters from the runway, flying in parallel toward the runway. Use the rudder to make small adjustments to your heading to get lined up exactly. Bring your throttle down to 3. Come to an altitude of about 100 feet and guide the A-10 in. Your copilot will automatically drop the flaps and landing gear for you. Once you set down, bring throttle down to 1.

—— Taxiing ——

If you land, and the mission isn't over you'll want to take off again. To do this, you'll need to turn the A-10 around so you have enough runway. To taxi use a little throttle. For convenience, you can guide the A-10 on the ground with the rudder or aileron controls.

—— Flight ——

Aircraft are guided by control surfaces on the wings and tail, and by the amount of thrust generated by the engines. Ailerons on the wings control the roll of the A-10, and indirectly the heading. The tail controls the pitch, and the rudder controls the heading.

Climbing and Diving

To gain altitude, go into a climb. Just pull back on the stick until the A-10 is oriented upward (positive pitch). Continue climbing until you reach the altitude you want. A dive is just the opposite. Push forward on the stick to lose altitude.

Turning

There are several ways to execute a turn. The simplest way to turn is to move the stick left (or right). This will bank the A-10 slightly and will begin a turn. The more you bank, the more the A-10 will turn. When you've almost reached the heading you want, level the A-10 off.

A faster turn can be executed by moving the stick to the left (or right), and then pulling it back. This is the fastest way of changing heading. However it's very easy to overshoot the heading you want, and unless the A-10 was rolled exactly 90 degrees, you will also change your pitch.

Small adjustments to the heading can be made with the rudder. Using the rudder is the slowest way to turn, but it doesn't affect the pitch and it's the most precise. Usually you'll want to start a turn by moving the stick left (or right), get close to the heading you want, level the A-10 off, and then make the final adjustments to heading with the rudder.

Speed and Stalls

Speed is controlled by the throttle. Full throttle, Full speed. A stall happens when the plane is moving through the air too slowly. Lift is lost and the control surfaces don't work properly. The A-10 will nose down until the air speed is greater than the stall speed. To avoid stalls, keep the throttle at 4 or higher. Don't stall at low altitude unless you enjoy crashing.

COMBAT TACTICS

The A-10 is a special kind of aircraft—it's a combat aircraft armed to the teeth.

Finding the Target

Find the target you want on the Strategic Map, and then select it (**See pg. 24**). You can select it by either positioning the arrow over it and clicking on it, or by sequencing through all the targets with the arrow buttons. The selected target will be highlighted on the map by a black square around it. The information display on the right will give you the bearing and distance of the target from your current position.

Return to the front cockpit view (**F1**). The destination indicator above the compass tape on the HUD will guide you to the target (**See pg.20**). Just change your heading until the destination indicator (a small triangle) is centered on the tape. You are now heading directly towards the target. Stay low, and go full throttle and you'll reach the target. When you get near the target, it should appear in the TID screen. (**See pg. 23**)

Attack Tactics

When you're about 7000 meters from the target, slow down to attack speed—a throttle setting of 3 or 4. This will give you enough time to line up on the target.

Select the proper weapon type to use against the target.

Against Tanks: Select Avenger 30mm cannon, or select a MAVerick.

Against Other Vehicles: Select Avenger, MAVerick, or ROCKey cluster bomb(especially if there are several vehicles close together).

Against Bridges, Bunkers, Buildings, or Installations: Select LGB.

Against Airstrips: Select DURandal.

Against Aircraft: Select SIDewinder.

An Avenger Attack Run

The Avenger is an unguided weapon, it's mounted inside the fuselage of the A-10. You must position the sight over the target and fire. To set up a run, stay low (about 150 feet) and come in at slow speed. Line up on the target. Use the rudder to get lined up exactly on the target. Stay lined up, and at about 3000m, pitch the plane so that the cross hair is exactly over the target. Fire!

If there are several targets before you, use the rudder to spread the Avenger fire across them. Often you can eliminate an entire tank platoon in seconds!

Another useful tactic to score a hit is 'Walking the Fire' across the target. When the cross hairs are below the target, begin firing. Pull the impact point of the shells across the target by pulling back on the stick.

If you miss some of the targets on the first run, make a second pass. Fly past the targets at full throttle for about 7 seconds. Throttle back down to a slower speed, and wheel the A-10 about with either a quick turn or a loop and half-roll. Line up again and finish off the target!

Other Weapons

The other weapons are simpler to score a hit with. Keep the target in the HUD. Sequence through all the targets on the HUD until the one you want is displayed in the TID and is selected on the HUD. Make sure the proper weapon type is selected. When the target is within range, a LOCKED will appear on the HUD next to the weapon type.

To see the full force of the attack switch to one of the cinematic views (F8, F9, or F10) .
(See A-10 Views. pg. 8)

The LGB and Rockeye are guided bombs, whereas the Maverick and Sidewinder are missiles. With the LGB and Rockeye, the lock-on range is smaller.

Avenger vs. Maverick

Both weapons have the same purpose: To Kill Tanks. You'll have to decide which to use on each attack run. The Maverick is easier to use. Select the target you want on the TID, wait for LOCKED, and fire. The guidance system will ensure the Maverick hits the target. The Maverick has a greater range than the Avenger cannon, however, you have fewer Mavericks than Avenger bursts.

If you pop up over a hill and there's a SAM staring at you, it's better to take it out with the Avenger. Avenger shells are faster than a Maverick, and in quick draws like this the Avenger comes out on top. Trying to quick draw on a SAM with a Maverick is risky at best.

The Avenger is the most cost effective way to kill tanks. An Avenger burst costs a fraction of a Maverick missile.

Dogfights

Although the A-10 was not designed for dogfighting, A-10 pilots do not consider MiGs an unconquerable threat. At high altitudes the A-10 is at a distinct disadvantage, but at low altitudes a MiG has a hard time maneuvering.

When you spot a MiG, keep him in front of you. If you have a Sidewinder, fire it as soon as you achieve lock-on. At close ranges, you can try to hit the MiG with an Avenger burst—but this is very difficult. If you're out of Sidewinders, mister you're in trouble. Your best chance is to stay low, drop flares when necessary, and run toward the 'umbrella' of a friendly SAM. If the MiG follows you into the 'umbrella', there's a good chance it will be shot down.

The A-10 can clean up against Hind helicopters. The Hind was not designed for air-to-air combat. You can use Sidewinders against a Hind, or use the Avenger. The Hind is much slower than a MiG, and with practice a good pilot can take out a Hind quickly with the Avenger.

Defensive Tactics Against SAMs

Stay low. The lower you fly, the greater the chance that the terrain will hide you from SAM launchers. Use the Strategic Map to stay outside the range of SAM launchers. Monitor the RWR to see what SAM threats are out there.

When a SAM is coming at you, there are some tactics to try. If there's a hill nearby, duck behind it. If the SAM is radar guided (indicated by the right most light above the blinking RWR), drop some chaff to distract it. If it has Infra Red homing (indicated by the left most light above the blinking RWR), then drop a flare or two. As a last resort, attempt to out-turn the SAM. This is very difficult.

If you find yourself in a quick draw with a SAM launcher, you can try and take it out with the Avenger before it launches.

MISSION PLAN

In the briefing Commander Cord will let you know what your mission objectives are, and what the priorities are. Once you're in the A-10, review the Strategic Map. It will familiarize you with the battle. Make a Flight Plan. However, due to the dynamic nature of land battles, you'll probably have to alter your Flight Plan several times. You will be receiving new orders and distress calls over the radio during the mission. Stay alert and stay flexible. Always keep your objectives in mind.

What tactics are employed when a SAM is launched at the A-10?

"In the first place, stay low to avoid SAM operators from acquiring the A-10. Once a SAM is launched, make a 3-D break away from the SAM. Additionally, flares can be dropped to decoy IR seeking missiles, and chaff are used on radar guided missiles."

What tactics are used when an enemy fighter, say a MiG, is spotted?

"Keep him in front of you. Don't let him on your tail. You can engage the fighter with sidewinders. Two sidewinders can be loaded on either outside pylon. The gun, although not very effective in shooting down aircraft, is very effective in making the enemy fighter take a defensive stance."

In actual combat, how low would you fly?

"Between 100 and 400 feet."

What's the role of the A-10?

"Close Air Support, we call it CAS. We support ground troops in close proximity, which is defined as operating within 1000 yards of friendly forces."

What's the difference between the role of the A-10, and the role of an attack helicopter?

"The roles are identical. Both aircraft provide Close Air Support. However, the capabilities of an attack helicopter are different."

In what way?

"Hiding for example. A helicopter hides by hovering low behind some trees, or by actually landing in an open field. The A-10, since it must keep moving, would hide by flying low behind a ridge line or hill. Helicopters are not as survivable as the A-10. One or two hits on a helicopter will generally cripple it, whereas the A-10 was designed to take hits. In Viet Nam, aircraft were hit quite a bit, so survivability was an important factor. Also, the A-10 can carry much more ordnance. Helicopters carry about 2,000 lbs. The A-10 can carry 15,000 lbs."

The F16 is a ground attack aircraft, what's the difference between the A-10's role and the F16's role?

"The F16 is a fast aircraft. It is used for deep interdiction strikes into enemy territory—taking out a bridge behind enemy lines, for example. It can get in, strike, and get out. The A-10 can fly much slower than the F16. This is essential for Close Air Support. A-10 pilots can operate in a dynamic environment, where targets are moving rapidly and are well camouflaged. An A-10 pilot can spot a ground unit, identify it, wheel about, and destroy it. An F16 pilot can't do that."

What would a typical mission consist of?

“In an actual war, say in Central Europe, an A-10 pilot would go out and fly low to a contact point. At the contact point, the pilot would talk to a ground commander, who might say ‘Four enemy tanks were spotted in the open moving south bound at xx coordinates, and travelling at a speed of y. You’re cleared to go ahead and engage them. The contact would also let the pilot know what SAM threats are in the area, and what friendlies he should expect to see.”

What’s it like to fire the gun?

“The gun is very loud. It shakes the entire aircraft. You never get used to it.”

DESIGN NOTES

Our motivation for doing this product was the A-10 itself. It is perfect material for a high paced challenging simulation. The A-10 is designed to fight in a high threat environment, where the fronts of two armies meet. In the midst of all this chaos, an A-10 pilot has to make snap tactical decisions and adjust his plans according to the dynamics of the battlefield situation.

The A-10 has a lot of personality. Officially it's called the Thunderbolt II, but fliers call it the Warthog. A-10 pilots are called 'Hog-drivers'. Ground troops refer to the A-10 as the Devil's Cross. Due to its shape, tank commanders have a hard time telling if it's flying away or approaching. It's no wonder that this makes them nervous...the Avenger cannon can rip a tank apart in seconds.

In building **A-10 Tank Killer**, we wanted to create an experience that captured the personality and feel of the A-10. We especially wanted to create an experience that *felt like the real thing*. We did extensive research on the plane itself (flight specifications, weapon data, etc.) to get the simulation accurate. But numbers don't tell you what it's like to really fly an A-10. So, we interviewed A-10 pilots to get a human perspective on the experience. One pilot remarked "Flying the A-10 is fun. Can you get that across in your simulation?" We'll leave that question up to you.

We wanted **A-10 Tank Killer** to be entertaining. That's why we chose to compress time. It keeps the pace high. All the dull moments spent ferrying back and forth to the front are squeezed out with time compression. We also chose to go with a two-seater A-10. There aren't very many of them in service, but we felt it was important to have that colorful talk that you get from your co-pilot.

In order to pull this product off properly, we had to overcome a lot of challenges. We optimized our 3-D graphics package for the fifth time in four years. We wrote several 256-color drawing routines which were faster than our 16-color drawing routines. And, we developed a digitizing process involving a photo-lab, real actors, costumes, and on-location photo-shoots. This last bit of technology was necessary because we knew that the hand-drawn, cartoonish look seen in most 16 color games wouldn't carry our desire to make **A-10 Tank Killer** *feel like the real thing*. Our graphics had to look real, especially when we were going to be supporting 256 color VGA systems.

We think all of this effort was worth it and we hope that you enjoy playing **A-10 Tank Killer** as much as we enjoyed building it.

Here's to flying...and hitting hard.

Disk Problems

TECHNICAL HELP (MS-DOS ONLY)

If you are having problems with a game disk, try these suggestions before assuming the disk is faulty:

If you receive any of the following messages:

1. "Insert Disk (#)" when you have already inserted that diskette, or have installed the game on your hard disk
2. "Unable to Chain" or if the game locks up at any point
3. "Disk Error"

then you may have memory resident programs loaded into RAM. You will need to boot your system from a diskette containing your operating system only. Follow these instructions to create a "Dynamix Boot Disk."

FORMATTING FROM A HARD DRIVE

A) Place a blank disk in drive **A**.

B) At the **C** prompt, type: **format a:/s**

NOTE: If your **A** drive is a high density drive and you are using double density disks, you will need to type: **format a:/4/s** (for 5.25" disks)

or type: **format a:/n:9/t:80/s** (for 3.5" disks).

FORMATTING FROM A DISKETTE DRIVE

A) Place your DOS disk in drive **A**.

B) At the **A** prompt, type: **format a:/s** (be sure to switch to a blank disk when prompted by the FORMAT program.)

NOTE: If your **A** drive is a high density drive and you are using double density disks, you will need to type: **format a:/4/s** (for 5.25" disks) or type: **format a:/n:9/t:80/s** (for 3.5" disks).

C) Press

D) Respond to the DOS prompts.

Now you should create a CONFIG.SYS file on your Dynamix Boot Disk, with a files=20 statement. Follow these instructions to create this file:

Disk Problems

- A) Type: **a**
- B) Type: **copy con config.sys**
- C) Type: **files=20**
- D) Press **F6**

You should see the message: "**1 File(s) copied**". You will now have to re-boot your computer with your new Dynamix Boot Disk in the drive. Turn your computer off then on or press **Ctrl-Alt-Del**.

If booting your computer with your new Dynamix Boot Disk doesn't clear up the problem you are encountering, call (209) 683-8989 for technical help. Our technical staff will be happy to help you.

TECHNICAL HELP (ALL SYSTEMS)

Technical assistance is only a telephone call away. Call (209) 683-8989, 8 A.M.- 5 P.M. Pacific Time for convenient, person-to-person service, or if you prefer, you may request assistance by mail. If you choose to write to us with your request, please state your computer type and the nature of your problem.

If you find that you need to send for replacement diskettes, send the original disk 1 in the size you need (3.5" or 5.25") to:

Sierra On-Line
P.O. Box 485
Coarsegold, CA 93614
Attention: RETURNS

Be sure to include a note stating your computer type, and the size of diskette you need (5.25" or 3.5").

We will gladly replace your program free of charge for the first 90 days of ownership (please enclose a copy of your dated sales receipt with your request). After 90 days there is a \$5.00 charge for 5.25" diskettes, and a \$10.00 charge for 3.5" diskettes.



A-10: Tank Killer Main Team Front and Center (left to right) Supporting Cast Behind
Randy Dersham, Dave Selle, David McClurg, Lincoln Hutton, Damon Slye, Cyrus Kanga,
Mark Brennemen, Kobi Miller, Bryce Morsello and Sher Alltucker
(special thanks to Atrium Security for making this illegal shot possible)

Over 25 of the industry's best programmers, artists and background crew worked together to bring this product to life. A great many all-nighters, far too many 16 hour days, several dozen delivered pizzas, numerous Tetris™ matches and at least one bunny roast later, this program finds it's way into your hands. We hope that you have as much fun playing this product as we had creating it.



WARRANTY REGISTRATION

Sierra On-Line, Inc.
P.O. Box 485
Coarsegold, CA 93614

PLACE
APPROPRIATE
POSTAGE
HERE



**WARRANTY REGISTRATION
P.O. BOX 485
COARSEGOLD, CA 93614**

**WARRANTY REGISTRATION
PROCESS IMMEDIATELY**

**RUSH ORDER!
PROCESS IMMEDIATELY!**

SIERRA ON-LINE, INC.
P.O. BOX 485
COARSEGOLD, CA 93614

POSTAGE WILL BE PAID BY ADDRESSEE

BUSINESS REPLY MAIL
FIRST CLASS PERMIT NO. 5 OAKHURST, CA

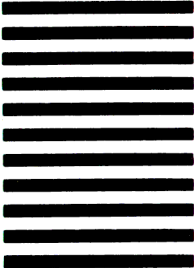

NO POSTAGE
NECESSARY
IF MAILED
IN THE
UNITED STATES

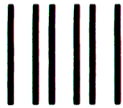

SIERRA ON-LINE, INC.
P.O. BOX 485
COARSEGOLD, CA 93614

A-10TM TANK KILLER

SIMULATION SYSTEMS MODULESTM