

**IREM**  
IREM AMERICA  
CORPORATION

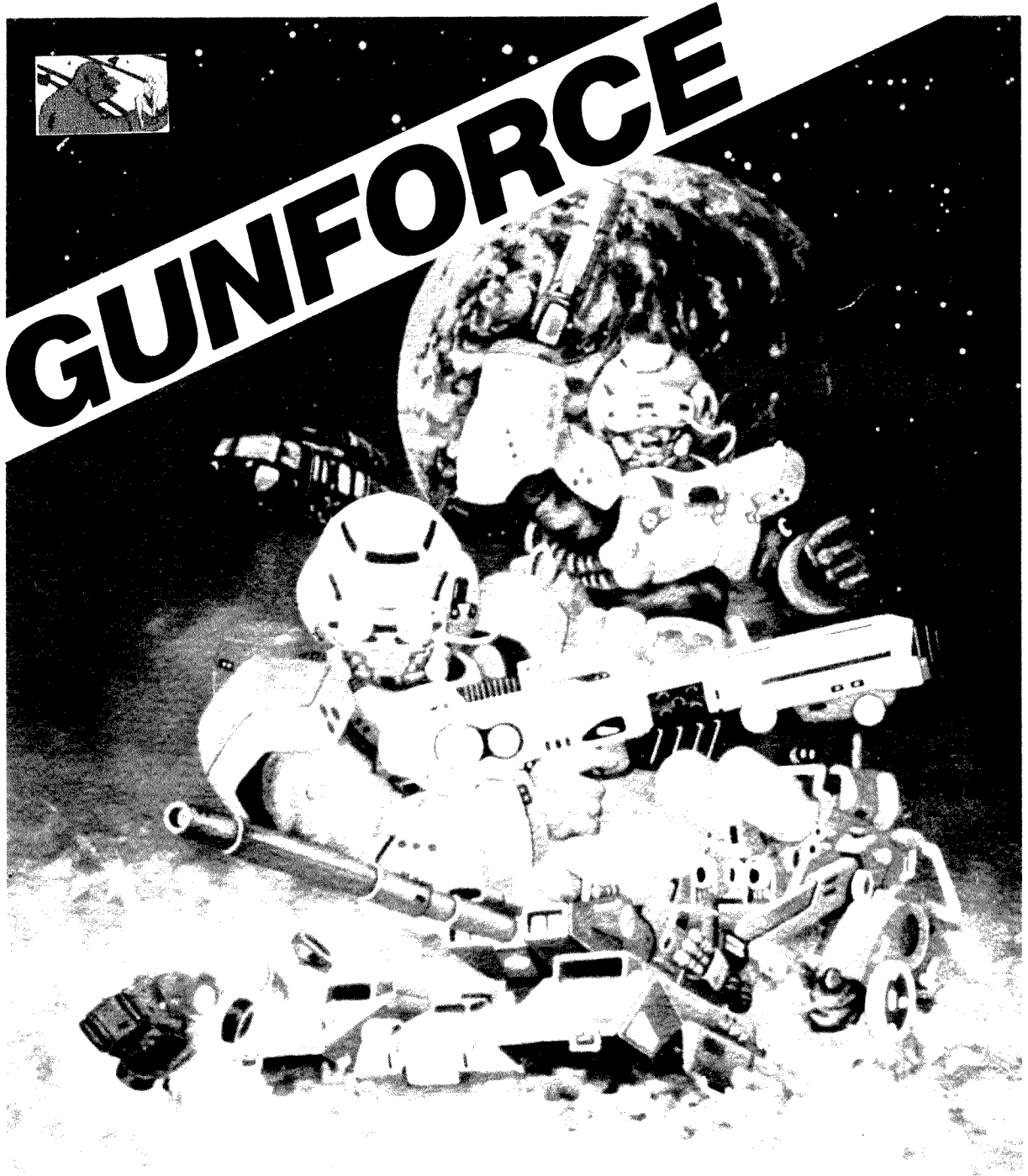

**OWNERS MANUAL — GUNFORCE®**

# VIDEO GAME OPERATOR:

Don't Get Involved In A Federal Crime. Don't Buy Or Operate Copy Or Unauthorized Boards In Your Games.

# Warning



*Every operator who buys or operates a counterfeit or unauthorized board (imported or domestic) is contributing to the end of our industry and committing a FEDERAL CRIME.*

*New criminal laws have recently been enacted that provide for maximum penalties of \$250,000 or five years in prison or both, per offense. EACH GAME IS A SEPARATE OFFENSE.*



## WARNING

Federal law provides severe civil and criminal penalties for the unauthorized reproduction, distribution, or exhibition of copyrighted audiovisual works and video games.

The Federal Bureau of Investigation investigates allegations of criminal copyright infringement.

*If you have any information about any unauthorized games in the United States, contact your local FBI or,*

American Amusement Machine Association

205 The Strand  
Suite 3  
Alexandria, Virginia 22314  
(703) 548-8044

All information will be treated in confidence.

## **SAFETY**

The following topics should be carefully studied to insure maximum reliability and safety for both serviceman and customer. Shock Hazard: The high voltage present on the monitor may be very dangerous. Extreme caution must be used when working with or around the monitors. Be certain that the grounding strap is attached to the monitor frame. The picture tube in the monitor is also a hazard and should be handled with care. Do not strike, scratch, or subject the tube to more than moderate pressure as it may implode causing serious injury from flying glass. Be certain that the control panel, power supply monitor, and coin door are all properly grounded to the ground wire inside the line cord. Do not remove ground prong off plug end.

## **PARTS LIST**

- 1 - Plex Marquee
- 1 - Control Panel Overlay
- 1 - FCC Cage and Label
- 1 - Graphic Package
- 2 - Side Graphics
  - 1 - Manual
  - 6 - Buttons
- 1 - JAMMA Cable
- 1 - Marquee Art
- 1 - Gunforce PCB
- 2 - 8 Way Joysticks & Hardware

### **IREM AMERICA CORPORATION®**

8333 154th Avenue NE  
Redmond, WA 98052  
(206) 882-1093

### **FOR SERVICE CONTACT:**

Your authorized Irem America Corporation® Distributor  
or

**SUMMIT SERVICE**  
2274 University Avenue  
St. Paul, MN 55114  
(612) 645-9077

## **WARRANTY REPAIRS**

Irem America Corporation PCB have a 90 day warranty from date of shipment. This includes all failures except those caused by the installer such as miswiring.

All PCB must be returned by an authorized Irem America Corporation distributor. A Return Material Authorization must be obtained from Summit Service prior to returning material. A Purchase Order must also be given to Summit Service at this time. The package must be clearly marked with the RMA number.

**GUNFORCE®** is protected by federal copyright laws and is the property of Irem America Corporation®. Any unauthorized versions of this game are illegal by federal law. AAMA protected stickers must be attached to the PCB. Please notify Irem America Corporation of any boards not having the AAMA seal.

## IMPORTANT F.C.C. WARNING

THIS EQUIPMENT COMPLIES WITH THE REQUIREMENTS IN PART 15 OF FCC RULES FOR A CLASS A COMPUTING DEVICE. OPERATION OF THIS EQUIPMENT IN A RESIDENTIAL AREA MAY CAUSE UNACCEPTABLE INTERFERENCE OF RADIO AND TV RECEPTION REQUIRING THE OPERATOR TO TAKE WHATEVER STEPS ARE NECESSARY TO CORRECT THE INTERFERENCE. YOUR FCC COMPLIANCE LABEL IS ENCLOSED IN YOUR KIT AND MUST BE ATTACHED TO YOUR GAME PRIOR TO PLACING ON LOCATION. THIS LABEL INDICATES YOUR GAME WAS DESIGNED TO MEET FCC STANDARDS 47CFR15.19. WE ADVISE USING STAPLES IF NECESSARY TO MAKE SURE THE LABEL STAYS ON.

## DANGER

The isolation transformer must be used with the monitor and power supply.

This game must be equipped with a three wire 110 volt plug for safety. Under no circumstance remove the ground plug.

## DANGER

This game is designed with a JAMMA 56 pin connector. This plug is one of the finest operator friendly features in our industry today. What this means to you is that:

- 1) 1, 2, A, B, 27, 28, e and f are grounded
- 2) 3, 4, C and D are +5 volts
- 3) 5 and E are -5 volts
- 4) 6 and F are +12 volts

Also, all video and joystick functions are always in the same place. Once a cabinet is wired for JAMMA, it is easily changed from game to game.

Many older games such as Pac Man®, etc., have the power supply on the board. This will not work!!! Only a JAMMA connector with proper voltage will work. Irem America Corporation® recommends using an 11 or 15 amp switching power supply with **Gunforce®**.

## MONITORS

**Gunforce®** is designed to be operated with a horizontal raster scan monitor with negative sync (RGB). This means **Gunforce®** will not work with any X-Y (Tempest, Space Dual, Star Trec), etc. An isolation transformer must be used in conjunction with the monitor. This is for your safety. The monitor also utilizes extremely high voltages. The monitor may also retain a charge for an extended period of time. Safety goggles must be worn while removing or replacing the monitor.

It is highly recommended that the monitor is verified good before the new **Gunforce®** kit is installed in your new and or rebuilt cabinet.

# INSTALLATION OF KIT IN USED CABINET

## To Disassemble:

1. Open back door and remove old board set and power supply, if you are using a new switching power supply.
2. Remove marquee glass and monitor glass.
3. Remove control panel and set aside.
4. Remove old wire harness, leaving 110 volt wiring intact. Also, leave the grounding straps to the monitor, coin door, control panel, and power supply intact.

## Installation:

1. Mount the board set on the side panel of the cabinet as close to the middle of the game as possible (approximately 10-12" off bottom).

**NOTE: Do not mount board directly below control or any vents or cracks so that liquids may seep on to the board. Do not forget about coins that may drop on to the board. Also, mount the board with edge connector facing up.**

2. Mount the power supply on the bottom of the cabinet with connectors facing the rear of the cabinet. An optional mounting might be on the side panel just below the board set, connector to rear.
3. If the game does not have an isolation transformer, you must protect your customers and your game. Install one between the 110 volt line and your monitor/power supply.
4. Place the provided JAMMA wiring harness on the board. Connect the +5, +12, -5, and ground wires to the corresponding lugs on the power supply, connecting all the wires. If you don't, you will probably burn the board connector.
5. Run a wire from +12 volts to the coin door lights. Run a wire from +12 volts to the coin counters. This completes the power requirements.
6. Connect the Audio (+) and Audio (-) to the speaker.
7. Connect the video red, green, blue, ground, and sync to the corresponding wires on the monitor. If the monitor is not a negative composite sync, see sync modifications chart.
8. Cut the marquee to size. Replace the marquee lamp, if needed. Install the marquee panel.
9. Connect the coin 1 and coin 2 wires to the coin switches. Connect the coin counter 1 and coin counter 2 wires to the coin counters.

**NOTE: If you only have one coin counter, see coin counter diagram. It will not matter if the coin counters are only rated at 6 volts, as the pulse is not long enough to burn out the counter.**

10. Disassemble the control panel of all the hardware. Do not remove the old panel overlay. Determine where to place the new joystick and buttons if they must be repositioned. Then, cut new holes.

**NOTE: If you are going to use plexiglass over the control panel, we suggest that you use a good 1/8" polycarbonate with a scratch resistant coating. We recommend GENERAL ELECTRIC LEXAN MR5 with margard or TUFFAK CM-2. These do not crack or break with abuse.**

Cut and drill plex as needed. Remove the old control panel overlay carefully and apply the new overlay on top of the old glue. Use an **Exacto** knife to cut out any button or bolt holes. Apply necessary decals over appropriate buttons. Now assemble the control panel.

11. Bolt the control panel to the cabinet. Now connect the appropriate wires to the correct switches. Connect the 1 player and 2 player start wires.
12. Be sure to install the FCC cage to avoid unnecessary radio frequency interference.
13. Power up the game. Look over your installation for errors, and then apply power, listening for unusual sounds. Check for smoke or sparks. If everything is okay, wire tie all wires to form a nice, neat wiring harness. Clean the cabinet inside and out. Measure the +5 volts on the furthest point from the edge connector and adjust 5 volts to 5.05 volts. Use a tinted plex over the monitor if there are burns in the screen. We suggest bronze or grey tinted plex. Touch up the cabinet with fresh paint, and then repair all cabinet dents or chips, using an auto body product called **Duraglass**. This is similar to bondo. You can consult your local auto body shop or auto parts supplier for this product, as well as advice on how to use it.
14. Be sure your ground plug is good. All metal exposed to the player must be grounded (coin door, control panel, etc.) including all metal inside exposed to 110 volts.

## GUNFORCE®

Irem America Corporation recommends installing your new **GUNFORCE** kit in only a new or refurbished cabinet. Installing **GUNFORCE** in an older cabinet will result in lower earnings. The cabinet should be as follows:

1. horizontal monitor
2. 11 amp or larger power supply
3. monitor not laying down flat.

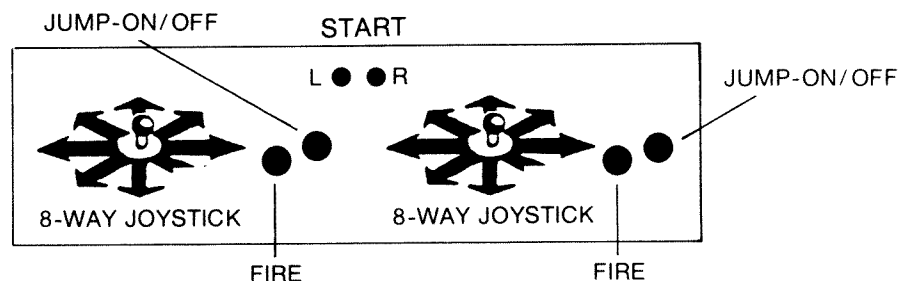

### SPRING ACTION JOYSTICK

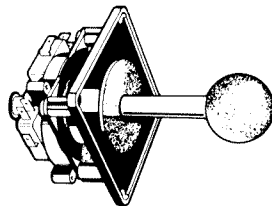

- Featuring:**
- Nylon and solid steel construction
  - Spring return to center
  - Micro or leaf switches individually replaceable
  - Long shaft, 1.5 inch diameter red knob fitted as standard

**MOUNTING DIMENSIONS**

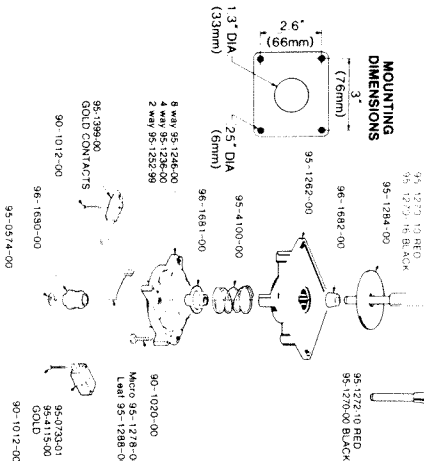

**PARTS LIST:**

90-1020-00	Switch Bracket Screw	95-1270-10	Black 1.5" knob & shaft
90-1012-00	N/S	95-1278-00	Microswitch
95-0574-00	E-Ring	95-1284-00	Leaf switch protector
95-0733-01	Microswitch	95-1284-00	Leaf switch protector
95-1246-00	8-way bracket	95-1399-00	Leaf switch, side mount
95-1246-00	4-way bracket	GOLD contacts	
95-1252-99	2-way bracket	95-4100-00	850 dia spring
95-1270-00	Hub	96-1680-00	Actuator microswitch
95-1272-10	Red 1.25" knob & shaft	96-1881-00	Z-Slip
95-1270-10	Red 1.5" knob & shaft	96-1682-00	Pivot cone

**HAPP CONTROLS, inc.**  
 106 Carlisch  
 Elk Grove, Illinois 60007  
 Phone: (312) 593-6130  
 Fax: (312) 593-6137  
 Telex: 297249 CONTROLS UR

SPRING ACTION JOYSTICK	Price per ea.	1-24	25 +
50-5308-02 8-way microswitch joystick 1.25" knob	12.95	9.95	
50-5304-02 4-way microswitch joystick 1.25" knob	12.95	9.95	
50-4308-02 8-way leaf switch joystick 1.25" knob	12.95	9.95	
50-4304-02 4-way leaf switch joystick 1.25" knob	12.95	9.95	
50-5508-02 8-way microswitch joystick 1.5" knob	12.95	9.95	
50-5504-02 4-way microswitch joystick 1.5" knob	12.95	9.95	
50-4508-02 8-way leaf switch joystick 1.5" knob	12.95	9.95	
50-4504-02 4-way leaf switch joystick 1.5" knob	12.95	9.95	

### SUPER JOYSTICK

- Featuring:**
- Nylon and solid steel construction
  - Micro or leaf switches individually replaceable
  - Unique handle design
  - Spring return to center
  - Rugged actuator for long life
  - Change actuation to 4-way or 8-way simply by flipping actuator over

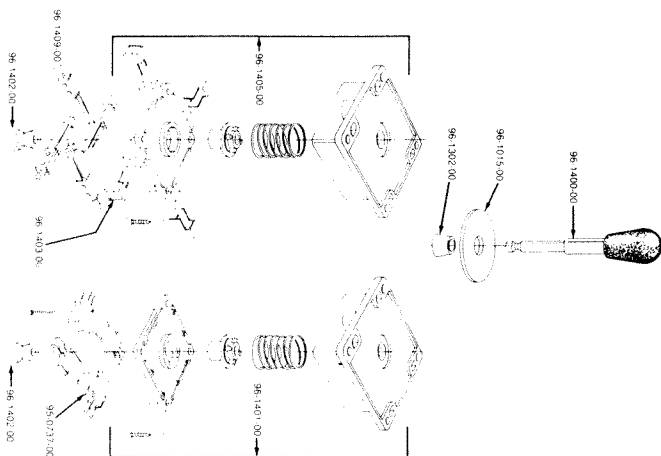
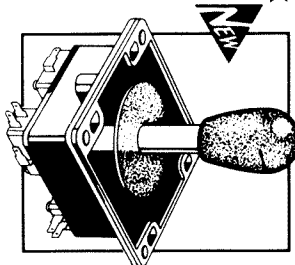

**HAPP CONTROLS, inc.**  
 106 Carlisch  
 Elk Grove, Illinois 60007  
 Phone: (312) 593-6130  
 Fax: (312) 593-6137  
 Telex: 297249 CONTROLS UR

**PARTS LIST**

96-1400-00	Chrome shaft & knob	96-1401-00	Hub for microswitch joystick
96-1015-00	Washer	96-1409-00	Leafswitch
96-1302-00	Pivot cone	95-0737-00	Microswitch
96-1403-00	Blade holder	96-1402-00	4-way 8-way actuator joystick
96-1405-00	Hub for leaf switch		

**SUPER JOYSTICK** Price per ea.

50-6084-00 Super joystick 4-way 8-way	1-24	25 +
50-6085-00 Super joystick 4-way 8-way leafswitch	15.95	13.95

## 1. Monitor Sync

If your monitor does not have dual polarity positions for sync, you may use one of the following methods to get your game going.

CURE 1: Install a simple one I.C. Circuit on your logic board. This I.C. may be "piggy backed" on to another 7404 series chip for power by bending up all but the two power pins so that they are parallel to the top surface of the new I.C. and then connecting the power pins only to the existing chip. (See Fig. 1) Next connect the sync wires as shown in Fig. 2. (Note: Figure 2 shows a hookup for either **composite** or **separate** syncs.)

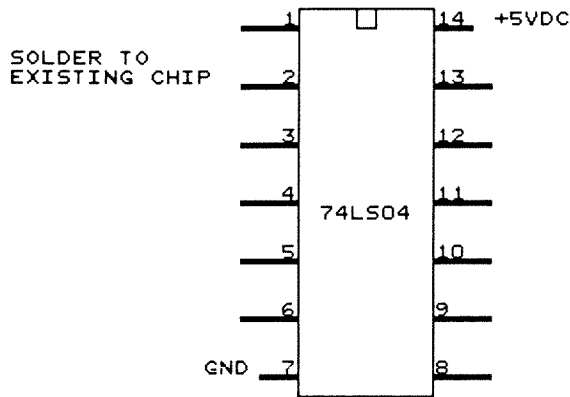

FIG. 1

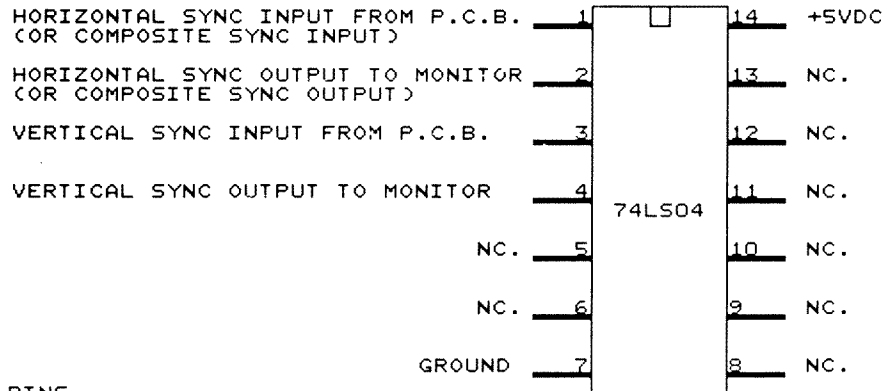
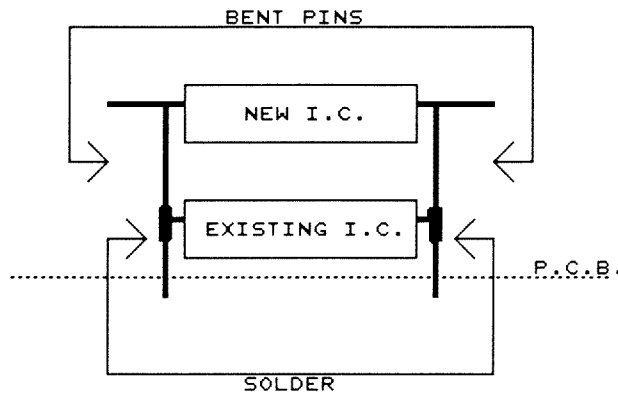

FIG. 2



CURE 2: Used for Wells-Gardner Video-Sync boards with positive sync connections only. (Vertical mount board 85x14 OB.)

Cut the traces on the solder side of the board between input pins 5 & 6 to the unbanded (anode) ends of diodes X201 & X202.

Add MPSA 56 transistor as follows:

Collector to anode leads of diodes X201 & X202. Base pins 5 & 6 of the video input connector. Emitter to cathode (banded) lead of zener diode ZD201.

Insert a 1N4148 diode - cathode to the emitter of the MPSA56 and anode to the base. (See Fig. 3)

FIG. 3

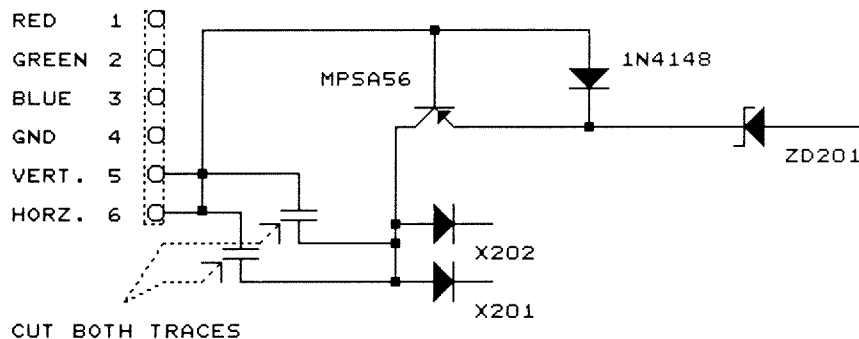



## 2. Horizontal Tearing

CAUSE: The negative sync signal of most logic sets are slightly different than the GO7-CBO monitor negative sync inputs. The result of this mismatch is a horizontal "wave" or "curl".

CURE 1: On the monitor deflection board, replace C303 with a 10uf 25V radial lead capacitor with the positive lead towards the collector of X305. (CAUTION: be sure to check this step as the original cap is not polarized.) Then replace C501 with the cap removed from the C303 location.

CURE 2: Connect 1N4148 fast-switching diodes across both the positive and negative sync inputs to the monitor. (See Fig. 4) NOTE: Both diodes must be installed or you will not have vertical stability.

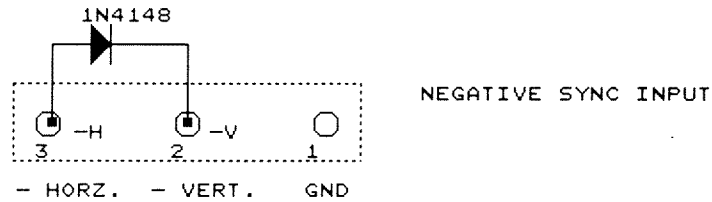
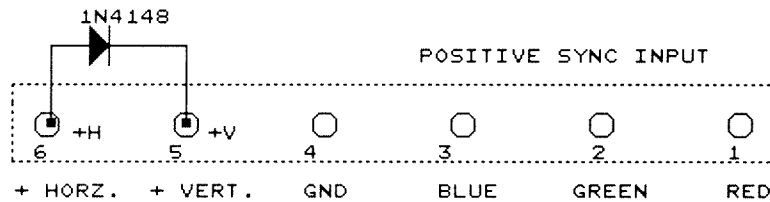

FIG. 4



CURE 3: Join negative sync inputs J2 and J3 together with a jumper. Locate W102 and install a jumper from W102 to either J2 or J3.

CURE 4: For Wells-Gardner K4600 series monitors.

Replace C356 (4 7uf 25V) on the Horizontal/vertical board (*vertically mounted board nearest the flyback transformer*) and center the horizontal hold pot. Turn L351 for the best horizontal stability and fine-tune with the horizontal width pot.

## COIN COUNTER DIAGRAM

If only one coin counter is to be used install two diodes in the following manner:

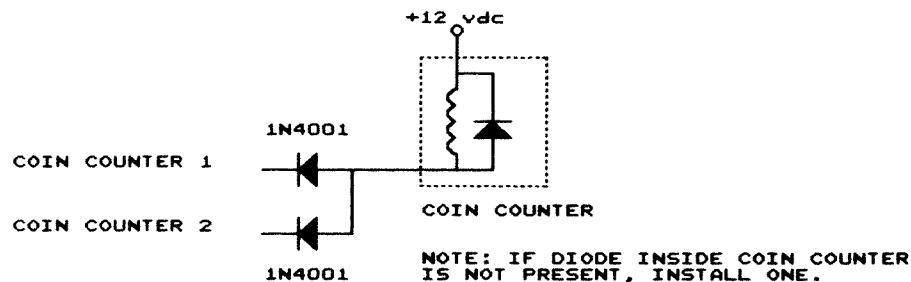

GUNFORCE® — HORIZONTAL SCREEN — 2 x 8 WAY JOYSTICK 2 BUTTONS

DIP-1

FUNCTION		SWITCH	1	2	3	4	5	6	7	8
NUMBER OF PLAYER	3		OFF	OFF						
	2		ON	OFF						
	4		OFF	ON						
	5		ON	ON						
DIFFICULTY	NORMAL				ON	OFF				
	EASY				ON	ON				
	HARD				OFF	OFF				
	VERY HARD				OFF	ON				
THE RATE OF INCREASED POINT	20, 40, 90, 150x10,000						OFF			
	15, 35, 75, 120x10,000						ON			
CONTINUATION MODE	YES							OFF		
	NO							ON		
SOUND IN DEMO	NO								OFF	
	YES								ON	
DIAGNOSTIC TEST	NO									OFF
	YES									ON

DIP-2

FUNCTION		SWITCH	1	2	3	4	5	6	7	8	
FILP PICTURE	NO		OFF								
	YES		ON								
CABINET TYPE	NOT USED			OFF	OFF						
				ON	OFF						
				OFF	ON						
				ON	ON						
MODE 1	1 COIN 1 PLAY					OFF	OFF	OFF	OFF	OFF	
	2 COINS 1 PLAY					OFF	ON	OFF	OFF	OFF	
	3 COINS 1 PLAY					OFF	OFF	ON	OFF	OFF	
	4 COINS 1 PLAY					OFF	ON	ON	OFF	OFF	
	5 COINS 1 PLAY					OFF	OFF	OFF	ON	OFF	
	6 COINS 1 PLAY					OFF	ON	OFF	ON	OFF	
	1 COIN 2 PLAYS					OFF	OFF	ON	ON	OFF	
	1 COIN 3 PLAYS					OFF	ON	ON	ON	OFF	
	1 COIN 4 PLAYS					OFF	OFF	OFF	OFF	ON	
	1 COIN 5 PLAYS					OFF	ON	OFF	OFF	ON	
	1 COIN 6 PLAYS					OFF	OFF	ON	OFF	ON	
	2 COINS 3 PLAYS					OFF	ON	ON	OFF	ON	
	3 COINS 2 PLAYS					OFF	OFF	OFF	ON	ON	
	4 COINS 3 PLAYS					OFF	ON	OFF	ON	ON	
	*CONTINUATION COIN					OFF	OFF	ON	ON	ON	
	FREE PLAY					OFF	ON	ON	ON	ON	
	MODE 2	COIN MECH. (A)	1 COIN 1 PLAY				ON	OFF	OFF		
2 COINS 1 PLAY						ON	ON	OFF			
3 COINS 1 PLAY						ON	OFF	ON			
5 COINS 1 PLAY						ON	ON	ON			
COIN MECH. (B)		1 COIN 2 PLAY				ON				OFF	OFF
		1 COIN 3 PLAYS				ON				ON	OFF
		1 COIN 5 PLAYS				ON				OFF	ON
		1 COIN 6 PLAYS				ON				ON	ON

N.B.

- \* Please operate Dip Switches with Power Switch OFF; otherwise they don't work.
- \* Select Coin Mode 1 in case a single coin selector or two selectors for coins of the same value are used.
- \* Select Coin Mode 2 in case two coin selectors of coins of different values are used.
- \* CONTINUATION COIN makes the game start with 2 coins, and makes the game continue with 1 coin. This mode does not allow any other coin modes to be set.

KD/DYNAMO — UNIVERSAL VIDEO WIRING

56 PIN EDGE CONN. PIN-OUT CHART  
(JAMMA COMPATIBLE)

COMPONENT SIDE			SOLDER SIDE		
FUNCTION	COLOR	POS	FUNCTION	COLOR	POS
GROUND	BLK	1	GROUND	BLK	A
GROUND	BLK	2	GROUND	BLK	B
+5 VOLTS	RED	3	+5 VOLTS	RED	C
+5 VOLTS	RED	4	+5 VOLTS	RED	D
-5 VOLTS	WHITE	5	-5 VOLTS	WHITE	E
+12 VOLTS	YELLOW	6	+12 VOLTS	YELLOW	F
KEY		7	KEY		H
COIN COUNTER #1	BRN	8	COIN COUNTER #2		J
COIN LOCK OUT 1	RED	9	COIN LOCK OUT 2		K
SP (+)	WHT	10	SP (-)	WHT/BLK	L
N.C.	BLUE-OPTION	11	N.C.	OP.-BLU/BLACK	M
VIDEO RED	RED	12	VIDEO GRN	GRN	N
VIDEO BLU	BLU	13	VIDEO SYNC*	GRAY	P
VIDEO GND	BLK	14	SERVICE SWITCH	RED/BLACK	R
TEST SW.	BROWN	15	TILT SW.	OP.-BRN/BLACK	S
COIN SW. 1	WHITE	16	COIN SW. 2		T
START 1	GRAY	17	START 2	WHITE/GRAY	U
1 P UP	VIOLET	18	2 P UP	WHITE/VIOLET	V
1 P DOWN	BLUE	19	2 P DOWN	WHITE/BLUE	W
1 P LEFT	GREEN	20	2 P LEFT	WHITE/GREEN	X
1 P RIGHT	YELLOW	21	2 P RIGHT	WHT/YELLOW	Y
1 P PUSH 1	ORANGE	22	2 P PUSH 1	WHT/ORANGE	Z
1 P PUSH 2	RED	23	2 P PUSH 2	WHT/RED	a
1 P PUSH 3	BROWN	24	2 P PUSH 3	WHT/BROWN	b
N.C.	BLUE/WHT	25	N.C.	GREEN/WHT	c
N.C.	RED/WHT	26	N.C.	YELLOW/WHT	d
GROUND	BLK	27	GROUND	BLK	e
GROUND	BLK-OPTION	28	GROUND	BLK-OPTION	f

GUNFORCE®  
JAMMA EDGE CONNECTOR/CABLE

COMPONENT SIDE			SOLDER SIDE		
FUNCTION	COLOR	POS	FUNCTION	COLOR	POS
GROUND	BLK	1	GROUND	BLK	A
GROUND	BLK	2	GROUND	BLK	B
+5 VOLTS	RED	3	+5 VOLTS	RED	C
+5 VOLTS	RED	4	+5 VOLTS	RED	D
-5 VOLTS	BRN	5	-5 VOLTS	BRN	E
+12 VOLTS	BLU	6	+12 VOLTS	BLU	F
PREVENT KEY		7	PREVENT KEY		H
COIN COUNTER #1	BLU/BRN	8	COIN COUNTER #2	WHT/PUR	J
AUDIO POS +	WHT/BLK	10	AUDIO NEG -	BLK	L
VIDEO RED	RED	12	VIDEO GRN	GRN	N
VIDEO BLU	BLU	13	VIDEO SYNC*	WHT	P
VIDEO GND	BLK	14	SERVICE SWITCH	BRN/WHT	R
COIN INPUT 1	WHT/YEL	16	COIN INPUT 2	WHT/BRN	S
START 1	PNK/BLK	17	START 2	GRN/YEL	T
1 P UP	ORG/BLU	18	2 P UP	RED/BLK	U
1 P DOWN	GRN/ORG	19	2 P DOWN	BRN/BLU	V
1 P LEFT	GRN/BLU	20	2 P LEFT	ORG/WHT	W
1 P RIGHT	RED/YEL	21	2 P RIGHT	ORG/GRN	X
1 P FIRE	RED/WHT	22	2 P FIRE	WHT/ORG	Y
1 P JUMP-ON/OFF	WHT/RED	23	2 P JUMP-ON/OFF	BRN/BLK	Z
	YEL/BLK	24		YEL/WHT	a
		25		BRN/GRN	b
		26			c
GROUND	BLK	27	GROUND	BLK	e
GROUND	BLK	28	GROUND	BLK	f

\* Video sync composite negative.

\* Use 8-way joysticks.

\* Video sync composite negative

# Diagnostic Test

## (1) Test Items

The following tests are made:

- 1 RAM Test
- 2 ROM Test
- 3 I/O PORT Test
- 4 DIP Switch Test
- 5 SOUND Test
- 6 CHARACTER Test
- 7 COLOR Test
- 8 CROSS HATCH Test

As soon as the number 8 of the DIP Switch 1 is turned to "ON" and the Power Switch is switched on, the Test 1 and 2 are started.

To finish the Tests, turn off the Power Switch and then the number 8 of the DIP Switch 1 to "OFF".

## (2) Test Procedures

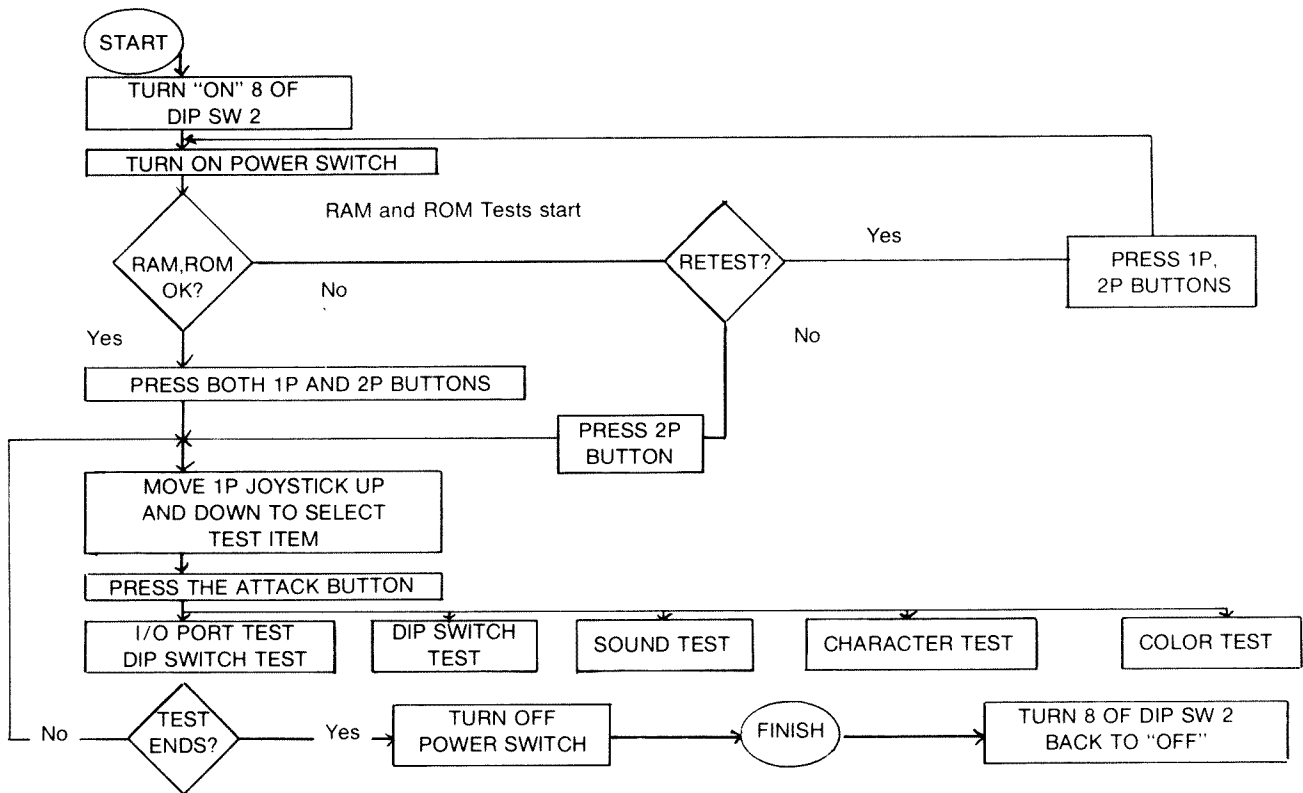

## (3) RAM and ROM TEST

Although the picture does not appear on the screen and only various patterns appear on it for a while after turning on the power switch, RAM's for the picture are being tested during this time. If RAM's are found OK by the test, "RAM OK" and "ROM OK" will be displayed on the screen.

If RAM(s) is (are) not good, "RAM NG  " will appear on the screen.

The figure following the RAM NG" indicates the location of the defective RAM.

- |                               |                                 |
|-------------------------------|---------------------------------|
| 00 WORK RAM (BYTE)            | 09 PALLETE BUFFER BANK 0 (WORD) |
| 01 WORK RAM (WORD)            | 10 PALLETE BUFFER BANK 1 (WORD) |
| 02 V_RAM A (WORD)             | 11 PALLETE BUFFER BANK 2 (WORD) |
| 03 V_RAM B (WORD)             | 12 PALLETE BUFFER BANK 3 (WORD) |
| 04 V_RAM C (WORD)             | 13 OBJECT BUFFER BANK 0 (WORD)  |
| 05 V_RAM D (WORD)             | 14 OBJECT BUFFER BANK 1 (WORD)  |
| 06 RASTER SCROLL RAM A (WORD) | 15 PALLETE RAM BANK 0 (WORD)    |
| 07 RASTER SCROLL RAM B (WORD) | 22 PALLETE RAM BANK 7           |
| 08 RASTER SCROLL RAM C (WORD) | 23 OBJECT RAM (WORD)            |

If ROM(s) is(are) defective, "ROM NG  " will appear on the screen.

When RAM's and ROM's are found all good after completing this RAM and ROM TEST, you can move over to the next test item by pressing the 1P and 2P start buttons.

In case any RAM(s) or ROM(s) is(are) found faulty after completing the RAM and ROM TEST, press the 1P start button to repeat the test. Press the 2P start button to go to the next test.

(4) **Display of the Test Items**

The following test items are shown so that you may select a test item you want by moving the 1P joystick up and down:

1. I/O
2. SOUND
3. CHARACTER
4. COLOR
5. CROSS HATCH
6. OPTION
7. EXIT

Press the Attack button to get the test indicated in red started. Press the 1P and 2P start buttons to end the same test. Press the 1P start button to start "OPTION" test.

(5) **I/O Port Test**

The status when each joystick, button, and coin is turned "ON" is shown.

	8	7	6	5	4	3	2	1	8	7	6	5	4	3	2	1
IN PORT 1	0	0	0	0	0	0	0	0	0	0	0	0	0	0	0	0
IN PORT 2	0	0	0	0	0	0	0	0	0	0	0	0	0	0	0	0
IN PORT 3	0	0	0	0	0	0	0	0	0	0	0	0	0	0	0	0
DIP SW	0	0	0	0	0	0	0	1	0	0	0	0	0	0	0	0

(0-OFF, 1-ON)

(6) **Sound Test**

The screen shows the number of each sound and the test is made about whether the corresponding sound is given. Push down the 1P joystick to move over to the next sound's test.

(7) **Character Test**

The player character is displayed in the center of the screen.

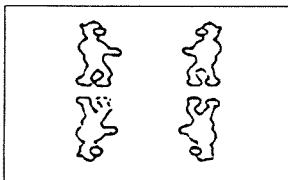

Make sure that the character is shown vertically and horizontally reversed as shown on the left.

(8) **Color Test**

By moving down the 1P joystick, the test can be advanced like  
1 — 2 — 3 — 4 — 5 — 6 — 7 — 8 — 1

- 1 The whole screen shows only blue color.
- 2 The whole screen shows only red color.
- 3 The whole screen shows only magenta color.
- 4 The whole screen shows only green color.
- 5 The whole screen shows only cyan color.
- 6 The whole screen shows only yellow color.
- 7 The whole screen shows only white color.
- 8 A color pattern is displayed as illustrated on the right.

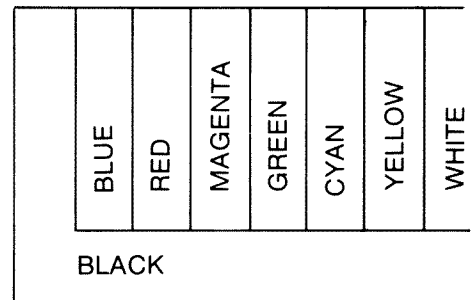

(9) **CROSS HATCH TEST**

The white lines represent CROSS HATCH PATTERN on the screen.

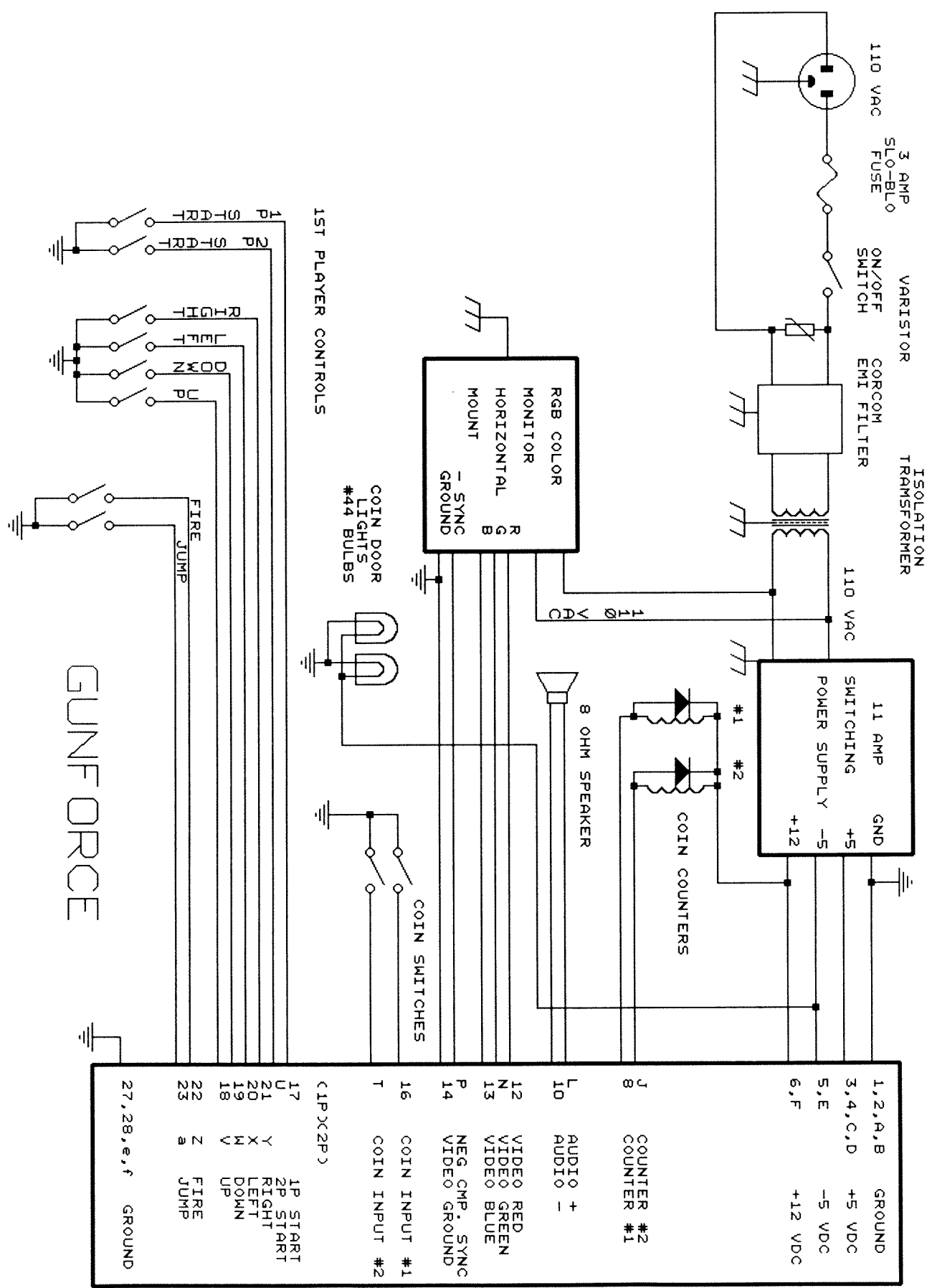

# GUNFORCE

1, 2, A, B	GROUND
3, 4, C, D	+5 VDC
5, E	-5 VDC
6, F	+12 VDC
J	COUNTER #2
8	COUNTER #1
L	AUDIO +
10	AUDIO -
12	VIDEO RED
N	VIDEO GREEN
13	VIDEO BLUE
P	NEG CMP. SYNC
14	VIDEO GROUND
16	COIN INPUT #1
T	COIN INPUT #2
(1P X2P)	
17	1P START
U	2P START
21	RIGHT
20	LEFT
19	DOWN
18	UP
22	Z
23	FIRE JUMP
27, 28, e, f	GROUND

## HOW TO PLAY:

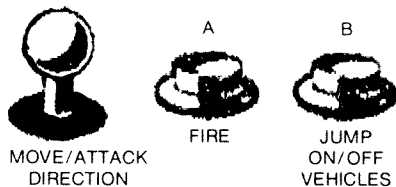

## ITEMS:

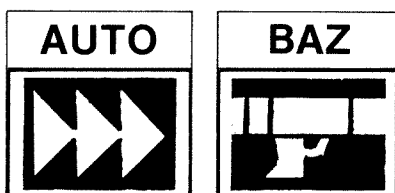

AUTOMATIC  
GUN

BAZOOKA

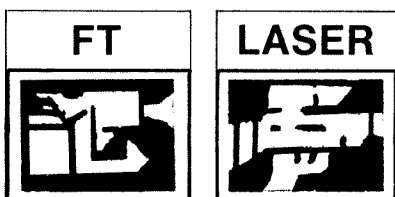

FLAME-  
THROWER

LASERGUN

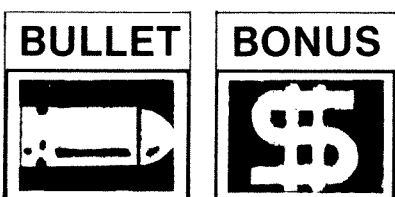

MORE  
ROUNDS

BONUS  
POINTS

## HINTS:

Press "B" button to get on/off vehicles.

You can shoot while hanging on a rope.

Hold joystick down and press "B" button to get off Robo Tank.

## INSTALLATION OF KIT IN NEW CERTIFIED CABINET

We recommend installing this kit in a certified (ARL) cabinet. This cabinet is manufactured to comply with UL22 for safety.