

# THIS IS IT.

## THIS IS THE ULTIMATE TEST.

*THE DARK QUEEN OF KRYNN* is the final battle in SSI's award-winning DRAGONLANCE fantasy role-playing trilogy – and the winner takes all!

## THIS IS YOUR DESTINY.

To fulfill it you must draw upon the skill, wisdom, and courage that brought you to this fateful place. You must also make use of all the resources at your disposal, and *THE DARK QUEEN OF KRYNN CLUE BOOK* is your best and brightest resource.

*THE DARK QUEEN OF KRYNN CLUE BOOK* is much more than a player's guide, it's a powerful ally. And, with the odds against you, your party needs all the help it can get –

❖ **DETAILED MAPS** for the entire game, including locations of all major events in the adventure.

❖ **LISTS** of all major magical items and their locations.

❖ **DESCRIPTIONS** of encounters and treasures – you won't miss any part of the adventure and you'll find all the loot!

*THE DARK QUEEN OF KRYNN CLUE BOOK* – *This is your lucky day.*



▲ *The odds shift strongly in your favor when you carry maps that tell you exactly what to expect around every corner!*

# Advanced Dungeons & Dragons

COMPUTER PRODUCT

## THE DARK QUEEN OF KRYNN

A DRAGONLANCE™ Fantasy Role-Playing Epic, Vol. III

# CLUE BOOK

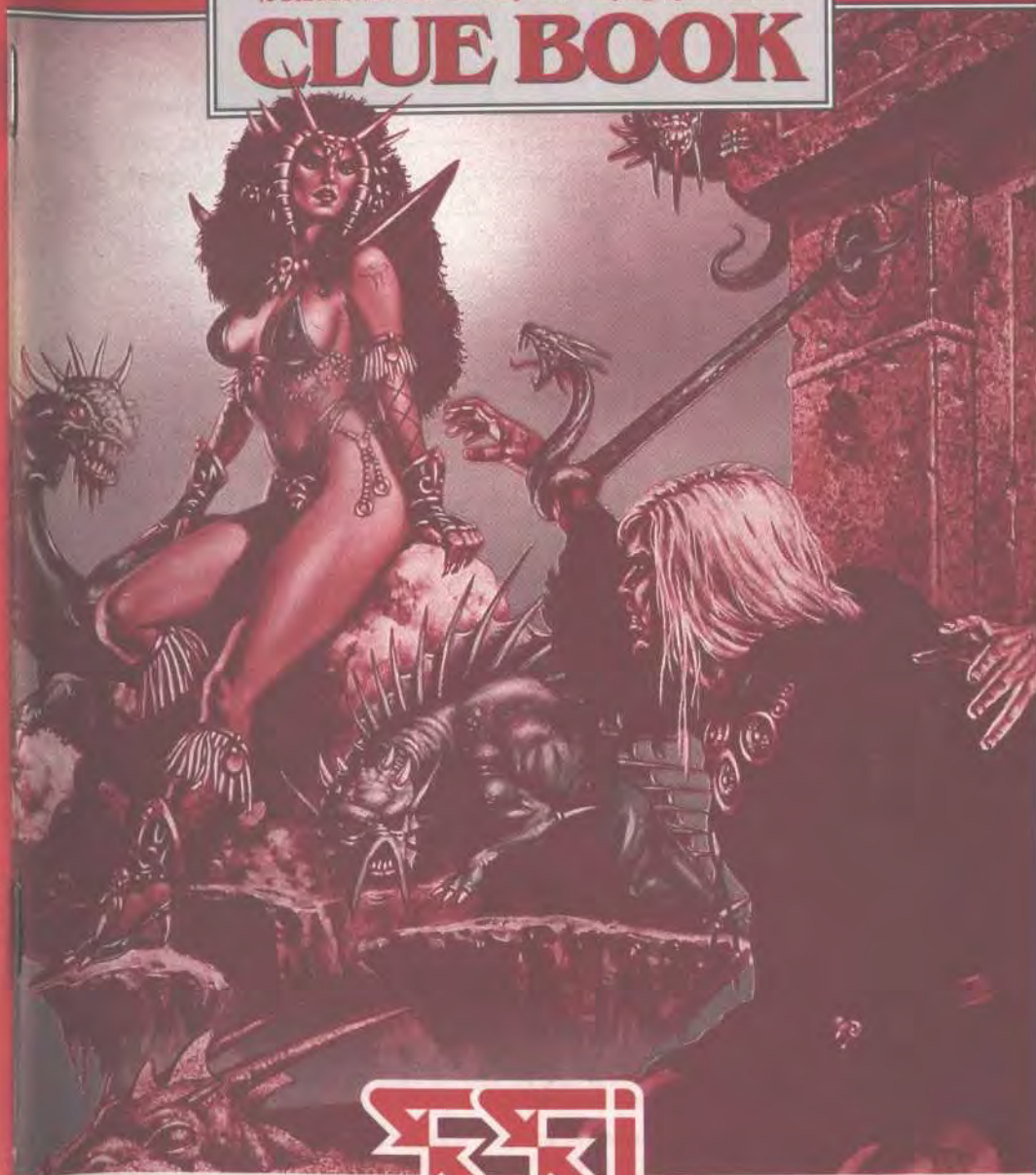

STRATEGIC SIMULATIONS, INC.



ADVANCED DUNGEONS & DRAGONS,  
DRAGONLANCE, and the TSR logo are trademarks  
owned by and used under license from TSR, Inc.  
©1992 Strategic Simulations, Inc.  
©1992 TSR, Inc. All rights reserved.

MADE IN U.S.A.



## TABLE OF CONTENTS

INTRODUCTION .....	1
JOURNAL ENTRIES (TRUE OR FALSE?).....	1
MAJOR MAGICAL ITEMS.....	2
MAPS .....	3
Palanthas .....	3
Caergoth .....	3
Draconian Caves .....	5
Naulidis.....	7
Taladas Overland .....	11
Hamlet of Hizden .....	13
Luminari .....	14
Kristophan .....	19
The Tombs.....	21
Hulderfolk Wood .....	25
New Aurim .....	27
Palace of the Thenol King.....	29
Hawkbluff .....	33
Bai'or .....	37
Blackwater Glade .....	39
Aldinanachru.....	41
Tower of Flame .....	45
The Abyss .....	49
TIPS FOR WINNING BATTLES.....	51
Combat Spells .....	51
Preparation Spells .....	51
Backstabbing .....	52
Underwater Combat .....	52
Dealing with Humanoid Enemies .....	53
Dealing with Monsters .....	53



**STRATEGIC SIMULATIONS, INC.** reserves the right to make improvements in the product described in this clue book at any time and without notice.

Strategic Simulations, Inc. makes no warranties, express or implied, with respect to this clue book, its quality, merchantability or fitness for any particular purpose. This clue book is provided "as is."

ADVANCED DUNGEONS & DRAGONS, AD&D and the TSR logo are trademarks owned by and used under license from TSR, Inc., Lake Geneva, WI USA.

©1992 Strategic Simulations, Inc. ©1992 TSR, Inc. All Rights Reserved.

This clue book is copyrighted and includes proprietary information belonging to TSR, Inc. and Strategic Simulations, Inc. No one is permitted to sell copies of this clue book to any person or institution except as provided for by written agreement with Strategic Simulations, Inc. and TSR, Inc. No one may copy, photocopy, reproduce, translate, or reduce to machine-readable form this clue book without the prior written consent of TSR, Inc.

Any persons reproducing any portion of this clue book for any reason, in any media, shall be guilty of copyright violation and subject to the appropriate civil or criminal action at the discretion of the copyright holder(s).

## INTRODUCTION

THE DARK QUEEN OF KRYNN is Strategic Simulations, Inc.'s sequel to DEATH KNIGHTS OF KRYNN and is the third ADVANCED DUNGEONS & DRAGONS® computer role-playing game set in the DRAGONLANCE™ universe. It takes the award-winning system first used in POOL OF RADIANCE and applies it to the world of Krynn. The group of adventurers you create in THE DARK QUEEN OF KRYNN or transfer from DEATH KNIGHTS OF KRYNN, will be responsible for preventing Takhisis, the Dark Queen, from again entering the material plane and wreaking havoc. Your characters sail to the continent of Taladas, where Takhisis is cultivating a new army. There, your characters form alliances to help destroy these new forces, and they also have to stop the Dark Queen of Krynn.

## JOURNAL ENTRIES (TRUE OR FALSE?)

The following entries in the DARK QUEEN OF KRYNN *Adventurer's Journal* are false:

4, 11, 15, 20, 22, 27, 31, 38, 45, 48, 51, 53, 58, 66

## MAJOR MAGICAL ITEMS

### Draconian Caves

- white mage scroll (*dispel magic, globe of invulnerability, mass charm*)
- shield+3
- flail+4
- necklace of missiles

### Naulidis

- two rings of free action
- staff of striking
- scimitar+3
- wand of paralyzation
- footman's dragonlance

### Luminari

- long sword -3 (*cursed*)
- red mage scroll (*disintegrate, mass invisibility, meteor swarm*)
- white mage scroll (*delayed blast fireball, otto's irresistible dance, power word kill*)
- bracers AC 2
- long sword+4

### Kristophan

- helm+3
- dagger+4
- cloak of displacement
- potion of giant strength

### The Tombs

- cleric scroll (*restoration, resurrection, blade barrier*)
- eyes of petrification (*cursed*) – petrifies the wearer
- girdle of giant strength
- eyes of petrification – petrifies the enemy
- fine long bow

### Hulderfolk Wood

- elfin chain+4
- composite long bow+4
- twenty arrows+4
- potion of speed

### New Aurim

- cleric scroll (*heal, heal, restoration*)
- short sword+4

### Palace of the Thenol King

- plate mail+3
- red mage scroll (*slow, ice storm, iron skin*)
- mace of disruption
- ring of fire resistance

### Hawkbluff

- wand of fireballs
- ten darts+4
- boots of speed
- potion of extra healing

### Bai'or

- ring of fire resistance
- bracers AC 2
- scimitar+4
- scroll of protection vs. dragon breath

### Blackwater Glade

- wand of ice storm
- silver shield+3
- ring of wizardry – doubles 5th level spells
- vorpal long sword

### Aldinanachru

- cloak of protection+3
- hoopak+4
- ring of invisibility
- wand of lightning

### Tower of Flame

- ring of protection+4
- elixir of youth
- 2-handed sword+4

## MAPS

### Palanthalas (no map)

**Synopsis:** The party arrives in Palanthalas after receiving a letter from General Laurana. After speaking with the General in the palace, the party leaves for Caergoth.

**Wandering Monsters:** None.

**Resting:** The party is free to rest at the INN.

**PALACE:** The party meets with General Laurana. If they return with information, then they are told to search for the draconians.

**Other Locations:** The party can hear rumors at the PUB. All other locations provide standard service.

### Caergoth

**Synopsis:** Arriving in Caergoth, the party discovers that disaster has befallen the city. It has been demolished and most of its inhabitants are missing or slain. While searching, they find signs of draconians and dragons. At the harbor, the party encounters Captain Daenor, who lost his sister in the raid on Caergoth. The Captain explains what happened, and volunteers to take the party with him in search of the draconians.

**Wandering Monsters:** None.

**Resting:** The party may rest for only a short while before vultures descend to peck at them.

#### Map Locations:

- 1 The path to and from Palanthalas.
- 2 Shortly after entering Caergoth, dragons discover the party and attack.
- 3 An old woman and child are burying their relatives.
- 4 The body of a slain boy. The party may bury him.

### Caergoth

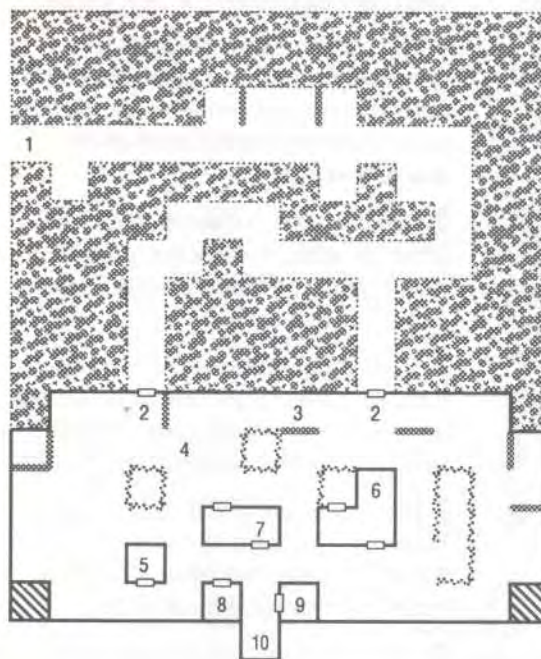

#### Key



Wall



Door



Impassable



Impenetrable Forest



Rubble



Wall of Trees

5 A destroyed home.

6 Vultures feed on the dead.

7 The ruins of a house destroyed by dragons.

8 A vandalized warehouse.

9 The burned out Dockmaster's Office.

10 Sailors leap from the ship to confront the party. Captain Daenor introduces himself and describes the events he has seen. The party should go with him in search of the draconians.

## Draconian Caves

**Synopsis:** Soon after beginning their journey on the "Silver Shark," the characters spot a beached shipwreck. Once on shore, they spot human tracks leading to a cave halfway up a cliff. As the party explores the cave with Captain Daenor, it discovers a horde of draconians camped there. With them are the hostages they kidnapped. The party also finds Crisia, the Captain's sister, who has been charmed and turned against the party. She warns the draconians of the party's presence and escapes deeper into the caves. The characters follow the girl down the winding passages and meet an assortment of cave-dwelling monsters before they catch up with her. They reach the cave's exit just in time to see Crisia mount a small blue dragon and fly toward the horizon. Captain Daenor swears he'll find her even if he has to sail all the way to Taladas.

**Wandering Monsters:** Depending on which part of the cave the party is exploring, it can expect to meet: boring beetles, draconians, otyugh, enormous spiders, whisper spiders and umber hulks.

**Resting:** The party is able to rest freely at the entrance and exit of the cave. If resting elsewhere, the party may be interrupted by wandering monsters.

### Map Locations:

- 1 Captain Daenor and the party enter the cave.
- 2 An elaborate trap blocks the party's way. A thief has a chance to avoid the trap.

- 3 Several draconians are sleeping. The party may leave safely or pick a fight.
- 4 The party encounters Crisia and a group of draconians. Captain Daenor's sister is under a *charm* spell. She escapes down a passage to the north as the draconians attack.
- 5 This is a secret chamber filled with treasure: *white mage scroll (dispel magic, globe of invulnerability, mass charm), shield+3*
- 6 Stone and rubble block the passage. If the characters climb over it they come face to face with a gas spore. Upon striking it, each character takes damage.
- 7 Draconians are guarding prisoners kidnapped in Caergoth. After a fierce battle, the party may move forward to free the prisoners at location 18.
- 8 The party meets Crisia again, this time warning the draconians of the party's arrival. She attacks the party with magic then immediately runs to the west. A character must cast a *dispel magic* spell or the party takes damage from the attack. The draconians attack immediately.
- 9 Piercers fall upon the party, causing damage.
- 10 The party disturbs otyugh in their lair.
- 11 The party battles more otyugh. Searching after combat uncovers old weapons.  
Treasure: *flail+4*
- 12 Boring beetles burst through the wall and attack.
- 13 A purple worm lair.
- 14 The party hears a woman's screams, coming from the south.

## Draconian Caves

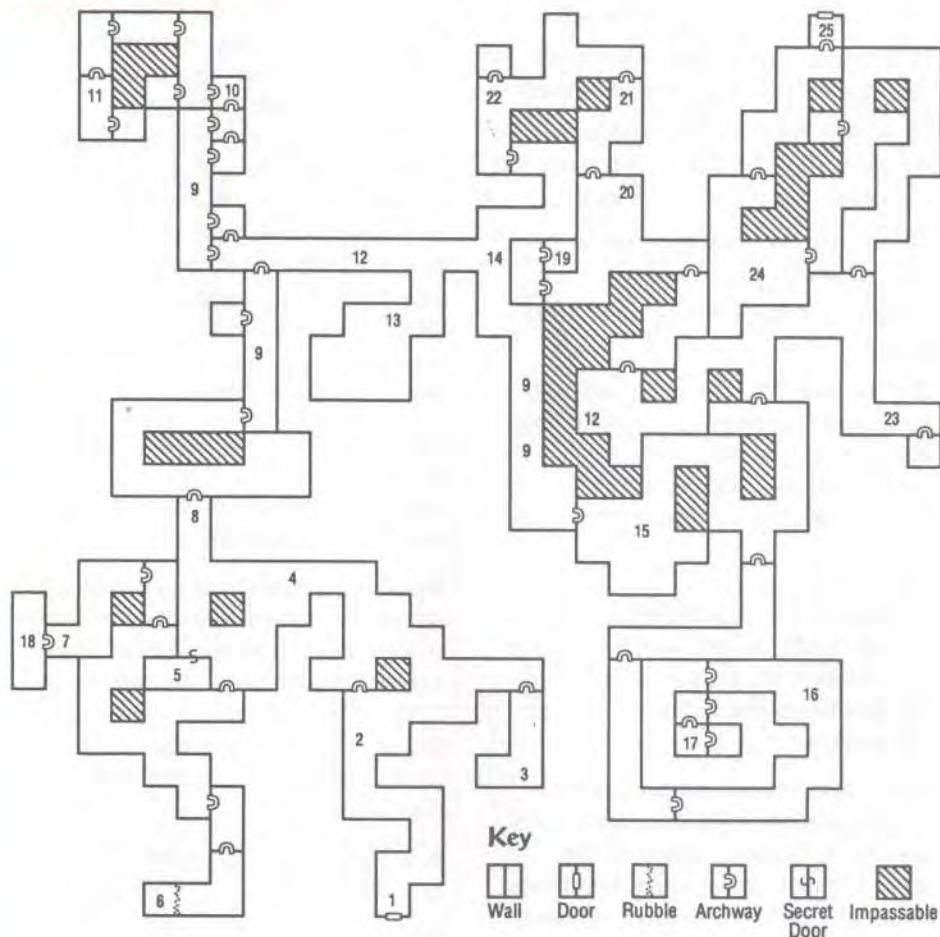

- 15 The beholders here may prove to be difficult opponents to beat.
- 16 Hungry umber hulks attack the party.
- 17 The party meets an old woman, who has escaped from her draconian captors. She recounts her story and rewards the party with a magic item.  
Treasure: *necklace of missiles*

- 18 The party may free the prisoners and then speak with the Mayor of Caergoth, who gives them valuable information.
- 19 An old friend of Captain Daenor lies dying. With his last breath he explains what happened to Crisia.

"Draconian Caves" continues...

**20** Whisper spiders and enormous spiders attack the party in this cell.

**21** A draconian has fallen victim to spiders. Searching reveals a piece of jewelry.

**22** Spiders have created a decoy to fool the party. Once the trap is destroyed, the party is ambushed from the east.

**23** Another lair of otyugh, and shambling mounds.

**24** Blue and black dragons attack the party.

**25** The cave exit. The party arrives in time to see Crysia escaping on the back of a blue dragon. The party now has the choice of exiting, which leads back to the "Silver Shark," or entering the cave again.

## Naulidis

**Synopsis:** The characters are saved from drowning by the Dargonesti elves of Naulidis. They are put under enchantments that allow them to live underwater.

Movement and combat are hindered underwater, however, and many spells don't work or have altered effects. While the party is becoming acclimated to underwater life, sea dragons attack, and the characters are called upon to assist in the city's evacuation and defense. They then rescue Captain Daenor, incapacitated in the shipwreck. He tells them he has learned that the treacherous sahuagin are holding sea dragon eggs hostage and forcing the monsters to attack the sea elves. Since the eggs are being held in an air pocket in the nearby ruins of Celanost, the party is assigned to recover them.

The party traverses a long undersea tunnel that leads to the Celanost ruin, and rescues the eggs from the mercenary mages and the fiery creatures that guard them. When the eggs are returned to the sea dragons, the dragons agree to unite against the sahuagin, and the conspiracy is undone. The party helps find the sahuagin leader, Prince Talhook, as he attempts one last perfidious act: the assassination of Prince Lyzian of Naulidis. Afterwards, the sea elves take the party the rest of the way to the continent of Taladas.

**Note:** The party must be careful to use the CRYLOKON only at the air bubble. It only works twice. If they use it elsewhere they may drown.

**Wandering Monsters:** Until the eggs are returned to the sea dragons, these powerful creatures prowl all of Naulidis except the safe halls. The corridor to Celanost and the ruined city itself are full of various ocean predators. The air pocket contains wandering bands of fire creatures.

**Resting:** Rest is most secure in the safe halls.

### Map Locations:

**1** A locked room where the party awakens. The sea elf prince, Lyzian, gives them a ring which negates the movement and combat effects of being underwater.

**Treasure:** *ring of free action*

**2** Safe halls. Players receive a variety of missions from defenders here and from elves in need all over the city. If the characters heal wounded elves, they

## Naulidis

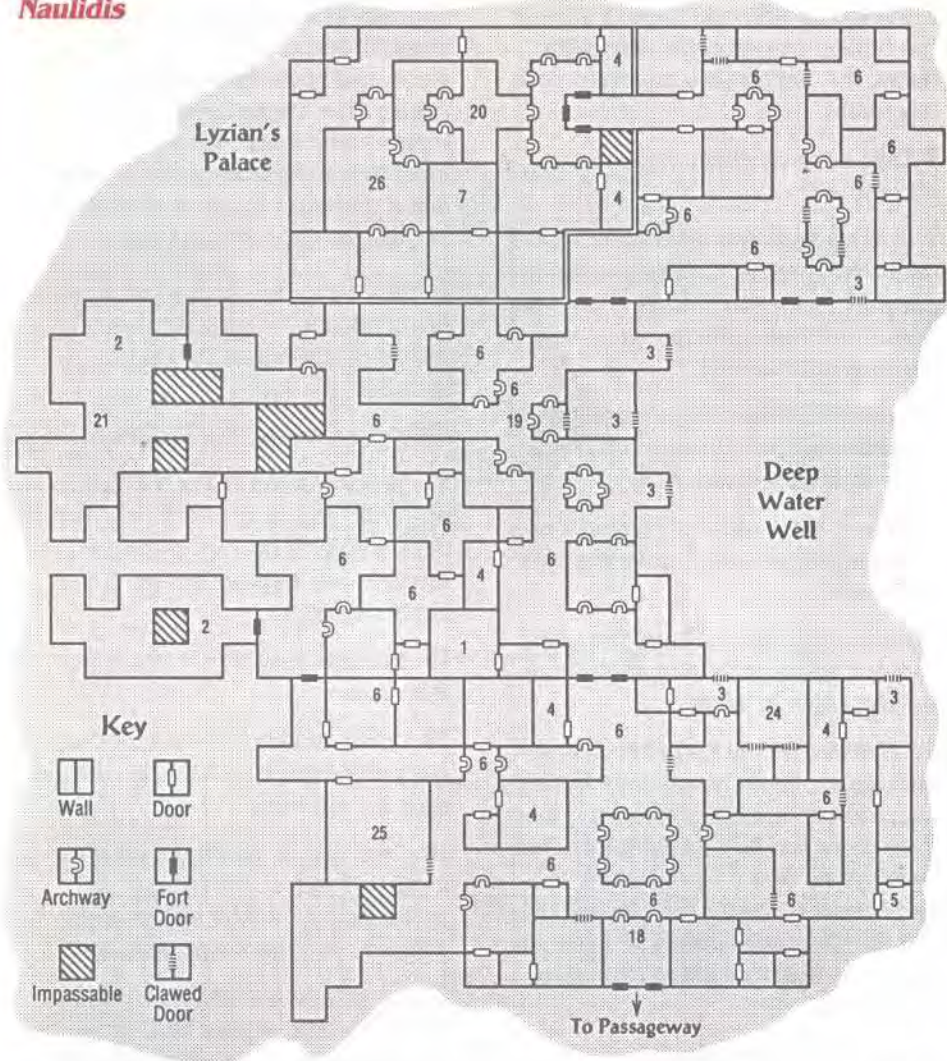

may be rewarded with a magic staff or scimitar. The characters also receive a second magic ring and a map of the city when they agree to fetch a new hinge for a damaged door or rescue Daenor.

**Treasure:** *ring of free action, staff of striking, scimitar+3*

**3** Defense rallying points. Elves attempt to hold these doors against the dragons outside.

**4** Guardrooms. Irenia, a young sea elf, is hiding in one of these.

"Naulidis" continues...

**5** Workroom with cold forge. If a hinge has broken on one of the safe hall's doors, the party finds a replacement in this room.

**6** The party may encounter elves in distress.

**7** Lyzian's Bedroom. After Lyzian tells the party to rescue Captain Daenor, the party finds him here, hiding behind the door. Once found, Daenor must be returned to location 2.

After the sea dragon eggs have been liberated, the party flushes out Prince Talhook waiting in ambush.

**8** Tunnel. Many wild sea creatures may be found in the tunnel, including eyes of the deep.

**9** Gates into Celanost Ruin. The party may see sahuagin hauling air down to the air pocket in sleds.

**10** Well into the Air Pocket Rooms at location 11. These rooms were formerly used to entertain friends from the land. If the characters do not have a CRYLOKON from Lyzian, they cannot breathe air, and cannot survive in the pocket. They use the CRYLOKON to first lift and then recast the water-breathing spell upon themselves.

**11** Well back to location 10.

**12** Fire creatures wait in ambush at these doors. Taking the passage at location 22 and attacking the monsters from behind foils their ambush.

**13** Chambers of the rogue mages of Malgi Hi. Searching reveals gems, a wand, and notes that explain the conspiracy. The mages have fled to the rooms to the south. The characters must defeat these mages at location 23 first if they want to get all of the items.

Treasure: *wand of paralyzation*

**14** This large room is guarded by more fire creatures. Entering the room through the windows foils their ambush.

**15** Well containing the sea dragon eggs.

**16** Sea dragons confront the characters. They may only pass if they surrender the eggs. If they fight with the dragons, any eggs are stolen by the crafty sahuagin.

**17** Sahuagin may hide stolen eggs in this room.

**18** Lyzian and his train wait for the party at the gates until the sea dragon eggs are recovered.

**19** Elven guards escort the party to location 7 to rest. This triggers an assassination attempt by Prince Talhook, who has magic weapons.

**20** A sahuagin ambush waits here for the characters, as they head to Prince Lyzian's bedroom to rescue Captain Daenor.

*"Nauldis" continues...*

## Celanost Ruin

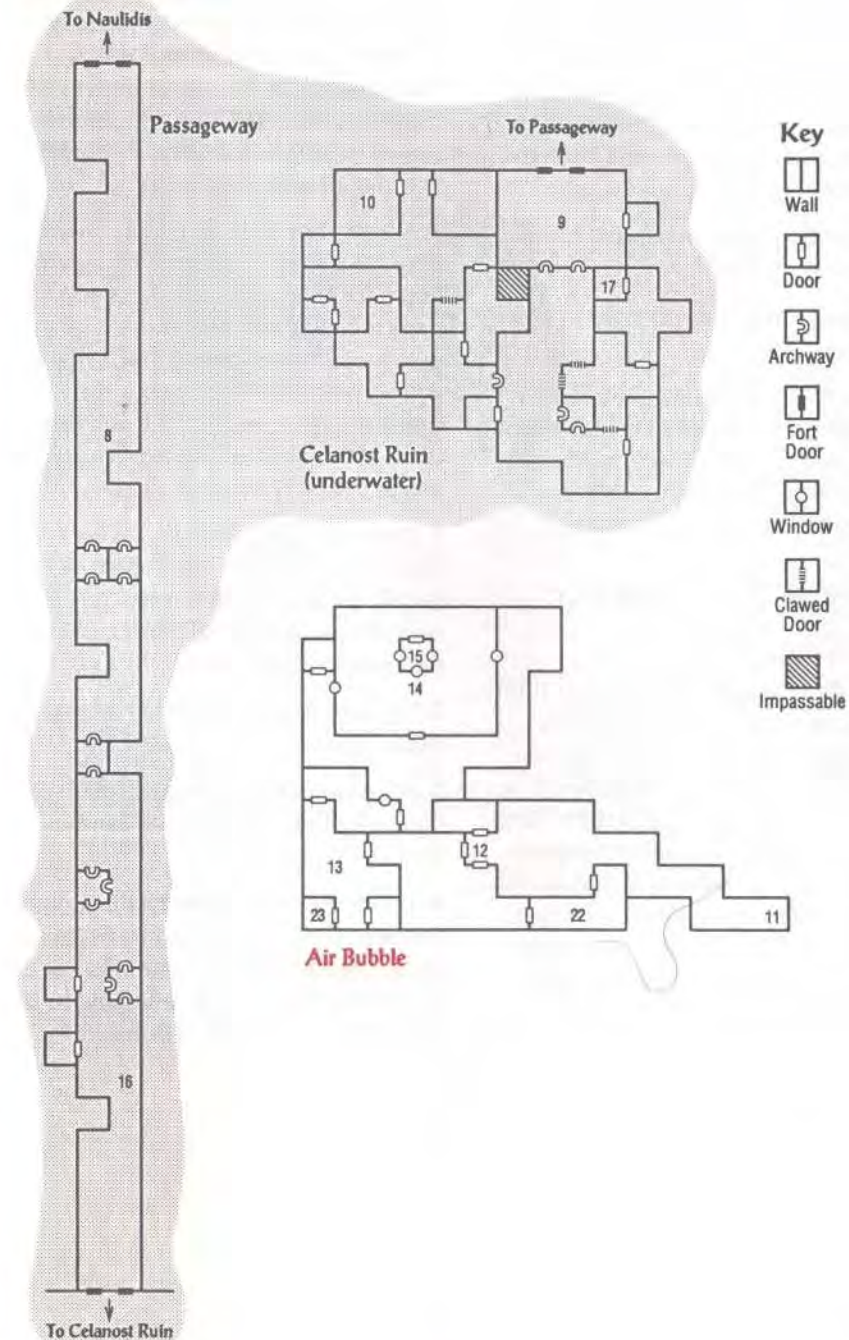

**21** Sea elf training hall.

**22** Side Passageway. If the party takes this path, it breaks the ambush at location 12.

**23** A mage is summoning monsters in his room. He and his minions immediately attack.

**24** A common room being torn up by dragons.

**25** A temple also being torn up by dragons.

**26** After Prince Talhook is defeated, Lyzian meets the party for celebration. He awards it a *dragonlance*, a gift from the Dargonesti Kings. Afterward, the elves take the party undersea to Taladas.

Treasure: *footman's dragonlance*

### Taladas Overland

The overland map is used to travel from place to place on Taladas. This map shows the area covered in the game and shows many of the major points of interest as symbols on the terrain. Many monsters may be encountered during overland travel, providing opportunities for characters to gain additional experience levels. There are also numerous caravans of merchants, pilgrims, and the like, who may provide valuable ser-

vices to the party. The party's location and its terrain affect the kinds of encounters the party has. Different kinds of monsters inhabit different locales. Camping is possible almost anywhere outside Armach territory, but there is always a risk that monsters or patrols may disturb the party's rest.

The party may acquire THENOL ARMY UNIFORMS from some slain opponents in the southern areas of the map. The party automatically puts these on if they take them. The uniforms make Thenol patrols much friendlier to the party. On the other hand, wearing the uniforms in the north causes minotaur bands to attack the party more frequently.

**1** These are generic towns. At each town there is a TEMPLE, a TRAINING HALL, an INN, a PUB, where the party can gather information, and a SHOP, which sells non-magical equipment.

**2** There is no way the party can reach these places.

**3** After the party has thwarted the Dark Queen's plans, these straits can be forded.

**4** This is the edge of the Elf-Kingdom of Armach. If the party ventures beyond these borders, it is showered with arrows by hidden elves. There is nothing to be gained by trespassing in Armach.

### Taladas Overland

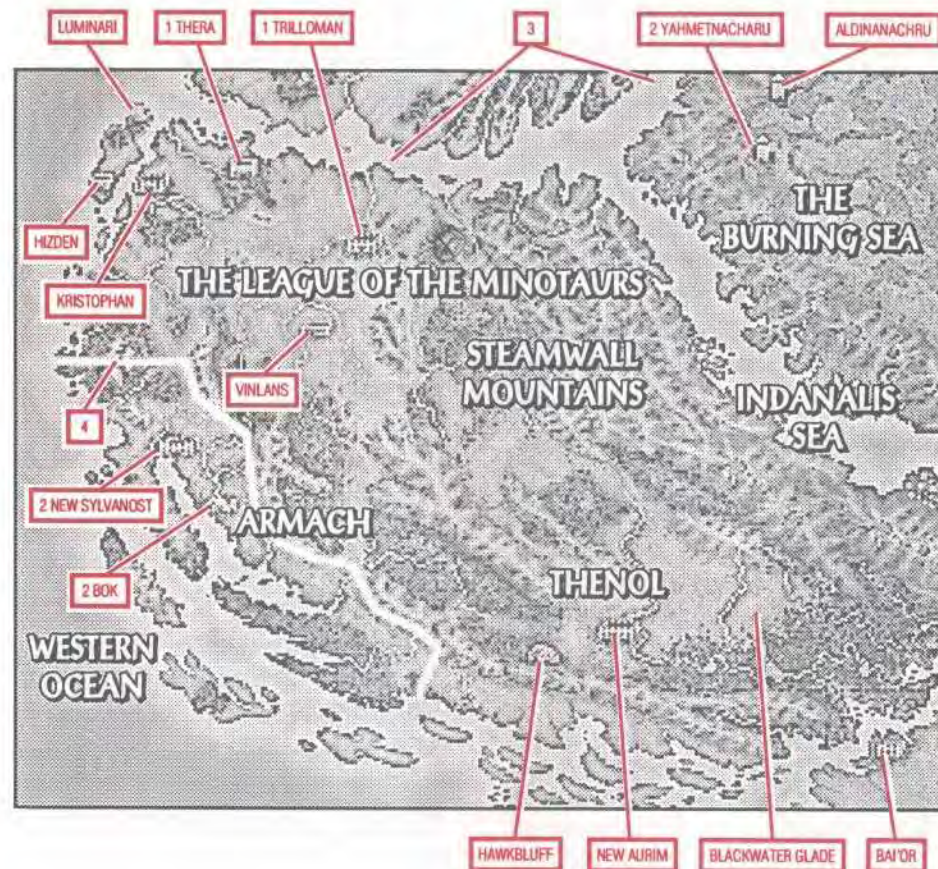



## Hamlet of Hizden

**Synopsis:** The party awakens in a quiet inn, late in the evening. The Hamlet of Hizden is a small town on Taladas populated by the "Children of the Sea," the offspring of sea elves and men. When the party speaks to Ezra, as Lyzian has suggested, the party is told about the Luminari lighthouse and the wizard who can help them. Before the party can resume its quest, sahuagin who have followed the party, attack!

**Wandering Monsters:** The sahuagin attack comes shortly after leaving Ezra.

**Resting:** The party may rest freely at the inn and the abandoned building.

### Map Locations:

- 1 The Inn.
- 2 A Training Hall.
- 3 General Store.
- 4 Tavern.
- 5 Ezra's Bait Shop.
- 6 Town gate.
- 7 Thieves' hangout.
- 8 Fish Market.
- 9 Townsfolk repel the party from their home.

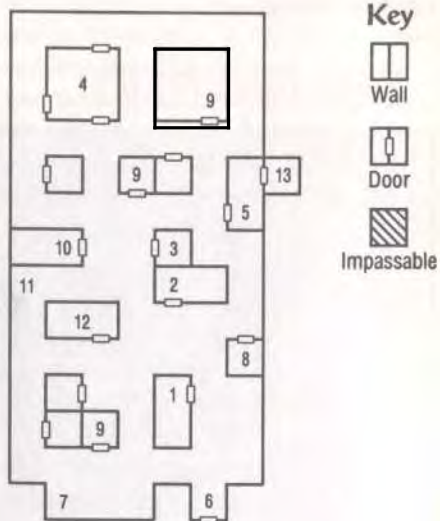

- 10 Mislaxa Temple. Healing services are available here.
- 11 Mislaxa priest looking for donations. The priest heals any non-elf that gives him a donation.
- 12 Abandoned building where the party may rest.
- 13 Ezra is mending nets. If the party gives the CRYLOKON to him, the party is given valuable information.

## Luminari Lower Reaches

### 2nd Deep

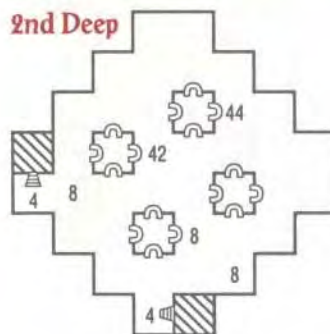

### 1st Deep

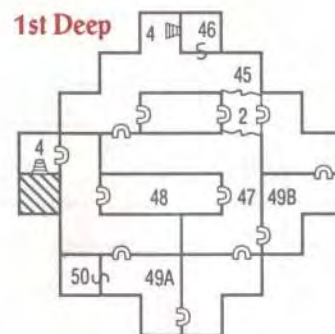

## Luminari

**Synopsis:** In the Luminari lighthouse, the characters seek to reach the wizard Fastillion, who gives them wise counsel, as well as two keys to the inner chambers of the tombs. Alas, Fastillion is quite mad, and has filled his tower with traps, obstacles, and deadly perils to keep unwanted visitors out of (what's left of) his hair. To make matters worse, he has forgotten all about these defenses decades ago, and the whole place has decayed into ever-greater chaos and confusion.

The party may make their way up through the tower, gaining experience, treasure and magical items along the way, but the route to Fastillion is ultimately by way of location 50 on the 1st Deep.

The strange and powerful vortex of energy on level 5 is a turning-point in the party's ascent of the lighthouse. After this level, it is not entirely safe to rest, because of umber hulks roaming the tower. Also, the battles are tougher in the upper reaches, and the teleporters are trickier. Finally, on level 11, the party is stopped by a door they cannot open. Returning to level 10, they encounter a woman of the Hulderfolk. She has been crushed by a gorgon that she somehow turned to stone. Before she dies, she gives the party a clue to the location of the teleporter that leads to Fastillion.

*"Luminari" continues...*

## Luminari Lower Reaches (continued)

Level 1



Level 2

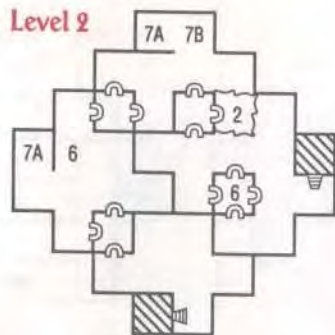

Level 3



Level 4

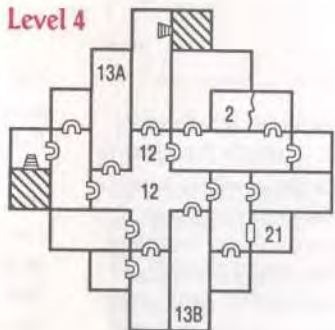

### Key



Wall



Door



Archway

One Way  
DoorStairs  
UpStairs  
DownThe  
Pit

Impassable

**Wandering Monsters:** Huge bats and enormous spiders inhabit this part of the tower, but they learn to leave the party alone after the first few encounters. Boring beetles attack in the 2nd Deep. The vortex keeps the bats and spiders out of the upper reaches, but umber hulks roam this part of the tower (except for the top level).

**Resting:** Anywhere in the lower reaches of the tower except the 2nd Deep is safe to rest after the bats and spiders have been scared off. In the upper reaches, the party may rest safely in the "eye" of the vortex, Fastillion's closet, and the teleporter control room.

### Map Locations:

- The stone porch of the lighthouse. This is the only entrance to the lighthouse.
- A poorly-concealed pit, which passes through the floors of each level, down to the 2nd Deep. Falling into this pit causes some damage and leaves the party in the 2nd Deep.
- The ettin dangling in an enormous web is bait left by whisper spiders to attract prey. If the ettin is freed, it helps the spiders attack the party.
- A destroyed staircase.
- A destroyed teleporter archway.

## Luminari Upper Reaches

Level 5

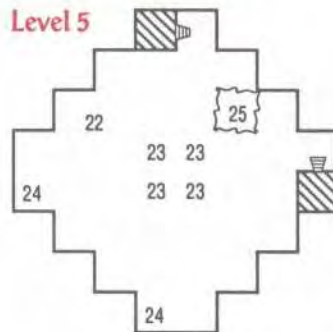

Level 6

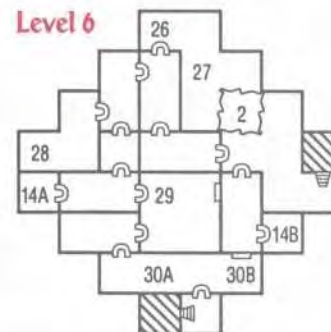

Level 7

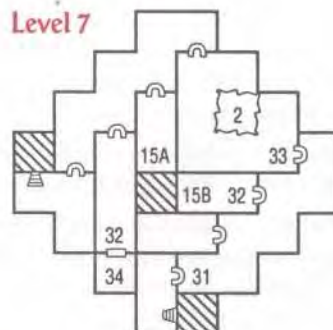

Level 8

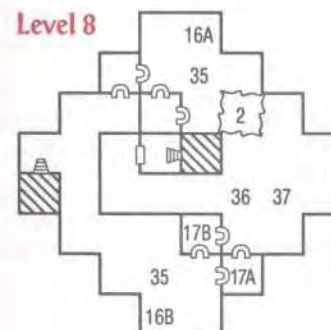

**6** Ettins and two-headed trolls attack the party.

**7a** A false stair that secretly teleports the party to 7b.

**8** The party finds a small mound of treasure.

**9** A storeroom full of old building materials.

**10** The party finds a strange contraption in this room.

**11** There is a gnome blocking the stairs with an invisible barrier. The party needs to get the strange contraption at location 10 and offer it to the gnome.

**12** The party must give the spectral guardians a gem to pass either of these locations if it hopes to avoid a fight. If the spectral guardians are destroyed, some of their equipment falls to the ground.

Treasure: long sword -3 (cursed)

**13a - 20a** Secret teleporters that move the characters to the b location, and turn them to make the walls look similar.

**21** A locked room containing a "To Do" list that Fastillion lost decades ago.

"Luminari" continues...

## Luminari Upper Reaches (continued)

## Level 9

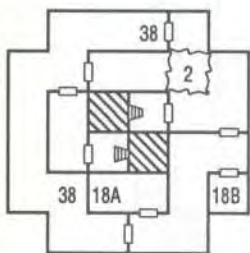

## Level 10

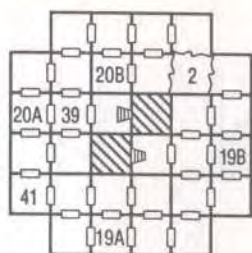

## Level 11

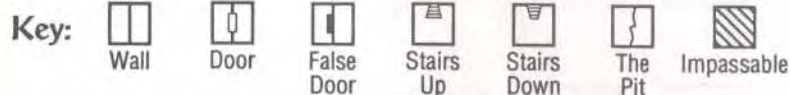
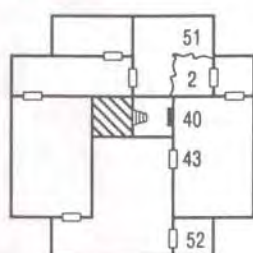

**22** This area is filled with an incomprehensible energy vortex that dulls the party's senses and causes minor damage to the party every turn.

**23** The "eye" of the vortex. A safe place to rest.

**24** Heaps of jewels and gems are piled in these corners of the room.

**25** The pit that passes through the vortex.

**26** The party overhears a group of dark wizards planning an attack on Fastillion.

**27** A group of dark mages are plotting against Fastillion in this room.

**28** An umber hulk lair.

**29** A beholder and an umber hulk flee from the party.

**30a** A secret teleporter that moves the party past the stair to 30b at the one-way door.

**31** The steel jaw trap looks scary, but it's broken. The party shouldn't bother trying to disarm it.

**32** Beholders in their lairs.

**33** A battle between two beholder groups. When they see the party, they attack.

**34** A locked room containing a heavy stone lever that controls the teleporters (except for the teleporter archways.) The party can leave the lever in the on position in order to use the teleporter at location 37 to rest in the "eye" of the vortex, or it can turn the teleporters off, to simplify navigation.

**35** The party is ambushed by fire elementals.

**36** Fire elementals guarding a chest.  
Treasure: *red mage scroll (disintegrate, mass invisibility, meteor swarm)*, *white mage scroll (delayed blast fireball, otto's irresistible dance, power word kill)*

**37** A teleporter that sends the party to location 23.

**38** Beholders and gorgons assault the party.

**39** Iron golems guard the door.

**40** This door has been shut with powerful magic and stonework. The party cannot open it.

**41** After attempting the false door on Level 11, the characters meet a Hulder woman pinned under a stone gorgon. If they move the gorgon, she gives them a clue to the location of the teleporter at location 50 and bequeaths them her bracers and staff. (The fastest way down to location 50 is to jump into the pit at location 2.)

Treasure: *bracers AC 2, long sword+4*

**42** A large expanse of filth and decay, inhabited by purple worms, otyugh, and boring beetles. If the party falls into this level, the filth cushions its fall, but the inhabitants attack with surprise. The purple worms and otyugh can be eliminated, but the beetles always come back.

**43** Fastillion counsels the party to seek the ORACLE OF TENQUR in the tombs on the edge of the old city of Kristophan; and he gives them two keys to the inner chambers of the tombs: the GOLDEN KEY and the RUSTED KEY. The party also has this encounter with Fastillion if they attempt to rest anywhere on Level 11 (except location 52).

**44** After defeating the monsters, the party may climb atop this mound and escape up through the pit to location 45.

**45** Climbing up from location 44 brings the party here.

**46** A teleporter archway to location 5.

**47** Hydras block the passage at this spot.

**48** A secret teleporter that turns the party around. If the teleporters are on, the party should step into this location and then turn around. When the party steps forward, it moves in its original direction.

**49a** A secret teleporter to location 49b that turns the party to make the walls look the same.

**50** A teleporter archway to location 51 on Level 11.

**51** A teleporter archway to location 50 in the 1st Deep.

**52** A large unused closet. This is a good place to rest.

## Kristophan

**Synopsis:** Kristophan is the Capitol of the League, a large city filled with humans and minotaurs, who are clearly the ruling class. The party must be careful not to aggravate the arrogant minotaurs, since no good can come of this. While here, the party hears about the disappearance of the *BOOK OF AMROCAR*. Later the book can be recovered in Hawkbluff, and is needed to complete the game. Selias, a thief, is found in a pub minutes before marauding evil dragons attack the town. He leads the party to the tombs, where they can take shelter.

**Wandering Monsters:** Thieves may be encountered in the east end of town. They quickly learn not to fool with the party and avoid them. Minotaurs may pick a fight with the party in the Imperial City, to the west.

**Resting:** The party can only rest safely in inns or in the homes of strangers if they are invited.

### Map Locations:

**1** The party's arrival at the city is interrupted by the sound of weeping. They arrive before a small house. The party can then continue into the house, enter the city, or return to the overland.

**2** The party meets Eshalla the hag. The party should ask her what's wrong, listen to her story, and then comfort her. This entails kissing her until her curse is broken. Once she has been successfully restored, she rewards the party with a cloak. Eshalla later looks for the hero who helped her in the east end of town. The first time she finds him she gives him a helm, the second time a dagger.

Treasure: *helm*+3, *dagger*+4, *cloak of displacement*

**3** The Gates of Kristophan. The party enters here.

**4** A group of humans is startled to see the party. Unless the party leaves immediately, guards attack.

**5** Cows House of Fashions. Guards attack if the party refuses to leave.

**6** Hooves Polished. Guards attack if the party refuses to leave this shop.

**7** The occupants of this house invite the party to stay for tea. The party hears important rumors; most notably, that the *BOOK OF AMROCAR* has been stolen from the library. Eventually, a mishap befalls the family and they no longer give the party rumors.

**8** The City Vault. Items and money can be stored here.

**9** An empty house.

**10** The Watering Trough. A beautiful minotaur pub with very unfriendly customers.

**11** The Bullish Gourmet. Guards attack if the party refuses to leave.

**12** Shackles by Shariskis. Guards attack if the party refuses to leave.

**13** Imperial Training Hall of the Champions Guild. The characters can train if they lie and say that they are training for the Champions Guild.

**14** Imperial Arena of Kristophan. The arena is only open when the party is the featured combatant.

**15** The Golden Stables. A very high priced minotaur inn. There are cheaper alternatives, but it may come in handy.

**16** A safe room to rest.

**17** Due to rioting the road is blocked and heavily guarded.

## Kristophan

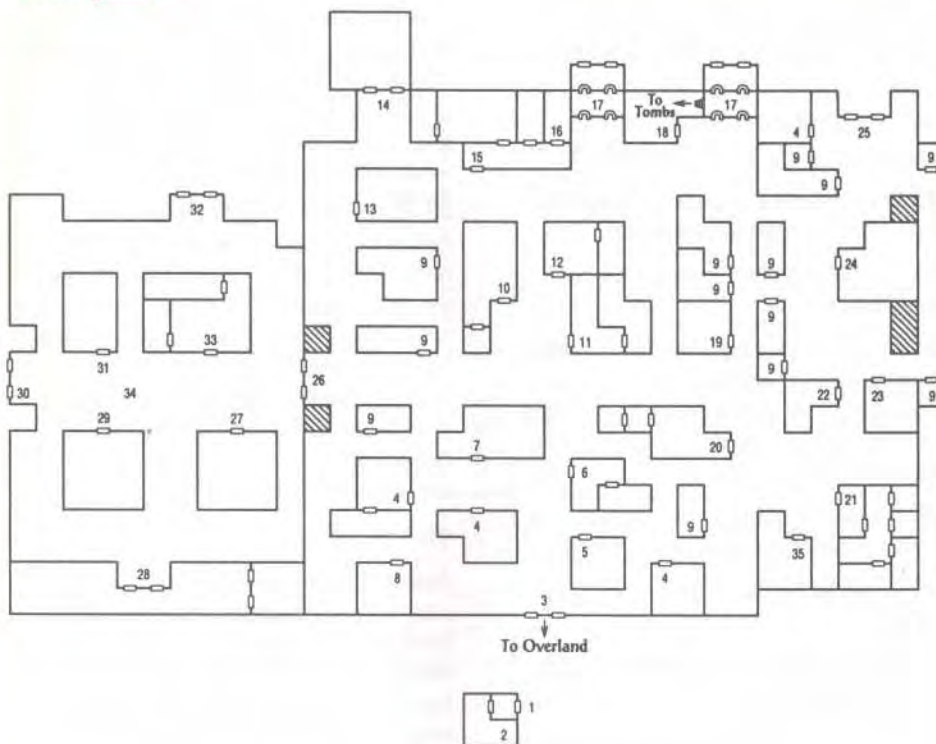

Key: Wall Door Archway Impassable Stairs Down

**18** An old temple that leads to the tombs. It is only accessible if Selias is with the party.

**19** A kind, old woman allows the party to rest in her house for as long as it wants.

**20** The Peoples' Temple. The characters can be healed, free of charge. If they agree that they are faithful to Mislaxa, the temple cleric offers to sell them magic scrolls.

**21** Tenderloin Lodge. A cheap and safe place to rest.

**22** The party interrupts a group of thieves dividing their loot. After the characters defeat them, they can claim the thieves' treasure.

Treasure: *potion of giant strength*

*"Kristophan" continues...*

**23** The Oracle of Tengur. A charlatan fortune teller tells the party about the real Oracle and gives them a bad divination.

**24** Peoples' General Store. The party can stock up on basic items in this shop.

**25** The original entrance to the tombs, now blocked and impassable.

**26** Entrance to the Imperial City of Kristophan.

**27** Villa of Arishanolis III. The characters cannot enter. If they attempt to fight their way in, they eventually have to flee from the scores of guards who defend the Villa.

**28** Hordes of guards leaving their barracks prevent the party from entering.

**29** Imperial Senate. The party cannot enter.

**30** Palace of King Ambeoutin XI. The party cannot enter.

**31** Official Ministries of Kristophan. The party cannot enter.

**32** The Queen's Palace. The characters cannot enter. If they attempt to fight their way in, they eventually have to flee from the scores of guards defending the palace.

**33** Imperial Library. The party may enter and inquire about books. When asked the name of the author of the book they wish to read, they should say **AMROCAR**. The party learns that the book was stolen under mysterious conditions and has not been recovered.

**34** The party encounters an old minotaur abusing a human slave. If the party attacks the minotaur, they are quickly

overpowered. After the party awakens in a jail cell, they are escorted to the arena to pay for their indiscretion. The characters have to defeat powerful champion minotaurs, but are able to claim the minotaurs' magical armor and weapons if they win.

**35** The Frosty Mug. The party meets Selias in this cozy bar. He explains that he is a thief by trade and that he is willing to bring the party to the tombs for a price. The conversation is interrupted by a dragonstrike. Selias joins the party and tells them to go to the old temple at location 18. If the party makes it, Selias opens the magic door and leads the party into the tombs.

### The Tombs

**Synopsis:** The tombs are a sprawling labyrinth of passages and chambers linked together by a series of unpredictable teleporters. The party encounters thieves, monsters, and undead in their quest for the ORACLE OF TENGUR. The Oracle is a tiny statue that has been broken into five pieces. Each piece gives the party a new clue or bit of advice. Eventually, it becomes clear that the pieces of the ORACLE OF TENGUR have been scattered about in an attempt to lure unsuspecting adventurers deep into a lair of vampires.

**Wandering Monsters:** The party may encounter whisper spiders, enormous spiders, and umber hulks anywhere in the tombs. Purple worms may be encountered in the first level. Undead inhabit the catacombs.

**Resting:** Resting is only safe in the main hall, which has a blocked entrance at the east end and a large statue of the Oracle at the west end.

### The Tombs

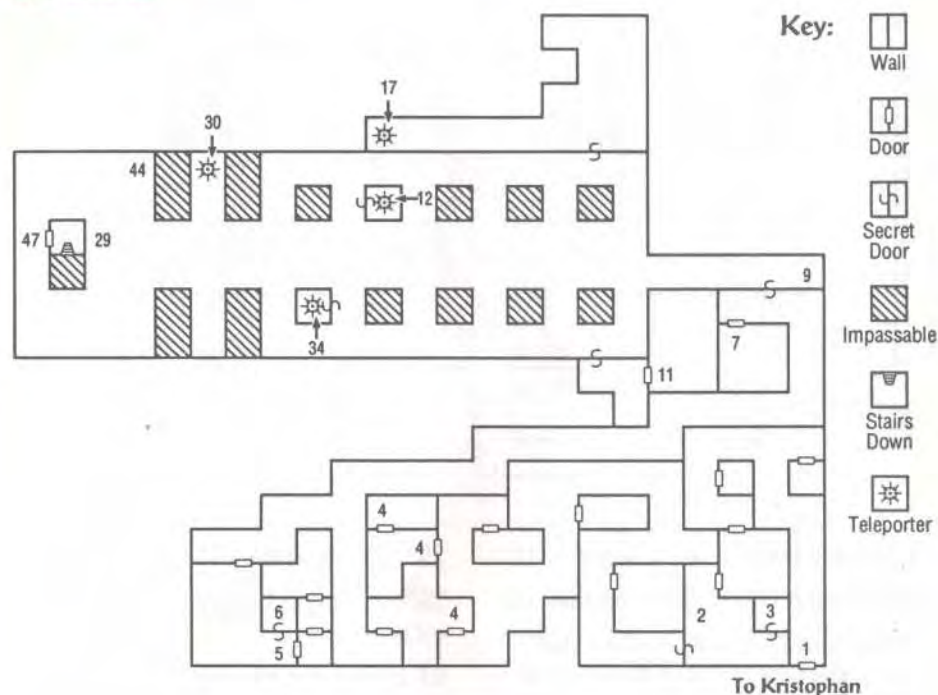

#### Map Locations:

**1** The entrance to the tombs.

**2** The party surprises a group of thieves. They attack once they recognize Selias as an ex-member who stole from them.

**3** The thieves' stash is stored here.

**4** Greater otyugh and shambling mounds reside in these rooms.

**5** A lair of black puddings.

**6** The party finds a scroll.

Treasure: cleric scroll (restoration, resurrection, blade barrier).

**7** An abandoned Cleric Purification Chamber.

**8** These teleporters lead to location 29.

**9** The original entrance to the tombs, now blocked.

**10** The party is teleported to this spot from location 54. There is a spiked trap here, like location 56.

**11** Evil mages are worshipping at an altar to Hiddukel. After dispatching them the party can steal the statue's eyes.

Treasure: eyes of petrification (cursed) — petrifies the wearer

"The Tombs" continues...

### The Tombs (continued)

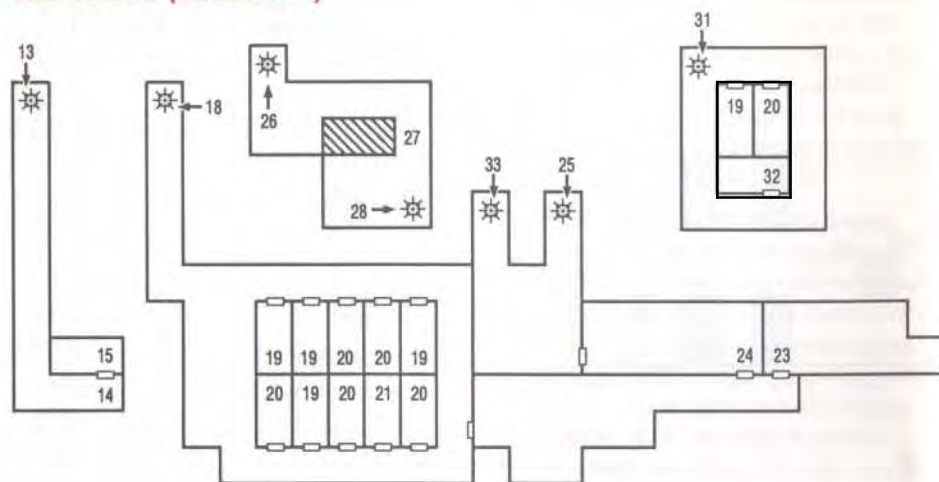

**12** This teleporter leads to location 13.

**13** This teleporter leads to location 12.

**14** The door is actually a mimic that attacks the first character that tries to pick or bash it.

**15** The party is attacked by a group of vampires and death dragons.

**16** Hydras attack the party.

**17** This teleporter leads to location 18.

**18** This teleporter leads to location 17.

**19** Treasure chests.

**20** These treasure chests are mimics that attack the first character that tries to open them.

**21** This treasure chest contains the **HEART SHAPED KEY**, which is needed at location 32.

**22** This chest can be opened with the **RUSTED KEY**.

Treasure: *girdle of giant strength*

**23** Another black pudding lair.

**24** The purple worm lair.

**25** This teleporter leads to location 26.

**26** The party is teleported here from location 25.

**27** Eshkal, the city tax collector, insists that the party pay one quarter of all its steel. Paying the fee allows the party to proceed to the teleporter at location 28. Refusing to pay leads to a battle with spectres, wraiths, and death dragons.

**28** This teleporter leads to location 29.

**29** There is a statue commemorating the Oracle of Tengur. This is not the Oracle the party seeks, and **TALK** and **RUB STATUE** do nothing.

**30** This teleporter leads to location 31.

**31** This teleporter leads to location 30.

**32** The party meets a spectral guardian, who is seeking the **HEART SHAPED KEY**. If the party lies to him or refuses to give him the key, the party has to face him and his cohorts. Once the party gives him the key it recovered at location 21, the party is rewarded with another piece of the **ORACLE OF TENGUR**.

### The Tombs (continued)

Key:

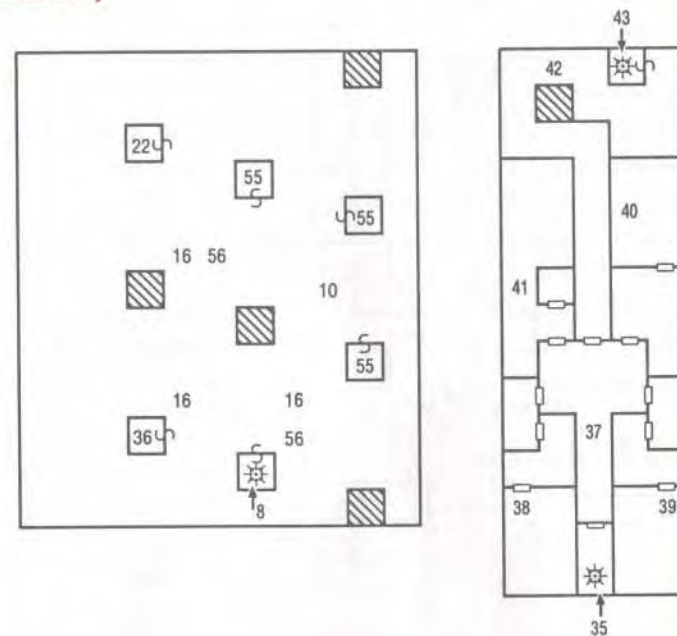

**33** This teleporter leads to location 29.

**34** This teleporter leads to location 35.

**35** The party is teleported here from location 34.

**36** The party finds magical eyes.

Treasure: *eyes of petrification* — petrifies the enemy

**37** The party is welcomed to Lord Destries' Side Show. Admittance is one quarter of all the party's steel. Refusal to pay leads to a battle with undead.

**38** Lord Destries' "Trained Animals." The umber hulks attack.

**39** Lord Destries holds two-headed trolls in this room. They attack the party.

**40** Lord Destries' hydras charge the party.

**41** Lord Destries' "Tightrope Walkers." Spiders assail the party. After combat,

searching reveals another piece of the **ORACLE OF TENGUR**.

**42** Lord Destries' "Special Attraction" of death dragons, wraiths, and spectres. After combat, searching reveals the **CIRCLET OF GOLD**, which is needed at location 46.

**43** This teleporter leads to location 29. Before the party can leave, the party must defeat Lord Destries and the last of his followers.

**44** This trap door leads to location 45.

**45** This ladder leads to location 44.

**46** The characters meet a ghostly figure, who begs them to return the **CIRCLET OF GOLD**. Lying or refusing to give him the circlet leads to combat.

"The Tombs" continues...

## The Tombs (continued)

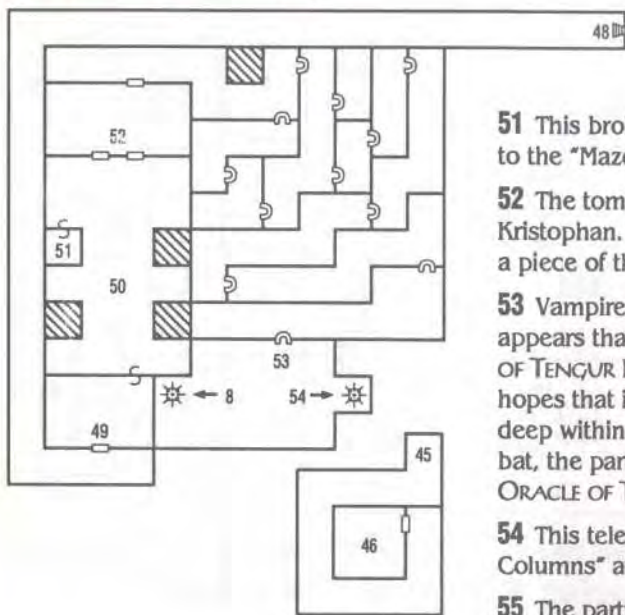

**51** This broken teleporter used to lead to the "Maze of Columns."

**52** The tomb of the ancient King of Kristophan. If searched, the party finds a piece of the ORACLE OF TENÇUR.

**53** Vampires descend upon the party. It appears that the pieces of the ORACLE OF TENÇUR have been strewn about in hopes that it would lead adventurers deep within the catacombs. After combat, the party finds another piece of the ORACLE OF TENÇUR.

**54** This teleporter leads to the "Maze of Columns" at location 10.

**55** The party finds treasure in this room.

**56** Spiked traps. If a thief does not detect the trap the first time the party steps on it, it becomes active. The second time it is set off.

Upon returning the circlet to him, the party is rewarded with treasure, including a piece of the ORACLE OF TENÇUR.

Treasure: *fine long bow*

**47** This door opens if the party uses the GOLDEN KEY they received from Fastillion at Luminari. If they use the RUSTED KEY, it melts and becomes useless. The stairs lead to the catacombs at location 48.

**48** The entrance to the catacombs.

**49** A single intact coffin occupies this room. If the characters open it, they are immediately set upon by undead. Searching after combat in the upper right corner of the room reveals a secret door in the coffin.

**50** This room is the resting place of holy men. The party should not ransack their coffins.

## Hulderfolk Wood

**Synopsis:** Enchanting perfumes draw the party through a mountain tunnel, and into a sheltered wood. They find that their food is gone, and hunger gnaws at them. After a while, they stumble across Tasslehoff Burrfoot, equally lost, who tells them that they have entered the realm of the Hulderfolk elves. When they rest, a single elf whispers to them the Hulder words necessary to befriend the archaic elves.

Using the ritual words, the party enjoys a banquet, and is brought before the Hulder King and Queen for a ritual of words. The Queen asks the party to swear an oath: never to cut any wood off her beloved trees, nor carry off any of her children.

## Hulderfolk Wood

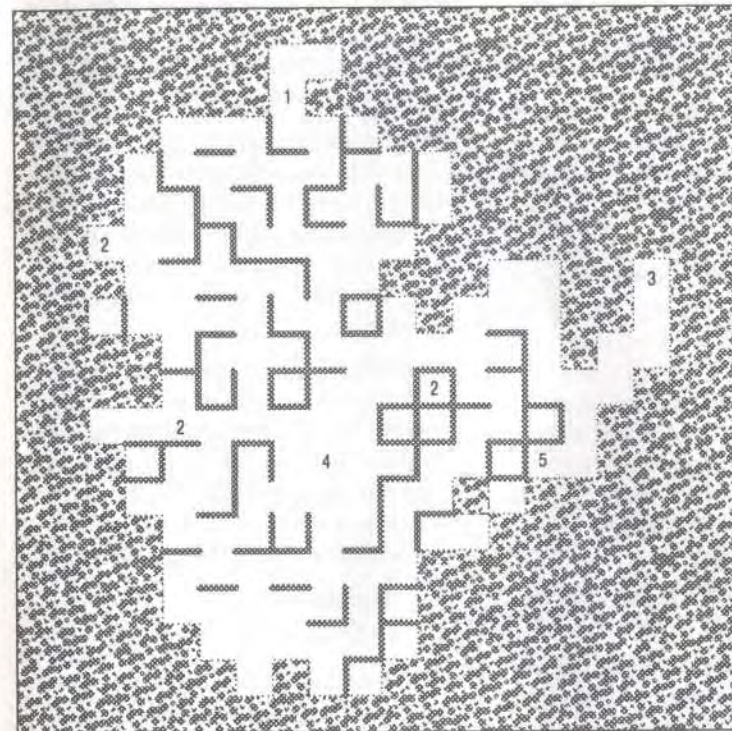

In order to escape more time-consuming rituals, the King gives the party a task: count the leaves on the Mother of Trees before they fall. Despite the Queen's legal twists, the party solves the puzzle. After a celebration with the elves, the party rests, only to discover upon waking that the spiteful Queen has caused a whole month to pass. The party meets the helpful half-elf Elea as they leave, and she asks a seemingly impossible request: to find her true mother, who does not even know she bore Elea.

**Wandering Monsters:** None.

**Resting:** The party may rest anywhere. Resting allows the elf changeling Elea to teach more Hulder words to her favorite in the party.

Note: Attacking the Hulder people, or failure in the ritual of words may invoke the dreaded Hulder punishment of shunning — slow death by starvation.

### Map Locations:

**1** A mountain tunnel that remains hidden until one day after the party solves the leaf riddle.

**2** Tasslehoff Burrfoot may be found at one of these locations.

**3** A spring. Drinking water refreshes the party.

"Hulderfolk Wood" continues...

**4** The Banquet Meadow. When eligible to meet the Hulderfolk, a voice challenges the party. The correct response, **GEBENE**, reveals a hidden banquet.

Many combinations of replies may succeed with the Hulderfolk Queen. One such combination: **GEBENE, SHUWARA, LIMENE, BILBARA, LIMENE.** *ENTRY 29*

After the characters fulfill their leaf-counting task, the Hulder King awards them with many magic objects. He also presents them with the **RING OF DECEPTION**, which glows in the presence of disguised draconians, and an **IRON DRAGON SCALE** necklace made from a dragon scale. This necklace proves invaluable when the party meets Tremor, leader of the evil othlorx dragons.

Treasure: *elfin chain+4, composite long bow+4, 20 arrows+4, potion of speed* *HOLBANI*

**5** The Mother of Trees. Cutting the tree or burning its leaves brings on disaster. Plucking the leaves, which are beginning to fall anyway, solves the riddle. Elea may also appear, and use her Hulder power over time to cause the leaves to drop. In either case, only one leaf is left on the Mother of Trees.

### New Aurim

**Synopsis:** On their search for draconians in Taladas, the characters enter the capital of the Thenol Empire. They discover that the Thenolians are preparing for war and that there are draconians in the King's palace. The party is offered the opportunity to join the Thenol army and given **THENOL ARMY UNIFORMS**. If the characters wear the uniforms, they are less likely to be attacked and can get into the front or rear entrance of the palace with a **CLAY PASS**. While exploring the city, the party hears about

rebels being held hostage in the city prison. If the party rescues them, then supporters of the rebellion provide safe resting and training, and give valuable information and equipment to the party.

**Wandering Monsters:** There are four Thenolian press gangs run by the Hith temple inquisitors. If the party is not wearing uniforms, they attack on sight. There is an opportunity to take their **THENOL ARMY UNIFORMS** after each encounter.

**Resting:** The best places to rest are with the rebel supporters. There is an inn but there is one group of Thenolian fanatics that frequent it. All other buildings are periodically invaded by press gangs and other local menaces. The party cannot rest in the city streets.

### Map Locations:

- 1 The city gate.
- 2 Thenol guards ask the characters if they want to join the Thenol army. If they do, they are escorted to location 3.
- 3 The party can hear rumors from Thenol soldiers. **THENOL ARMY UNIFORMS** may be gathered if the party attacks the guards.
- 4 Thenol Army Quartermaster. The party may also get **THENOL ARMY UNIFORMS** here. As long as the soldiers in the previous room are still alive, the quartermaster sells the party equipment.
- 5 Senators' offices. If searched, letters are found.
- 6 Pub of the Grinning Dead. The party may talk with Thenolian soldiers and a hooded baaz draconian.
- 7 A junior priest of Hith can heal the party. If the characters are wearing **THENOL ARMY UNIFORMS**, they may pick up their orders here. The **SPECIAL**

### New Aurim

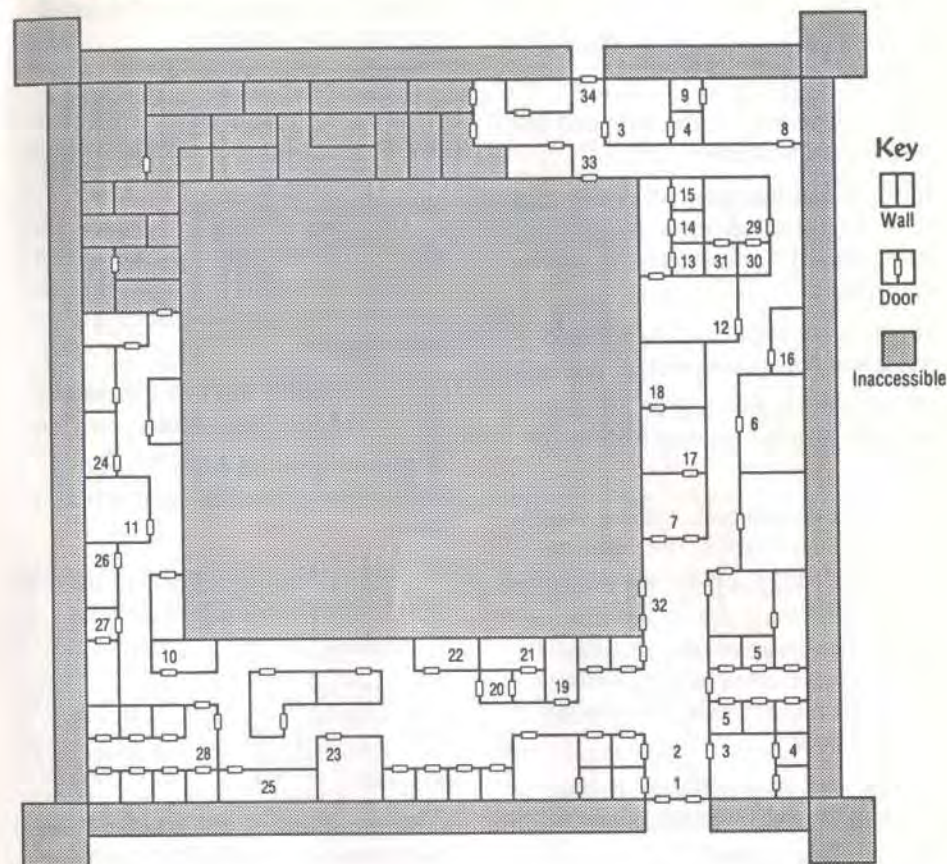

**BLESSING** brings the party face to face with the gathering of Hithite high priests and their servants at location 18.

**8** If the party has been to the Hith temple, the Thenol army lieutenant directs the characters to the Commander's house for their **CLAY PASS**.

**9** The private office of the Army Commander. Papers tell the party about the recruits being taken to Hawkbluff.

**10** Home of the Thenol Army Commander. If the party is wearing uniforms and knows about the recruit escort trips to Hawkbluff, he gives the party a **CLAY PASS**.

**11** The Quiet Kender Tavern. A Mislaxa cleric tells the party about rebel hostages in the city prison and asks the party to free them. Upon the party's return, he gives them a **MISLAXA TALSMAN** that identifies the party to friends of the rebellion.

**12** The City Prison. Temple inquisitors are torturing an old man. If he is rescued and the party casts a healing spell on him, he tells the party about the "Quiet Kender Tavern."

"New Aurim" continues...



- 13** The party may free men locked in a prison cell.
- 14** The party may free an old man locked in a prison cell.
- 15** The party may free women and children locked in a prison cell.
- 16** A rebel sympathizer allows the characters to rest in his home after they have rescued the hostages. He can also train mages.
- 17** The party is attacked by a Thenol priest and his congregation of undead.
- 18** The party is attacked by a gathering of Hithite high priests and their servants.
- 19** A baaz draconian is making swords for draconian recruits. The party can find out what the draconians are doing in the palace.
- 20** A junior priest of Hith offers the characters a chance to enter the service of Hith and directs them through the next door.
- 21** The party is immediately attacked by a high priest and other followers of Hith.
- 22** A den of vampires.
- 23** The party uncovers an enchanted aurak draconian magically disguised as a local senator.
- 24** The Mislaxa temple gives healing and allows resting if the party is not wearing uniforms. If the characters have rescued the prisoners from location 12, they may rest freely regardless of what uniforms they are wearing. The priest also gives them a scroll and a CLAY PASS if they agree to explore the palace.
- Treasure: cleric scroll (heal, heal, restoration)

- 25** A rebel hideout. After the party has rescued the hostages from the prison, they may rest and train.
- Treasure: short sword+4
- 26** A magic shop friendly to the rebellion. It sells magical items and THENOL ARMY UNIFORMS.
- 27** The Home of Senator Pakland. After rescuing the hostages, Pakland allows the party to rest in his house and gives the party information about New Aurim and the palace.
- 28** Inn. The party can rest but might be interrupted by a Thenolian press gang.
- 29** Thenol Army Barracks. If wearing their uniforms, the party may rest and train.
- 30** Thenol Army Paymaster's Office. The party finds a strongbox full of steel.
- 31** An empty office.
- 32** Front entrance to the palace. If the characters are wearing THENOL ARMY UNIFORMS and have a CLAY PASS, they may enter.
- 33** Rear entrance to the palace. If the characters are wearing THENOL ARMY UNIFORMS and have a CLAY PASS, they may enter.
- 34** The rear exit from the city.

### Palace of the Thenol King

**Synopsis:** Wearing enemy uniforms, the characters enter the first ring of the Palace of the Thenol King, seeking more information about draconians. With a CLAY PASS, they descend to the dungeon, pass by barracks teeming with draconians, and learn of plans to use the Thenolian army to gather vast new stores of dragon eggs. The party is given draconians to escort to Hawkbluff, but these are soon ambushed and

### Palace of the Thenol King: Dungeon

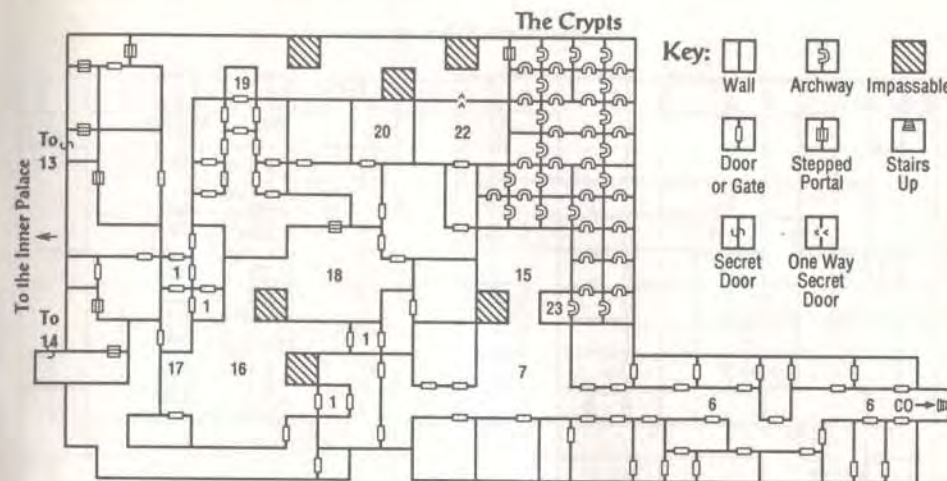

killed by Thenolian rebels. The party then ascends to the second ring of the palace, largely abandoned to monsters, and then to the inner palace. The Thenol King, a puppet of Tyrant Trandamere, is unhelpful, but the Queen tells what she knows about the draconians' plans, and urges the party to disrupt their operations. The party also meets Grunschka, a dwarf, who joins them against the draconians. Descending again to the dungeon, the party disrupts a mass corruption of dragon eggs, and the draconians abandon the palace.

While in the palace, the party learns that the BOOK OF AMROCAR, stolen from Kristophan by Thenolian agents, could greatly aid the draconians' plans. The book has been sent to Hawkbluff by Trandamere and must be recovered before the Thenol army moves on Blackwater Glade.

**Wandering Monsters:** Draconian patrols occupy the lower levels and assorted types of monsters wander the upper levels of the palace.

**Resting:** Rest is impossible on the first level or in the dungeon until the gong that sounds every few minutes is destroyed. The party can rest anywhere on the upper levels.

#### Map Locations:

- 1** Guard Gates. These gates are open, locked, or occupied by draconian guards at various times.
- 2** Empty guard barracks.
- 3** Thenol officials may sell the characters THENOL PALACE UNIFORMS or THENOL ARMY UNIFORMS if they have a CLAY PASS.
- 4** Kitchens.
- 5** Draconian guards challenge the party. After the combat, the party can recover and reassemble a clay tablet, which reveals that the BOOK OF AMROCAR is in Hawkbluff.

"Palace of the Thenol King" continues...

## Palace of the Thenol King: First Ring

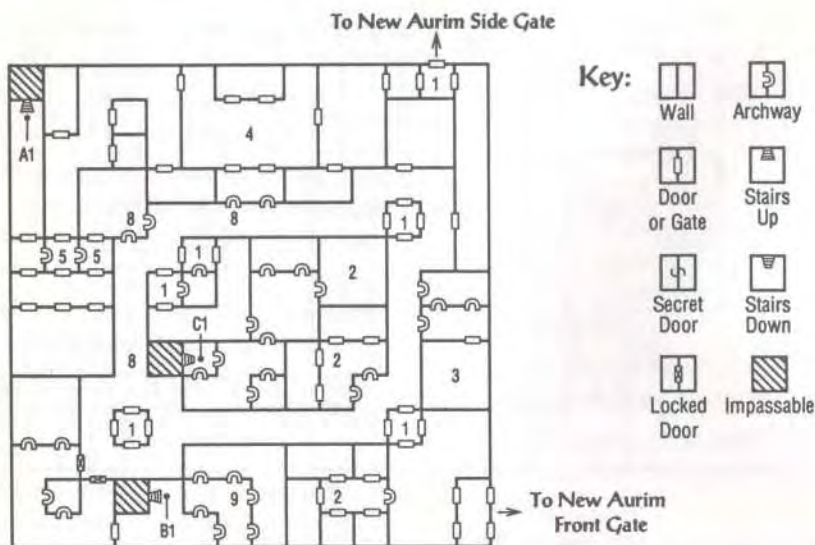

**6** Draconian barracks. Departing from the main path brings on a horde of draconians.

**7** An aurak speaks for the Dark Queen, and tells the Thenol-garbed party to escort a squad of newly-hatched draconians to Hawkbluff.

**8** Thenol rebels lurking nearby slaughter the draconian recruits that the party is escorting.

**9** Abandoned areas. Various undead and wild monsters may be found in these areas.

Treasure: *plate mail+3, red mage scroll (slow, ice storm, iron skin)*

**10** The draconians in these guard posts were overwhelmed by Thenol rebels on their way to see the King. Grunschka can be found here.

**11** After the Thenol rebels overwhelmed the draconian guards at location 10, they left their uniforms in this room.

**12** The Inner Palace of the Thenol King is dilapidated and almost deserted. After visiting the inner palace, the party meets Grunschka, a draconian-hating dwarf, who may join the party. She is encountered at the next guard gate that the party visits at location 1 or 10. Once the party receives Grunschka's warning about the draconians, they have a limited amount of time to find and disrupt the egg corruption ritual at location 18.

**13** The Thenol King. He listens to the party, but is unconvinced that Trandamere or the draconians pose any threat to Thenol.

**14** The Thenol Queen. A mysterious man in black robes has appeared to

## Palace of the Thenol King: Second Ring and Inner Palace

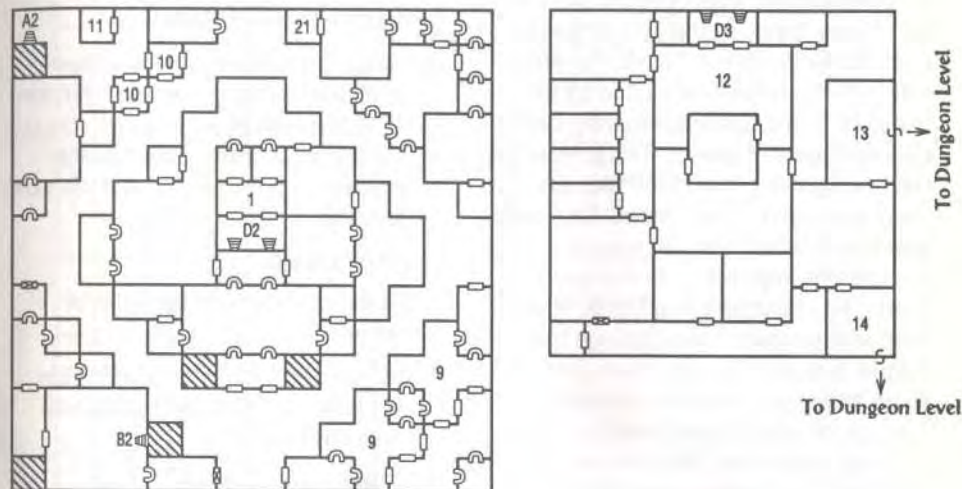

her in a dream and urged her to help the party. She tells the party about the draconians in the dungeon, and reveals a secret passage behind the fireplace. She also gives the party her **SIGNET RING** that identifies the party as a friend to the jeweler at Hawkbluff.

**15** This temple celebrates the evil Hiteh the Merchant, patron god of Trandamere.

**16** This temple is dedicated to Takhisis.

**17** Gong of Chaos. The characters can destroy it without mishap if they wait until the turn of the hour.

**18** The Corruption Gathering. Waves of evil servants try to prevent the party from disrupting the corruption ceremony. If the characters persevere, they can prevent a mass hatching of draconians, and the draconians abandon the palace.

**19** The Vault. The party finds that it is empty of dragon eggs.

**20** Chambers of the Evil Priests. The party is attacked by a crazed cleric.  
Treasure: *mace of disruption*

**21** A death dragon lair.

**22** Clerics prevent the party from reaching Trandamere, who is burning his papers at the fireplace. Trandamere flees and leaves treasure.

Treasure: *ring of fire resistance*

**23** Beholders and other assorted monsters defend their lair.

**A1-A2, B1-B2, C0-C1, D2-D3** These stairways connect the levels.

## Hawkbluff

**Synopsis:** The temple to Hith at Hawkbluff is a powerful fortress that contains a labyrinthine network of secret passages and is also home to the Tyrant Trandamere, de facto ruler of Thenol. Movement within the fortress is regulated by a series of guard stations requiring eight different types of passes. The jeweler in the town outside Hawkbluff aids the party by forging these passes. The party also learns that Davik, the temple's architect, is imprisoned in the lower level. The characters free Davik, who is then able to guide them through the temple's maze. The party then finds the room where generals are plotting the invasion of Blackwater Glade, using the *BOOK OF AMROCAR*. After recovering the book, the party escapes the temple through a secret door with Davik's aid.

The fortress of Hawkbluff cannot be entered until the palace in New Aurim has been completed. The party should first try to disrupt the egg conversion ceremony there, which causes Trandamere to flee to Hawkbluff. If the characters enter Hawkbluff before completing the palace, they are not able to obtain a *KEYHOLE PASS*, which would gain them entrance to the fortress.

Hawkbluff is a powerful fortress, and combat with guards or regulars eventually triggers drastic defense measures.

**Important Note:** You need Davik to get through the secret doors on levels two and three.

**Wandering Monsters:** Wandering monsters are always a threat in the area beyond the prison, in the catacombs, and in the secret passageways. The

characters may wander the temple proper without fear of battle unless they attack, refuse to leave a room when ordered, or enter the room containing the *BOOK OF AMROCAR*.

**Resting:** The party may rest without disturbance in rooms containing monsters, in the area beyond the prison, and in the catacombs, after suitable arrangements have been made with the inhabitants.

### Map Locations:

**1** Entrance and exit to the town at Hawkbluff.

**2** The jeweler's. Give the jeweler the *SIGNET RING* and he forges passes to get into the fortress.

The eight pass types are:

- |             |            |
|-------------|------------|
| 1. KEYHOLE  | 5. SWORD   |
| 2. LANTERN  | 6. SWAMP   |
| 3. BATON    | 7. QUILL   |
| 4. ZIGGURAT | 8. INCENSE |

The first three are most important. When obtaining a *LANTERN PASS*, the jeweler asks if you want a *RELEASE* form. When asked what name, say **DAVIK**. After obtaining several passes from the jeweler, the authorities catch on and kill him.

**3** A cleric official sells a *KEYHOLE PASS* to the party for 1000 steel.

**4** A training hall, which charges 1000 steel for training.

**5** Shops.

**6** Guard post and main entrance to Hawkbluff. Requires the *KEYHOLE PASS*.

**7** Side entrance and guard post. Requires the *BATON PASS*.

**8** Side entrance and guard post. Requires the *INCENSE PASS*.

## Hawkbluff: Catacombs and Dungeon

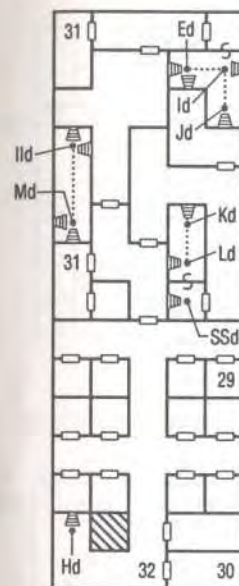

### HawkBluff Dungeon

**9** The inn. The party can safely rest in the room to the east.

**10** Regular troop barracks. Safe resting, but the party is interrupted every eight hours as the guard changes.

**11** Kitchen. The *BOOK OF AMROCAR* is found here after the battle with the generals on the 4th Level.

**12** Exit from the temple. The party must have the *BOOK OF AMROCAR* and Davik with it to manipulate the lock on this door.

**13** Barracks containing undead.

**14** Guard posts. If the fortress is on alert, they attack immediately, otherwise, the guards just restrict the party's movement. The party must have the proper passes to get through these locations.

**15** Library.

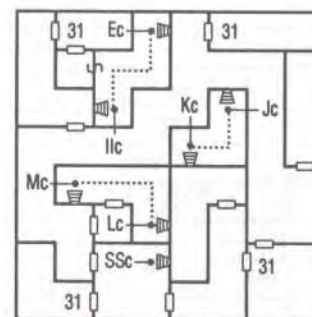

### HawkBluff Catacombs

**16** Armory containing only low-grade weapons.

**17** Barracks containing bakali troops. If the party successfully battles them, it finds a *QUILL PASS*.

**18** In one of these rooms the party finds a *LANTERN PASS* and a *DAVIK RELEASE* form.

**19** Treasuries. This room is filled with steel, gems, and jewelry.

**20** A functionary mistakenly gives the party a *SWORD PASS*.

**21** The party encounters a lone priest. Killing the hapless fellow produces a *KEYHOLE PASS*.

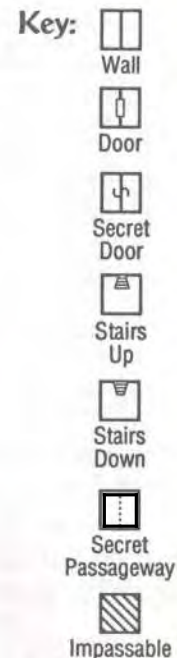

"Hawkbluff" continues...

### Hawkbluff: Level One

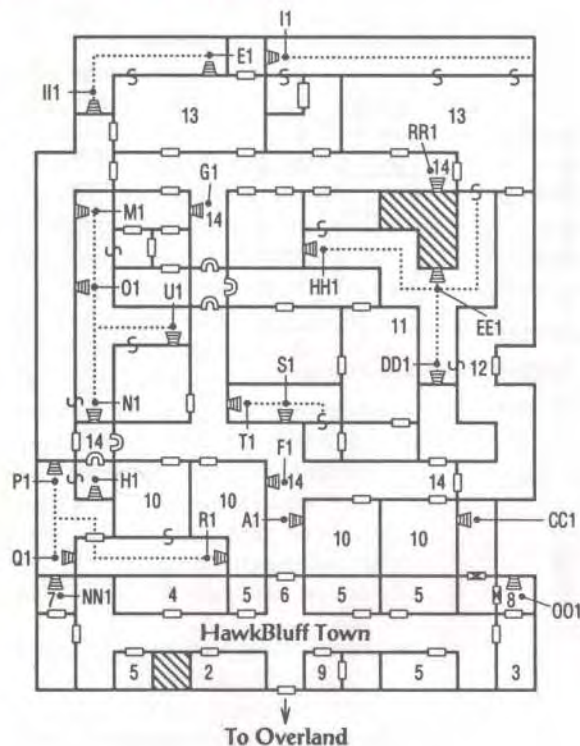

#### Key

- Wall
- Door
- Archway
- Secret Door
- Blocked Door
- Stairs Up
- Stairs Down
- Secret Passage
- Impassable

### Hawkbluff: Level Two

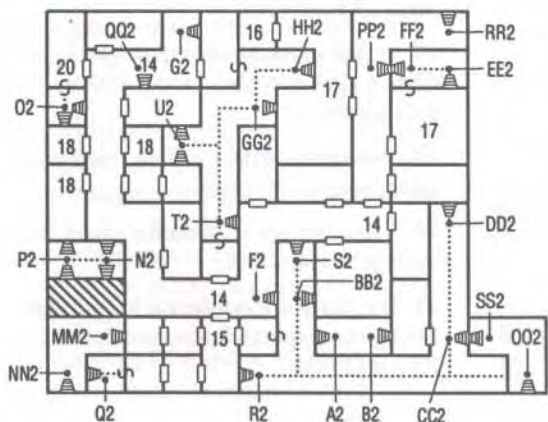

### Hawkbluff: Level Three

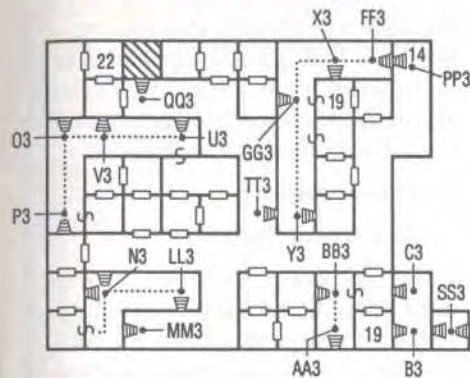

### Hawkbluff: Level Four

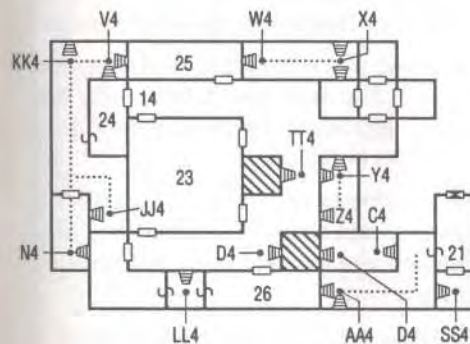

**22** The party finds a ZIGURAT PASS on a desk in this general's room.

**23** The Thenolian Senate.

**24** Side room where Trandamere and Thenolian generals are reviewing the BOOK OF AMROCAR. In the battle which ensues from the party's entry, the book is thrown on a dumbwaiter to the Kitchen at location 11, and Trandamere flees in panic, ordering his bakali bodyguard to kill everyone in the fortress until the book is recovered.

Treasure: wand of fireballs, 10 darts+4, boots of speed — received only if the party pursues Trandamere

### Hawkbluff: Top Level

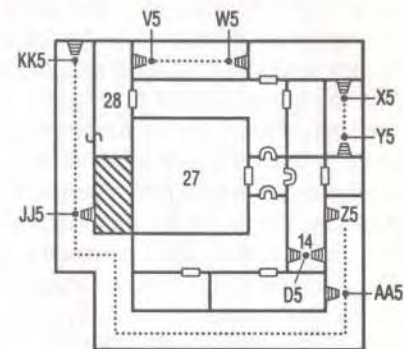

**25** Briefing room packed with soldiers and priests during the day. Starting a fight is dangerous.

**26** Draconians. If attacked, the party learns of the draconians' intentions to betray the Thenolians.

**27** Main temple to Hith.

**28** Side altar, where priests are corrupting dragon eggs into draconians.

Treasure: *potion of extra healing*

**29** Davik's cell. The party can leave the cell, or request directions from Davik, by using SEARCH or LOOK. Davik can only point out directions to the requested location (his tongue has been removed.)

**30** The PRISON KEYS to release Davik may be found in this room.

**31** These rooms contain monsters and are safe after the inhabitants have been evicted.

**32** The jailer meets the party here and leads the characters to Davik if they have the DAVIK RELEASE form.

**A-TT (c,d,1-5)** These stairways connect the different levels.

## Bai'or

**Synopsis:** The village of Bai'or has been occupied by "Sharkmen," who are forcing the villagers to build boats. But the Sharkmen are actually working for draconians, who took over the town and left it in the control of the Sharkmen as a staging ground for their conquest of Ansalon. The boats are intended to carry a great army back across the sea. The Sharkmen aren't trustworthy allies, so the draconians left a group of evil dragons to keep them in line.

The party may gain experience and treasure by defeating the Sharkmen and the thugs, who are really just Sharkmen in street clothes. The leaders of the Sharkmen are in the Town Hall. However, the party cannot defeat the endless hordes of Sharkmen themselves. They need to find the village Elder, Anthela, in the Library in order to raise the villagers against the Sharkmen in a climactic battle. She also tells them to go to Aldinanachru and warn the gnomes about the draconian threat. Then the party can go to the woods north of town and fight the evil dragons. After defeating these dragons, the party meets a sadly deformed dragon, who was being held captive by the others. She tells the party that she was created in a failed attempt to create a dragon host through which Erestem can enter the world. If the party helps her recover, she tells them to go to Blackwater Glade and seek the aid of the othlorx dragons.

**Wandering Monsters:** Sharkmen patrol the town. The patrols keeps coming until the party enlists the aid of Anthela, the village Elder, to raise the town and help the heroes wipe out the Sharkmen.

**Resting:** Before Sharkmen patrols have been eliminated, the party may rest in the homes of villagers (but not the homes of Sharkmen/thugs) and in the secret room in the library. After defeating the Sharkmen, the party may rest at the inn or in the secret room.

### Map Locations:

- 1 This is where the party arrives.
- 2 The boat works. These are the locations where boats are assembled. There are always villagers here, but they are afraid to talk. Some of these people are Sharkmen.
- 3 The sheds where the people of Bai'or store their boat-making tools and materials.
- 4 Home of a reclusive village fisherman named Eric Strongbond. Eric thinks that Oleg Hamhand is the cause of the current troubles in Bai'or.
- 5 The homes of villagers. When the party meets villagers at home they are much more inclined to explain what they know.
- 6 There are Sharkmen living in these buildings.
- 7 Town Square. The party should remain inconspicuous unless they are looking for a fight. (After visiting Anthela, this is the site of the climactic battle against the Sharkmen.)  
*Treasure: ring of fire resistance, bracers AC 2*
- 8 Town Hall. This building is occupied by the leaders of the Sharkmen.  
*Treasure: scimitar+4*
- 9 This is the home of Oleg Hamhand and his family. Oleg thinks Eric Strongbond is in league with the Sharkmen.
- 10 The Library.

## Bai'or

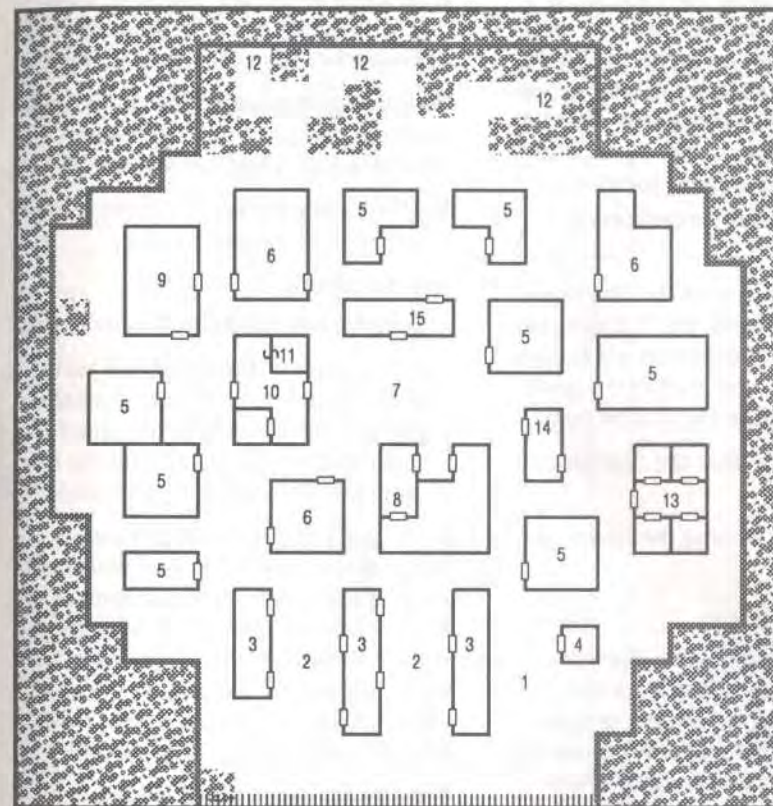

### Key

-  Wall
-  Door
-  Secret Door
-  Forest
-  The Edge of Town / Exit to Overland
-  The Harbor

**11** This is the hiding place of Anthela, the village Elder. Anthela tells the party about the gnomes of Aldinanachru and the draconians on the shore of the Lava Sea. Because the characters now know the whereabouts of the draconian army, they are able to travel to Blackwater Glade and get the othlorx dragons there to bring them to the gnome citadel. If the party promises to defeat the evil dragons at the north end of town, Anthela helps the party muster the villagers against the Sharkmen. Otherwise, she musters the villagers after the party com-

pletes the third dragon battle. The party cannot free the village without her help.

**12** These are evil dragon encounter locations, but only after the party has met Anthela. In the first encounter at any of these locations, the dragon doesn't take the party seriously. In the second encounter the dragon flees. The third encounter is a tough one against many well prepared dragons. If the

"Bai'or" continues...

characters leave Bai'or after meeting Anthela, but without completing the third encounter, a large group of dragons swoops down on them. In either case the party gets a scroll after defeating the third group of dragons. After this, the deformed dragon can be encountered at any one of these locations.

**Treasure:** *scroll of protection vs. dragon breath*

**13** This is the inn. After the Sharkmen have been eliminated, this is a safe place to rest. The evil dragons do not think to look for trouble here so this is a good place to rest before the dragon battle.

**14** A magic store after the Sharkmen leave.

**15** A general store after the Sharkmen leave.

### Blackwater Glade

**Synopsis:** The party gives the IRON DRAGON SCALE obtained from the Hulderfolk to the red othlorx dragon, Tremor, whose lair can only be reached with the aid of a secret word written backwards in the BOOK OF AMROCAR obtained in Hawkbluff. Along the way the party meets a wandering bard, Baldric, who is in reality the silver dragon, Baldranous. Baldric seems to flee in the face of danger, but he actually is evaluating the party's worthiness. Later, he leaves the party to secretly smash opponents ahead. If the party allows Baldric to join them and does not drop him, they are later rewarded with a magic item. If the party has learned that the draconians are

camped by the Lava Sea after the scale is returned to Tremor, the silver dragons fly the party to the gnome citadel at Aldinanachru from the lair of Clematra.

**Wandering Monsters:** The party is constantly in danger of meeting swamp monsters and Thenolian patrols.

**Resting:** Only the lair of Clematra, a silver dragon, is completely safe.

#### Map Locations:

**1** Entrance and exit to Blackwater Glade.

**2** Before visiting Hawkbluff, the party may overhear a swamp leader concluding a deal with a bakali, hiring them in Trandamere's name to aid with the upcoming invasion of Blackwater Glade.

**3** The party may encounter a young bakali undergoing his test of manhood, fighting a crocodile in single combat. If the party does not interfere with the test, and truthfully testifies on behalf of the young bakali, Zarketh, he eventually rejoins the party as a guide. This favorably affects random encounters.

**4** Approach to the lair of Baldranous. No gain awaits the party down this path, merely damage from falling rocks as Baldric/Baldranous protects his lair.

**5** The lair of the silver dragon, Clematra, who is Baldric's mother. When Tremor and Baldranous have set off to destroy the Thenol threat, and the party has learned the whereabouts of the draconians' camp in Bai'or, othlorx dragons urge the party to accept air transportation to Aldinanachru to enlist the aid of the gnomes.

**Treasure:** *wand of ice storm, silver shield+3* — received only if the party hasn't antagonized Baldric

### Blackwater Glade

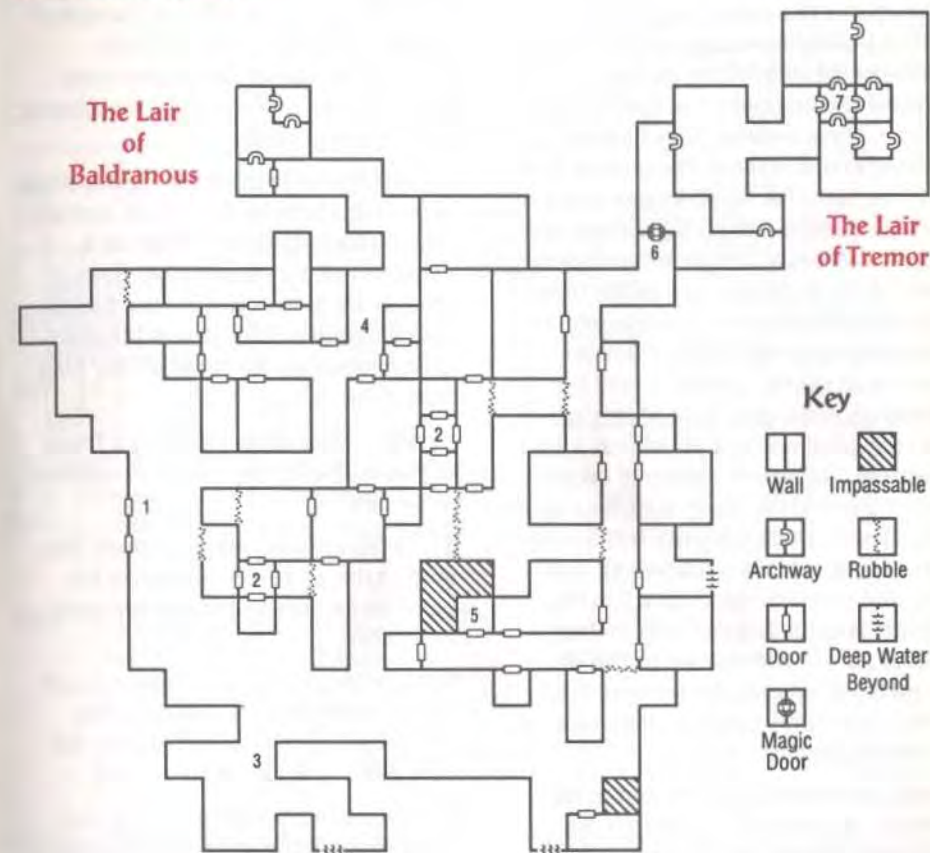

**6** Approach to Tremor's lair. Tremor endlessly demands more tribute from the party. If the party attacks, he cravenly flees inside the cavern. The secret word to open the door is **HABOILJX**.

**7** Tremor's Inner Sanctum. If the characters are willing to give the IRON DRAGON SCALE to Tremor, they are rewarded with a magic ring. If they win the combat with invading Thenolians,

they witness a drama where Tremor's leadership is impugned by another dragon. To prove his bravery, he directs a member of the party to place a vorpal sword lightly on his neck. If the character does so, the party is rewarded with the blade.

**Treasure:** *ring of wizardry* — doubles 5th level spells, *vorpal long sword*

## Aldinanachru

**Synopsis:** The characters fly to the Citadel of Aldinanachru on dragon-back to enlist the help of the gnome armies against the draconians at the Tower of Flame. Upon arriving, they find the citadel in utter chaos. The gnome King has decided that he no longer wants his people divided into social classes, and has mandated a complete transformation of the work structure of the citadel. Gnomoi gnomes, who used to be the designers and engineers, are now moved to worker positions, and the minoi gnomes, who were always proud of their positions as the builders and creators, are now in charge of creating and designing the many contraptions in the citadel. Once the party realizes that the King is actually a draconian, and that the mayhem taking place in the citadel is actually a carefully orchestrated plan to prevent the forces of good from utilizing the gnomes' fire-fleets and windships, the search for the true King begins.

Once the true King is restored to his throne, the characters travel to the Tower of Flame to defeat the evil forces and thwart the Dark Queen's plan. Upon completing this task, they return to the gnome citadel to celebrate their victory. However, during the victory celebration, the evil othlorx dragons, led by Tremor, burst into the palace and attack the forces of good.

**Wandering Monsters:** None.

**Resting:** Each level of the citadel has at least one safe room to rest, and the guest quarters also have an inn to rest in. Rest may be interrupted in any other location.

### Map Locations:

**1** The Palace Waiting Room. Tasslehoff brings the party to meet Captain Daenor. The two of them have been waiting for an audience with the gnome King for several days.

**2** The characters meet the gnome King, who offers them no help at all, and any questioning merely brings about a demand that they leave. The glowing RING OF DECEPTION reveals the King to be a draconian. They defeat the disguised monsters while the phony King runs away.

After the party returns from the Tower of Flame, the victory celebration takes place here.

**3** The "renovated" elevator shaft. The drop to the main level damages the party, so be sure to prepare the party for the fall.

**4** The main air-lift of the citadel is currently undergoing renovations. The party is asked to choose between the WORKSHOPS, GUEST ROOMS, or PALACE.

**5** If Grunschka is with the party, she warns the party that she smells draconians.

**6** Storage yard for the gnomes' fire-fleets.

**7** The party encounters draconians disguised as gnomes. Choosing LEAVE allows the party to avoid this encounter.

**8** The party meets the newest windship captain, Perkelanamord.

**9** In the largest shipyard, the party encounters several disguised draconians.

After the King has been rescued, this location becomes the assembly point before the battle at the Tower of Flame, and the arrival point after the war is won.

**10** Large pots are filled with cooling lava.

## Aldinanachru



Key:



**11** The party overhears draconians discussing their plans to keep the citadel in chaos. Unfortunately, they see the party and attack.

**12** This room is safe to rest in.

**13** Whispering voices foreshadow an encounter with several aurak draconians preparing spells. Cast a *dispel magic* to enter the combat unharmed and gain extra experience.

**14** Draconians charge down the hall and attack.

**15** The draconians have fused this door shut and sealed off the western wing of the citadel.

**16** Minoi gnomes are hard at work repairing a hole in the floor as a gnomoi gnome looks on in frustration.

**17** The Temple of Reorx.

**18** Leonard Minoi's Bar & Grill.

**19** A thief dressed in black approaches. Handing over all of the party's money avoids the combat with gnome thieflords.

**20** The Hall of Enhancement. This is a good place to train characters.

**21** A sign informs the party that the wing is closed for renovations.

*"Aldinanachru" continues...*

**22** A magic portal mistakenly opened by a group of experimenting gnomes releases hydras, iron golems, and a lich.

Treasure: *cloak of protection*+3

**23** An unfortunate gnome is caught in his newest invention, a bed that is supposed to lull you off to sleep. Freeing the gnome brings the party extra experience points.

**24** The party bursts in on several draconians taunting a gnome. The gnome is the chief magistrate of the citadel, and goes off to warn others of the draconian takeover.

**25** When the characters enter this workshop, they see several gnomes experimenting with colorful liquids. The tests have not gone well, and one gnome is left holding a bubbling jar. Grab the jar and throw it out the window for bonus experience.

**26** Entering this room interrupts, and probably saves the lives of, several minotaurs conversing with disguised draconians. After the draconians are done away with, the minotaurs decide to scour the citadel and ferret out any other draconians.

**27** Several objects are thrown across the room at the party if it tries to enter.

**28** An old gnome woman, thinking the characters are trying to break into her room and assault her, fends them off with her cane. Guards arrive and usher them out of the room.

**29** A visiting shopkeeper offers to sell the party her selection of bolts and arrows. This is a good place to stock up on magical ordnance.

**30** A small gnome child begs the party to enter the deserted wing and retrieve her runaway cat.

**31** When entering, the party finds several burlap sacks containing the eviscerated remains of many creatures. The bodies all have one thing in common: every drop of blood is missing.

Once the vampires from location 33 have been eliminated, Puddy the cat can be found high up on a shelf.

**32** After Takhisis has been defeated, the King delivers his victory speech, and the party is awarded the greatest gift of the gnome people, the Royal Cheese Nutball! Just as the celebration heats up, Tremor and a large group of evil othlorx dragons blast through the palace walls and attack. The party needs every advantage to win this battle, so enter it prepared! As the party battles the horde of dragons inside the palace, Baldric engages Tremor in a mid-air duel outside.

After this final encounter, the party is free to travel anywhere on the map.

**33** This neatly decorated room is the living quarters of a group of vampires. Searching the coffins, lifting a lid, and looking inside reveals a vampire, who tries to trick the lead character into helping him out of the coffin. Pushing the man away avoids the unwanted bite to the neck. No matter what happens, the other vampires immediately attack.

Treasure: *hoopak*+4

**34** This kennel is actually a room filled with disguised draconians.

**35** The Sleepy Siren Inn.

**36** A poison needle trap guards this locked door. Have a thief disarm the trap or smash the door in.

**37** The magically-protected door resists bashing and picking the lock. CAST a *dispel magic* spell to remove the magic,

### Aldinanachru (continued)

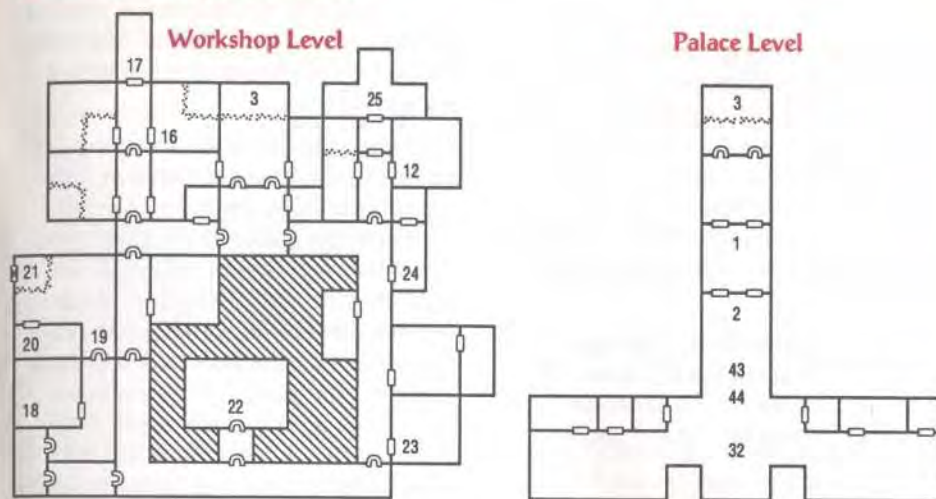

Key:



then PICK the lock, BASH the door down or CAST a *knock* spell to open the door.

**38** Draconians are discussing their infiltration plans. One of the draconians is disguised as the gnome King.

**39** Be sure to rest well before entering this room, because several mages are anticipating the party's arrival and have spells ready to attack. After the battle, the draconian disguised as the gnome King rushes towards the party carrying an innocent-looking weapon. Tell the King to halt, then dive out of the way to avoid the crystal cube.

**40** The teleporter in this room brings the party to the dungeon at location 41, where the true gnome King is being held captive.

**41** When the King warns the party, select LOOK BEHIND YOU. Once the guards

are disposed of, the party is faced with two gnome Kings. However, the real King exposes the fake.

**42** This teleporter brings the party back to location 40. Gnome guards arrive to escort the King back to the palace.

**43** Once the true gnome King has been rescued, the party is transported to this location. The King calls for the War Council and the gnomes prepare their battle plans. Baldric and the othlorx dragon army interrupt the council meeting to offer their assistance. The King gives the party a magic wand and ring to show his gratitude.

Treasure: *ring of invisibility*,  
*wand of lightning*

**44** Various forms of celebration are taking place after the party's victory at the Tower of Flame.



## Tower of Flame

**Synopsis:** The party rides a gnome windship to the Tower of Flame, and leaps through a siege port into the highest level of the fortress. But when Crysia appears, Captain Daenor leads the party toward his sister over a slender bridge. She severs the bridge, and the party plummets down an air shaft to the lowest level of the Tower, losing Captain Daenor.

The characters are then challenged to find their way up to the top again. As they proceed, they need to defeat Tower defenders to help the gnome assault.

**Level 0:** Smash the Tower engines, run by fire giants.

**Level 1:** Defeat beholders; open the siege ports to admit a gnomish force.

**Level 2:** Invade a coven of black wizards; destroy the lair where wounded evil dragons are healed.

**Level 3:** Disrupt the temple where draconians bask in radiant power.

The party must walk through flaming walls and enter the fiery core of the Tower to find ways to accomplish all these feats.

When these operations are completed, the party finds that their windship pilot, Hrumbishnog, has entered the tower airshaft. If the characters jump aboard the craft, they rise to the Tower's top level. There they find Captain Daenor being tortured by his sister who is still under the control of an aurak. If the party breaks the *charm* spell controlling her, the pair escape with Hrumbishnog on the windship.

The party finds a vast hall filled with servants of evil, who speak the mind of the Dark Queen, then attack. Afterward, the party is drawn into the Abyss by a whispering man.

After escaping the Abyss, the party returns to the Tower of Flame to find the gnomes have conquered the top level and now surround the glowing orb, which they feel is the Grathanich, the mystical gem of their creation. Their worship turns to horror when the orb cracks, and a giant five-headed dragon emerges. The party defeats the beast that was to hold Takhisis' spirit. After the combat, the true Grathanich rises from under the egg and begins to float throughout the tower, with the gnomes, draconians, evil dragons and the party in hot pursuit. Eventually the Grathanich falls into a shaft and is lost.

Mission accomplished, the party then meets Hrumbishnog again at an airshaft or siege port, and he sails back to the gnome citadel where everyone is welcomed as heroes.

**Wandering Monsters:** Beholders and many types of fire creatures wander the Tower.

**Resting:** Some small rooms in the Tower of Flame are relatively safe.

### Map Locations:

**1** Upper siege port. The party disembarks here.

**2** Bridge. When the party attempts to cross, Crysia severs the bridge, and the party rides the bridge down to Level 0 at location 3. When the characters return via airship, they may rescue Captain Daenor and Crysia here.

**3** This is where the party ends up, among the rubble of the collapsed bridge.

**4** Fire giants tend the Tower engines.

## Tower of Flame: Level 0

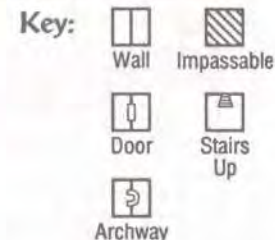
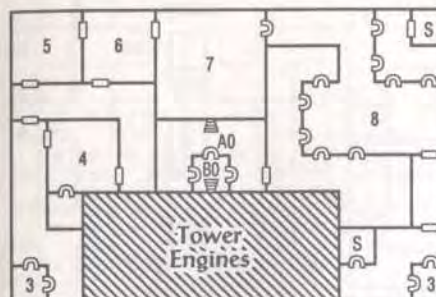

**5** The Casting Room.

**6** The Tool Room.

**7** This is where fire giants have been making siege weapons.

**8** Fire giants and other monsters defend their hall.

**9** The Hall of the Salamanders. Many salamanders lurk among the arches. Knocking down the grisly trophy heads brings them out.

**10** The Manacle Room. The party may destroy the thousands of chains forged in anticipation of the slavery of Ansalon, but this brings angry giants to the room.

**11** Refuge of the fire giants.

**12** Beholder lairs.

**13** Fire creatures strike, coming through the fiery wall at location 16. Later, a gnome bucket brigade pours water against the flame wall at location 16.

**14** Arbalest. A character can use the giant crossbow to kill an attacking beholder.

**15** Draconians have barricaded the siege ports against gnome invaders. The party must open the ports to the gnomes to reach the next level.

**16** The gnomish bucket brigade opens the wall briefly, and the gnomes invade the central core of the Tower. The party can step between locations 16 and 17 by moving through the wall.

**17** Fire creatures move within the fiery walls of the Tower's core and attack from time to time.

After the party returns from the Abyss, draconians bring a mirror for a parley with Takhisis. If the party talks with her, monsters surround the party.

**18** The gnomes briefly unlimber a folding ladder, which the party can take to location 32 on Level 2.

**19** Black wizards summon creatures to help them attack the party.

**20** Defeating the wizards in this room causes the others to flee the Tower.

Treasure: *ring of protection+4*

**21** Dragonloft. Evil dragons heal and re-equip after aerial battle in this room. Attacking quickly retains the element of surprise.

Treasure: *elixir of youth*

"Tower of Flame" continues...

### Tower of Flame: Level 1

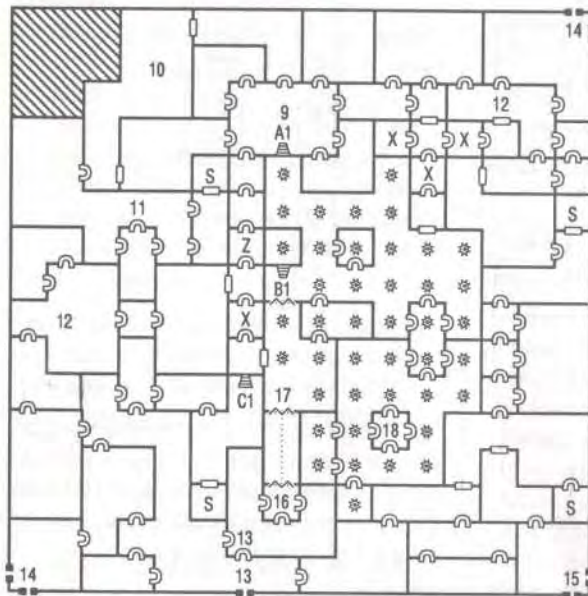

### Tower of Flame: Level 2

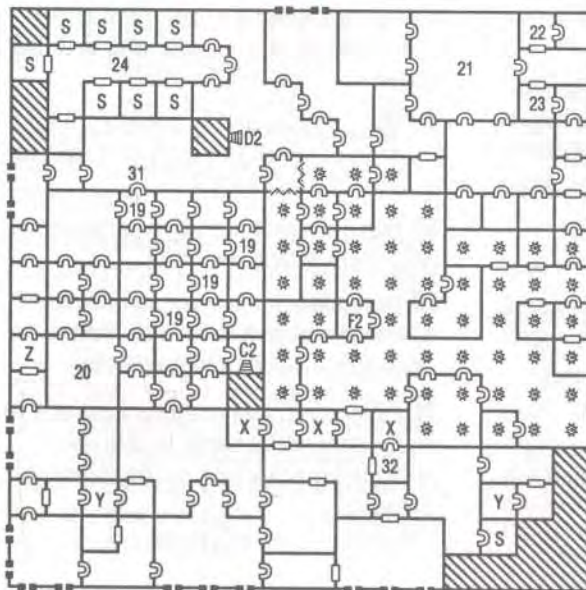

- Key**
-  Wall
  -  Door
  -  Archway
  -  One Way Door
  -  Stairs Up
  -  Stairs Down
  -  Siege Port
  -  Secret Passage
  -  Impassable
  -  Flaming Core
  -  Flaming Wall Leading into/out of the Flaming Core

### Tower of Flame: Level 3

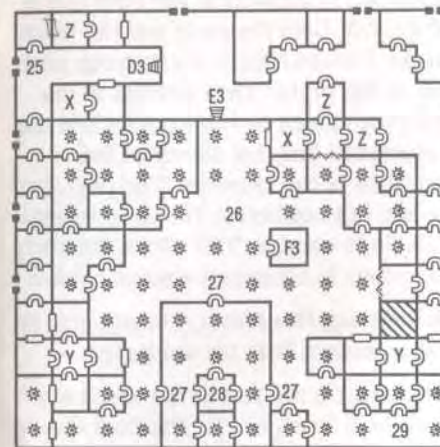

### Tower of Flame: Level 4

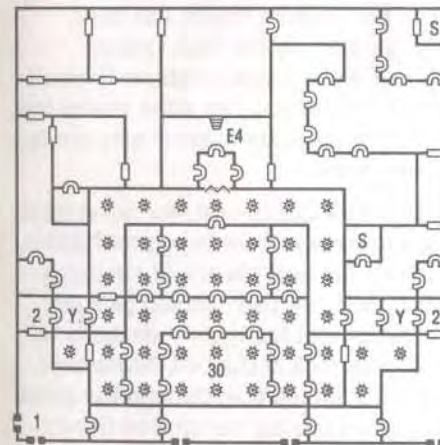

- 22** Entrance shaft. Evil dragons return from battle up this shaft. It can be blocked by releasing a steel gate.
- 23** Exit shaft. Evil dragons use it to exit the tower. It can be blocked with endless flame if a high-level mage commands an invisible rune.

**24** Tower Prison. In the farthest cell the party can free a female mage, Dahmia, the mother of Elea from Hulderfolk Wood. She shares her escape plan with the party. The party ends up at location 25 on Level 3.

**25** Dahmia's escape plan brings the party here.

**26** Experiment Hall. This hall is filled with the grotesque failures of attempts to form the perfect beast to accept the spirit of Takhisis.

**27** Draconian guards try to protect the Font.

**28** Draconians bask in enhancing energy coming from the floor above.

Treasure: 2-handed sword+4

**29** The Master of the Font and other draconians have been cornered in this chamber.

**30** The Temple of Her Return. The party must fight two waves of monsters and draconians to reach the temple. When they do so, Raistlin draws them into the Abyss.

When they return, the characters must fight the five-headed dragon, and then pursue the Grathanich as it floats throughout the Tower.

**31** The party may fight draconians and evil dragons for control of the Grathanich. Eventually the stone plunges down a shaft and is lost forever. The party can then escape the Tower via windship, encountered at a siege port or in the shafts at Y.

**32** This is where the gnomes drop you off from location 18 on level 1.

"Tower of Flame" continues...

**A0-A1, B0-B1, C1-C2, D2-D3, E3-E4**

These stairways connect the levels. Gangs of fire giants brick them up with lava blocks, but after the gnomes enter the Tower, they unblock some of the stairways.

**F2-F3** The lava elevator.

**S** Mostly safe rooms.

**X** These are shafts plunging to floors below. At these shafts, the party may get clues about undisrupted operations in the Tower.

**Y** These shafts are main ones, extending through almost all the Tower. Hrumbishnog flies his windship up through these shafts.

**Z** These sections of floor drop away and plunge the characters down one level if they step in the hole.

**The Abyss**

**Synopsis:** The characters wander the Abyss until they find a circular room. Moving to the center through illusionary walls, they find a black mage being tortured by Abyss creatures. They destroy the creatures to free the mage. He tells them of Takhisis' plan to enter Krynn and lead the draconians to Ansalon, and promises to help them stop the Dark Queen and then to use the portal

to escape. The party finds Takhisis absorbed in awakening the form she is to inhabit. Both the party and the black mage, Raistlin Majere, try to creep past her to her portal. They attempt to distract the Queen by hurling a rock at the ceremonial bell that stands at the entrance of the chamber. The plan succeeds, but not before Takhisis engages Raistlin in combat. This allows the party to escape but leaves the mage behind.

**Wandering Monsters:** A bizarre mix of evil monsters litter the landscape.

**Resting:** Do not rest in the Abyss after Raistlin is freed, or else the Dark Queen enters Krynn and the game is over!

**Map Locations:**

**1** After his unsuccessful attempt to succeed her, Raistlin Majere has been chained here by the Dark Queen. Various weird Abyss creatures torment him at her behest. Since the chains that bind him suppress mage magic, spells do not work.

**2** The Dark Queen waits for her dragon form to emerge from its egg on Taladas. To have the best chance of emerging unscathed, the party should pick the character with the highest dexterity to throw the rock at the bell. Remember, the party should leap through the portal only when the fog has cleared from it.

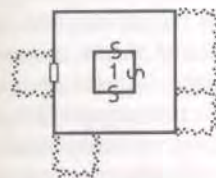
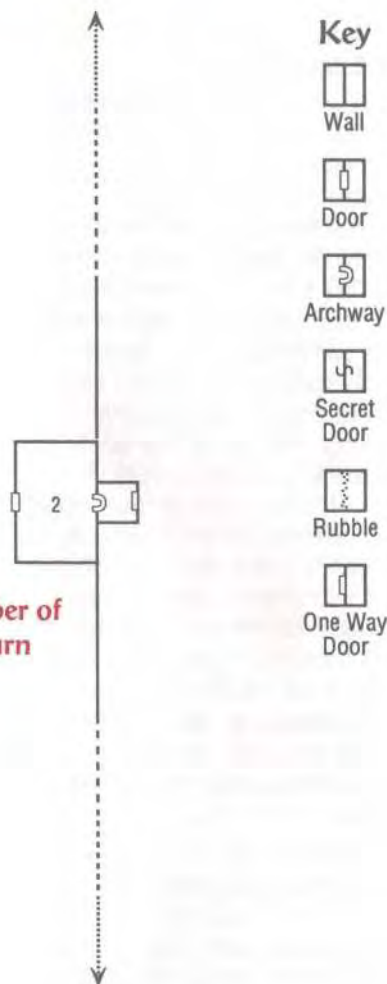
**The Abyss****Cage of Fools****Antechamber of Her Return**

## TIPS FOR WINNING BATTLES

### Combat Spells

There are several mage spells which are effective for wounding or killing large numbers of enemies. *Delayed blast fireball* is easily the best bet against monsters which are not immune to fire damage; there is no delay before it is cast, and it inflicts superior damage. Regular *fireball* and *lightning bolt* spells are also pretty good. It's especially effective to cast a *lightning bolt* at a target standing against a wall so that the bolt bounces off the wall and strikes the target twice. *Cone of cold* is effective at close range, although take care to avoid catching friendly characters in the cone. *Meteor swarm* is useful for causing damage over a wide area. While its damage is relatively light, the impact of *ice storm* (which does not actually do cold damage — the damage is inflicted by hailstones) can be useful, particularly against creatures which are immune to fire damage.

*Mass charm* and *charm monster* are useful for encouraging defections from the enemy. *Hold monsters* (or *hold person* vs. people) are useful for incapacitating several targets. *Summon monsters* is great for conjuring an instant horde, especially if several mages cast it together. *Slow* is effective for making a group of enemies less effective fighters. *Power word stun*, *power word blind*, and *power word kill* spells are really only useful against less powerful monsters.

Against a single monster, *magic missile* causes substantial damage with no delay, although most mages may be invulnerable, because of *shield*, *minor globe of invulnerability*, or *globe of invulnerability* spells. *Disintegrate* is a generic way to eliminate a single opponent, while *otto's irresistible dance* is a good bet against a powerful mage. *Fumble* can also be effective against a single target.

For clerics, the combat spell choices are more limited. *Blade barrier*, employed against a group of enemies locked in melee, causes significant damage. *Flame strike* is a single target spell, while *dispel evil* has specialized utility against creatures summoned from other planes. *Silence*, if successful, prevents key opponents from casting spells. Judicious use of healing spells can greatly enhance the performance of a party's fighters. Both classes can use *dispel magic* to break down the defenses of enemy clerics and mages. Most other combat spells are usually somewhat inferior to the spells listed above, but you may find their effects better suited to your style of play.

### Preparation Spells

Casting appropriate spells immediately before entering combat is a good technique for enhancing the chances of survival for your party. Clerics, rangers, and mages may cast a number of spells before combat which benefits the party.

The cleric spells *bless*, *prayer*, *protection from evil*, and *protection from evil 10' radius* are generally useful spells,

although only the first two protect the entire party; *Protection from evil* must be cast individually on all party members other than paladins, who are already protected. The spells *resist fire* and *resist cold* are very useful against monsters or spells which inflict the appropriate type of damage. These spells frequently create a margin of survival for weaker party members subjected to *delayed blast fireball* or white dragon breath.

The druid spell *barkskin* aids characters attacked in melee or by missile weapons. *Resist fire* is an especially good druid spell to cast prior to fighting fire-using enemies.

A mage spell which can aid the entire party is *haste*; this is a very powerful combat aid, but should be used sparingly because of its aging side effects. Another spell that can help the party is *mass invisibility*, which is occasionally useful when the party is about to be surprised, but is otherwise of quite ephemeral utility. There are a number of spells that a mage can use for self-protection prior to battle; these include *shield*, *detect invisibility*, *mirror image*, *protection from normal missiles*, *fire shield* (COLD is usually better, except against white dragons), *iron skin*, and *globe of invulnerability* (cast this spell last). Spells that mages can cast on any party members include *enlarge* (this is more effective than *strength*), *invisibility*, *fire touch*, and *mind blank*.

### Backstabbing

Backstabbing with thieves is a fairly effective way to inflict massive damage on human-sized monsters. To ensure the effectiveness of a backstab attack, have a thief and accomplice delay

movement until all monsters have attacked. Then have the accomplice attack the chosen victim, after which the thief can backstab the victim by attacking from precisely the opposite direction.

### Underwater Combat

Fighting underwater requires somewhat different tactics from those used in ordinary combat. Missile weapons do not work, party members move very slowly, and blunt or slashing weapons do minimal damage. Furthermore, all fire-related spells don't work underwater, including HOT (but not COLD) *fire shield* spells. *Ice storm* does minimal damage, although the area of effect is larger, and *lightning bolt* acts like a miniature *fireball*. A *ring of free action* allows a character to ignore the movement and combat restrictions of underwater fighting, but it does not affect spell-casting constraints.

Generally, underwater combat may be a little more tedious than normal combat because of damage reduction and slowed movement. It also proves more difficult to scatter the party to avoid massive damage from dragon breath. However, *lightning bolt* and *cone of cold* should provide reasonable substitutes for *fireball*, and strong characters with magic weapons still do significant amounts of damage, even with thrusting weapons. *Rings of free action* should be given to fast-moving, well-armored characters.

"Tips for Winning Battles" continues...

## Dealing with Humanoid Enemies

### Black Rogue, Gnome Thieflord

These thieves are unlikely to present a serious challenge to a full strength party, although they may inflict some damage with their slings before being wiped out.

### Dark Wizard, Thenol Wizard

These human mages don't have a lot of hit points, but they pack a big punch and come well protected. The renegade wizards of Taladas are not constrained by the spell selection limits of the White Robes, Red Robes, and Black Robes of Ansalon, and they are generally well prepared for combat. *Globe of invulnerability*, *fire shield*, and *mirror image* spells protect them from many attacks, and they generally cast *delayed blast fireball* spells at the first opportunity. Magical missile weapons can wound them at long range. *Meteor swarm*, *delayed blast fireball*, and *cone of cold* may be effective spells against them, and *dispel magic* may increase their vulnerability. If a particular bunch of wizards is too tough, consider casting preparatory spells prior to battle, and spread out or mingle with the enemy at the outset of the battle, to avoid having the entire party injured by each *delayed blast fireball*.

### Shark Man, Thenol Fanatic,

### Thenol Warrior, Thenol Warlord

These human fighters all have substantial hit dice and are likely to hit frequently, but they do not do as much damage as the tougher monsters, they have no magical arms or armor, and they have no special protection against magic.

### Thenol Priest

These evil clerics only take half damage from fire and cold, and they cast a variety of unpleasant spells, if allowed. *Delayed blast fireball* spells are still a good bet, even with damage halved, although *magic missile* spells are more effective against single opponents. With light armor and moderate hit points, these vile priests should not be very threatening, as long as you keep them from casting spells.

## Dealing with Monsters

### Bakall

These guys are not very much of a threat, although some care should be taken to keep the shaman from casting spells.

### Beholder

Very tough opponents — they are immune to magic and do not die very quickly in melee. Long range archery is effective, as beholders move slowly and their special capabilities have a limited range.

### Black Pudding

*Fireball*, *magic missile*, and *ice storm* spells are the way to go with these digestive blobs; melee and missile weapons are completely ineffectual, and they are immune to lightning and cold damage. While it is difficult for them to hit, black puddings can permanently damage or destroy irreplaceable magical armor, so consider removing the armor from front-line characters while you destroy these pests.

### Boring Beetle

Not serious opposition.

### Disir, Greater Disir

Disir are not very tough opponents, although fire attacks do limited damage to them. However, greater disir are capable of inflicting substantial damage.

## Draconians

### Aurak Draconian

These persistent monsters have to be slain twice before they stop moving, and after they stop moving they are still dangerous, as they soon explode, damaging and possibly stunning anyone adjacent. Slay them quickly, twice, and then move away before they explode. Most spells are effective against auraks, although their magic resistance may protect them against low-level spellcasters. Auraks can cast *lightning bolt* and *stinking cloud* spells, so it is best to damage them every round, if they cannot be killed outright.

### Bozak Draconian

Bozaks are also spellcasters, and should be damaged every round until slain. They have limited magic resistance; high-level mages and clerics have no problem with them. When slain, bozaks explode, damaging adjacent characters.

### Sivak Draconian

Sivaks are not very tough opponents, but they do have the same limited magic resistance as bozaks.

### Enchanted Aurak Draconian

These are among the toughest adversaries you face in THE DARK QUEEN OF KYNN. They have the same three stages of mortality as regular auraks, but they are much harder to kill, do quite substantial damage, and they can cast very potent spells. While they are not immune to any particular kinds of attacks, their magic resistance may interfere with spellcasters under 30th level, and it's not really worth trying spells under about 12th level. Once it has been slain twice, the enchanted aurak soon explodes with very substantial fireworks. Move all of your characters away from the aurak if possible.

Note that the description of enchanted auraks in the *Adventurer's Journal* is not entirely correct, as an enchanted aurak explosion only affects adjacent creatures, not all those within the radius of a *fireball*.

### Enchanted Baaz Draconian

These are only moderately tough opponents, but their penchant for stealing weapons in the middle of a battle makes it imperative that your fighters carry spares, preferably of the +3-or-better variety. The magic resistance of the enchanted baaz may interfere with spells cast by characters under 20th level.

### Enchanted Bozak

While not as dangerous as enchanted auraks, these draconians are very potent adversaries. In addition to their impressive combat and spellcasting capabilities and their magic resistance, enchanted bozaks enter battle protected by *fire shield — cold*, which makes melee attacks against them hazardous to the attacker. When they are slain, they explode with the effect of an *ice storm*. A high-level *cone of cold* is probably the best bet against enchanted bozaks, although a high-level *delayed blast fireball* into a group of them may kill enough for their own explosions to do in the remainder.

### Enchanted Kapak Draconian

These bad guys are somewhat weaker than enchanted bozaks, but their nasty paralysis attacks and their predilection for splashing pools of acid around when they die makes it desirable to kill them quickly, at long range. *Delayed blast fireball* is the recommended methodology for this task, but the

*"Dealing with Monsters" continues...*

caster should be 20th level or higher to enjoy reasonable odds of defeating an enchanted kapak's magic resistance.

#### **Enchanted Sivak Draconian**

These are extremely potent, highly magic-resistant fighters, and they do devastating damage with backstab attacks if given the opportunity. While they do not cast spells, enchanted sivaks explode with the force of a *meteor swarm* when they die.

#### **Enchanted Traag Draconian**

Enchanted traags are garden-variety opposition, and their eradication should not prove particularly challenging, although their magic resistance may stymie spellcasters under 20th level.

#### **Dragons**

While most dragons can be challenging adversaries, particularly in large groups, proper use of the *footman's dragonlance* can minimize their hazard to the party. Alternatively, dispersing widely and casting powerful *fireball* (*lightning bolt*, underwater) spells should prevail over most dragon encounters.

#### **Chromatic Dragon**

The form created to house the Dark Queen's spirit is likely to be the most challenging single opponent in the game. The dragon's body is invulnerable, and its five heads, which must be individually slain, are not far behind. The new-born monster cannot move or attack with its claws, and it lacks the wit to cast spells, but each of the heads can breathe and has a potent bite attack. Fortunately, there is an opportunity after returning

from the Abyss to cast preparatory spells before engaging the gargantuan beast. A single strong, hasted, high-level warrior with the *footman's dragonlance* can slay four of the five heads in the first round of combat, with a little luck. Luck is also required to defeat the chromatic dragon's magic resistance, although no amount of luck helps a spellcaster under about 25th level.

#### **Ettin**

Ettin are not a major threat; they have no special capabilities.

#### **Eye of the Deep**

The blinding ray, *hold person*, and *hold monster* spells of these undersea cousins of the beholder make them somewhat difficult to deal with, but they can be overcome with the use of *lightning bolt* and *cone of cold* spells.

#### **Fire Elemental**

These rampaging flame-creatures are immune to fire attacks, but other forms of magic should work well to overcome them.

#### **Fire Giant**

Potent adversaries, these brutes can inflict a great deal of damage, and their mages and clerics can harass your spellcasters fairly effectively, if not neutralized by missile attacks. They are immune to fire damage, but other kinds of spells work just fine against them.

#### **Fire Minion**

Puny relatives of the fire elemental, these creatures are healed by *fireball* spells and project an aura of fire which can damage adjacent characters. They take doubled damage from *cone of cold* spells and *wands of cold*, though, and they die quickly in melee.

#### **Fireshadow**

These malevolent spirits from the elemental plane of fire can be dangerous opponents. They share the fire minion's immunity to fire and fiery aura, and their ray of oblivion and green fire attacks can do serious harm. They take no damage from non-magical weapons. A *mace of disruption* is the preferred weapon against fireshadows, as it does double damage and has 50% chance of destroying them outright. Non-fire spells should also be used to kill fireshadows quickly. Heal characters afflicted by green fire immediately after the end of combat, as the damage from this aura quickly slays any character who is not fully cured.

#### **Gas Spore**

Don't confuse these benign balloons with beholders, and they won't bother your party.

#### **Ghast**

These weak undead can be defeated with minimal effort.

#### **Giant Anemone**

These undersea foes take a lot of damage to kill, and they can paralyze foes and do a great deal of damage to attackers, but they are immobile and completely impotent against opponents who are not adjacent, so you can defeat them at your leisure with *magic missile*, *lightning bolt*, and *cone of cold* spells. Giant anemones can regenerate lost hit points, but not quickly enough to be a serious nuisance.

#### **Giant Squid**

These vast, fast-moving cephalopods can attack with a multitude of tentacles, and they attempt to wrap tentacles around a chosen victim, pinning

the victim in place and inhibiting counterattacks. Otherwise, giant squid are not particularly dangerous opponents, and they can be dealt with in the same fashion as any other underwater monster.

#### **Gorgon**

The carnivorous bulls are not particularly ferocious, but their petrifying breath makes them respectable opponents, particularly when they are accompanied by tougher monsters.

#### **Greater Otyugh**

These filth-wallowers are large and capable of inflicting significant damage, but they have no special defensive capabilities.

#### **Spectral Minion**

These haunting spirits rarely oppose the party in combat, but they are tough opponents when they fight. They are immune to attacks by non-magical weapons, as well as cold, paralysis, charm, or death magic, but fire spells work quite handily.

#### **Huge Bat**

Huge bats have no special capabilities.

#### **Huge Crocodile**

These reptiles do lots of damage with their vast maws and slashing tails, but are not otherwise troublesome.

#### **Hydra**

These many-headed beasts attack multiple times and can sustain substantial damage, but are not otherwise distinguished.

*"Dealing with Monsters" continues...*

**Iron Golem**

These animated statues are unaffected by all magic except fire, which heals them, and *lightning bolt* spells, which slow them down. They are also unaffected by weapons with a bonus less than +3. They are heavy hitters and take a while to kill, but proper tactics overcome them without much difficulty. Prepare your fighters with *enlarge*, *bless*, *prayer*, and *haste*, if necessary, and then charge in and slow the golems down with *lightning bolt* spells as you gang up and chop them down, one at a time.

**Lich**

These undead mages are immune to lightning, as well the forms of magic which don't affect other high-level undead — cold, charm, hold, confusion, fear, paralysis, poison, and death. *Delayed blast fireball* spells should work fine, however, and high-level clerics have a fair chance of turning them. Try to keep liches from casting spells on the party.

**Minotaur**

Minotaur warriors are rather tough fighters, especially the champions, but they have no special protection from magic. If there are minotaur mages present in a battle, concentrate on eliminating them before cleaning up the fighters; they are not as well protected against magic as human wizards, but they have more hit points, and they can cast unpleasant spells on the party.

**Mummy**

The paralysis these shambling undead can evoke and the rotting sickness they can induce do not make mummies terribly powerful opponents. They have the usual undead magical immunities, but they can be turned fairly easily.

**Purple Worm**

These are large, powerful vermin, and their poisonous stings make trifling with them somewhat risky, but they have no special protection against magic and they are easy to hit.

**Salamander**

These fire creatures are immune to fire, charm, and hold magic, but they are especially vulnerable to cold spells. They are not very fearsome opponents.

**Sahuagin**

Except for their leader, Prince Talhook, these undersea warriors are pushovers, although it is wise to keep their priestesses from casting spells each round. Prince Talhook is a mighty warrior who can be dealt with using underwater magic or melee attacks, but he may inflict significant damage before he is slain.

**Sea Snake**

These vast serpents are completely vulnerable to *snake charm*, but each spell is only likely to immobilize one or two snakes, so keep a number of the spells ready through the entire undersea portion of the game, if possible. *Snake charm* is of no use during the rest of the game, but *resist fire* is useless underwater, so the two spells can be traded off between realms.

**Shambling Mound**

These hulking, herbaceous horrors are immune to fire, healed by lightning, take half or no damage from cold, minimal damage from blunt weapons, and half damage from other weapons. *Magic missile* and *ice storm* spells are effective ways to damage them, and they succumb to melee attacks eventually. Ganging up on a shambling mound is a good way to keep it from suffocating a character it has engulfed.

**Skeleton Warrior**

These undead lords have the usual undead magical immunities and cannot be turned by clerics. Their high magic resistance may interfere with spells below 30th level, they are immune to attacks with nonmagical weapons, and they take half damage from thrusting and slashing weapons. If your mages are below 20th level, spells won't do much good, so cast preparatory spells before fighting them, if possible, and gang up on individual skeleton warriors and arrange things so your thieves can backstab one every round.

**Spectre, Vampire, Wight, Wraith**

These undead are all nasty because they drain experience levels when they hit, although the experience levels may be recovered with a *restoration* spell. They have the usual undead magical immunities, and high-level clerics should be able to turn most of them. Vampire clerics and mages can cast spells.

**Spider (Enormous Spider and Whisper Spider)**

Poisonous bites make it desirable to slay these scuttling horrors quickly, but they have no special defenses to make this task particularly challenging.

**Two-Headed Troll**

These lumbering beasts are very similar to ettins, although they also regenerate damage, albeit very slowly.

**Umber Hulk**

The gaze of these bulky beasts can temporarily immobilize party members, but they have no defenses against magic and only the weakest of parties should have substantial difficulties in dealing with them.

**Wyndlass**

These subterranean behemoths can do a great deal of damage with their spiked tentacles, but they fall quickly to determined attacks.

**Zombie**

These weak undead can be defeated with minimal effort.

**Zombie Minotaur**

More powerful than a zombie but less powerful than a minotaur, these undead fighters can easily be turned or defeated by most parties.

## CREDITS

Producer  
**George MacDonald**

Associate Producer  
**Ken Humphries**

Writers  
**MicroMagic Inc.: Herb Perez, Kiri Naiman**

Other Contributors  
**MicroMagic Inc.: Ken Eklund, Francis Small, David Arcand,  
Stephen Linhart, Wayne Horgan**

Editors  
**SSI Tech Writing**

Testing  
**John Boockholdt, Forrest Elam, Cyrus Harris, John Kirk, Zane Wolters**

Test Support  
**Kym Goyer**

Art, Graphic Design, and Desktop Publishing  
**Louis Saekow Design: David Boudreau, Kathryn Lee, and Chris Mischak**

Pre-press Production  
**Louis Saekow Design: Kirk Nichols and Jev Rothe**

Printing  
**American Lithographers, Inc.**

# Elevate yourself to a higher level of fantasy gaming!

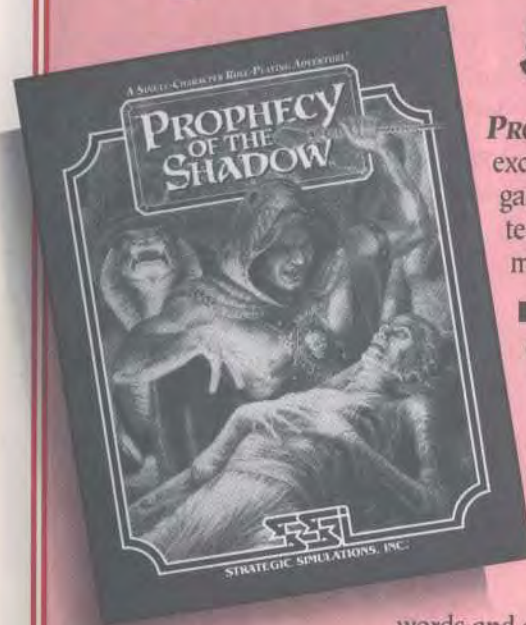

**PROPHECY OF THE SHADOW** is SSI's exciting single-character role-playing game that uses state-of-the-art technology to breathe life into a mystical fantasy.

■ **Stunning cinematics** with over fifty digitized art and animation sequences, including characters in full costume.

■ **Simple point-and-click interface** with icon-based commands and graphical inventories makes the game fast and easy to play. Learn

words and converse from an icon bar by simply clicking on the word.

■ **Over 50 sound effects** and a continuous FM soundtrack enhance the action.

■ **Three perspective viewpoints:** An *adventure view* allows you to explore this exciting world and engage in combat; an *up-close-and-personal mode* lets you converse with Non-Player Characters; and through the use of magic, an *eagle's view* of the world.

■ **A large, complex world** – both above and below ground – that you must save!

**IBM & AMIGA – \$59<sup>95</sup>**

By Jaimi McEntire.

#### TO ORDER:

VISA/MC – call 1-800-245-4525 (USA & Canada). By mail – send check or money order for \$59.95 plus \$4.00 shipping & handling to: *Electronic Arts, P.O. Box 7530, San Mateo, CA 94403*

CA residents add applicable sales tax. Specify computer format. Allow 1-3 weeks for delivery



**STRATEGIC SIMULATIONS, INC.®**